

Surgical Instruments Catalogue

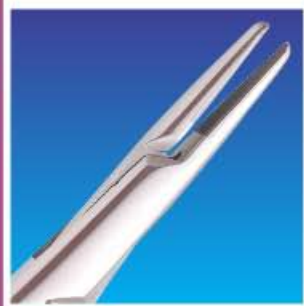

HOMEDICA
INTERNATIONAL



HOMEDICA INTERNATIONAL

Homedica feels great honor introducing itself to be one of the leading manufacturing company of surgical & dental instruments. Professional always prefer Homedica instruments, which is our pride.

Our all instruments are manufactured by the high quality stainless steel made on our requirements, every instrument is hand crafted with the highest workmanship available in the industry. Through heat treatment, the instruments are hardened and tempered for proper functioning and long life. All instruments are polished electrolytically and manually for maximum resistance to corrosion and long life. Homedica pays special attention to the needs of doctors, with innovative designs to meet the needs of professionals. The wide assortment of standard patterns and exclusive Homedica designs gives you the most desirable range of surgical and dental instruments.

Over the several years, we have earned the reputation of for maintaining highest quality standards of quality and service. To manufacture instruments that meet with your changing demands is our achievement. Our highly skilled staff of professionals will continue to serve your needs and will try their outmost to uplift the standards which we have set in the past.

With your co-operation and guidance, Homedica will continue serving surgical and dental instruments in future.

Management of Homedica international

BASIC METHODS FOR HANDLING AND CARE OF SURGICAL AND DENTAL INSTRUMENTS

Dear Customers:

We have received some questions concerning staining, pitting or rusting in stainless steel instruments. So, we took great honour and pleasure in guiding our respected customers to eliminate the problems about staining or rusting etc. The points are as follows:-

- 1) Rinse the instruments as soon as possible after use to remove blood and serum.
- 2) Dry the instruments after cleaning or before wrapping and storing, if not so, moisture left can cause rust and corrosion.
- 3) Do not leave instruments in cold sterilization solution for a long period, as the solution may lead the instrument to be corrosive.
- 4) Never use caustic cleaners, use those specified for cleaning surgical instruments.
- 5) Avoid cleaning instruments with steel wool; if want to clean with hand, use detergent soap and a soft brush and finally treat with distilled water.
- 6) You should check your autoclave; Iron, calcium, sodium or copper in water can cause rusting, staining or corrosion.
- 7) Leaving of instruments for a long time in the following solutions can also cause corrosion.
 - i) Phenol or Iodine.
 - ii) Aluminium, Barium or Calcium.
 - iii) Any Acid, Mercury or Potassium solution.
- 8) Try your utmost not to sterilize stainless steel instrument with chrome plated brass instruments, as any break in chrome surface may cause pitting or rusty surface in instruments.
- 9) Muslin wraps should be rinsed sufficiently by the laundry, so that all chlorine bleach may remove, which can cause corrosion or custing during autoclaving.

We hope that by acting on the above instructions, your problems relating to rusting, staining or pitting would abolish and the age of your instrument would increase.

MANAGEMENT

UROLOGY INSTRUMENTS



KIDNEY STONE FORCEPS



Nierensteinzangen | Pincés pour les calculs du bassinét
Pinzas para cálculoa renales | Pinze per calcoli renali



Randall Kidney Stone Clamps Forceps

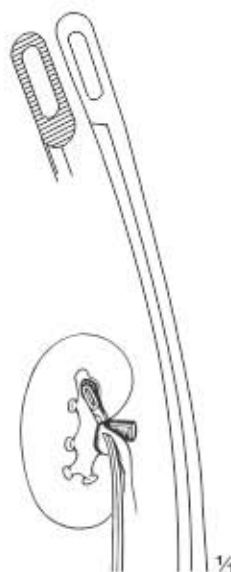

HI-14-001
23 cm, 9"
quarter curved

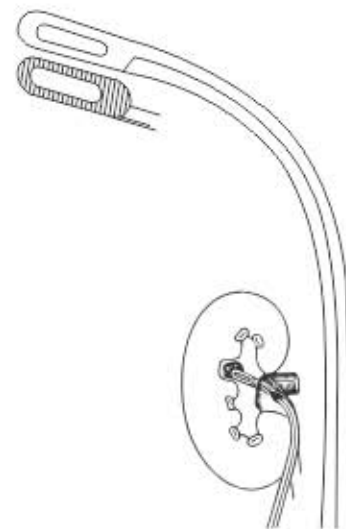

HI-14-002
23 cm, 9"
half curved

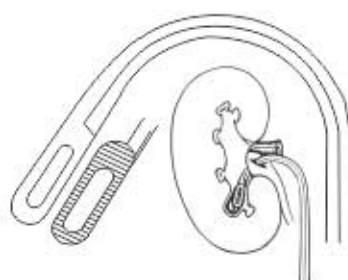

HI-14-003
23 cm, 9"
full curved

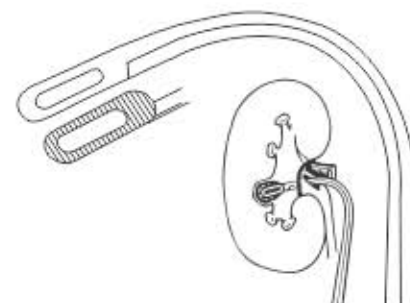

HI-14-004
23 cm, 9"
three quarter curved



Dartigues Uterine Elevating Forceps
HI-14-005
27 cm, 10 3/4"



Collin Kidney Elevating Stone Clamps Forceps
HI-14-006
28.5 cm, 11 1/4"



Hulka-Kenwick Uterine Elevating & Manipulating Forceps
HI-14-007
27.3 cm, 11"



Sommer Kidney Elevating Stone Clamps Forceps
HI-14-008
23.5 cm, 9"



Strassmann Kidney Elevating Stone Clamps Forceps
HI-14-009
26 cm, 10 1/4"



Collin Kidney Elevating Stone Clamps Forceps
HI-14-010
26.5 cm, 10 1/2"

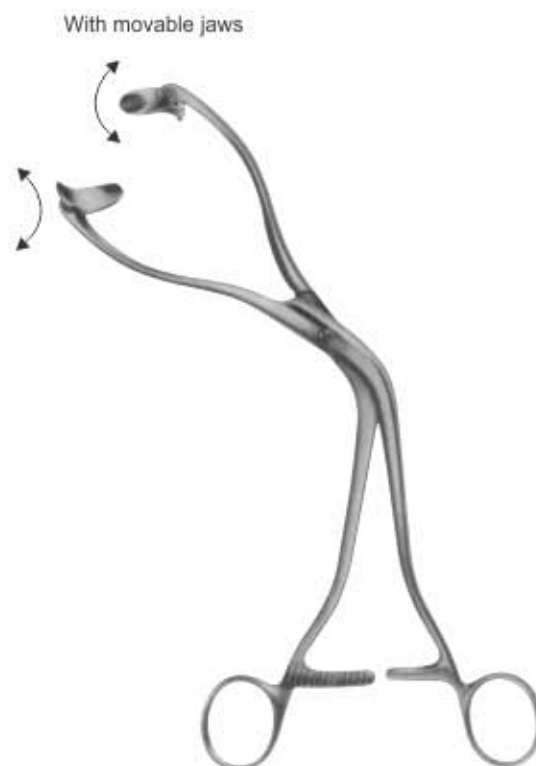

Collin Kidney Elevating Stone Clamps Forceps
HI-14-011
26 cm, 10 1/4"

PROSTATIC RETRACTOR



Prostatahaken

Ecarteurs prostatiques

Separadores para próstata

Divaricatori prostatici

11 x 50 mm

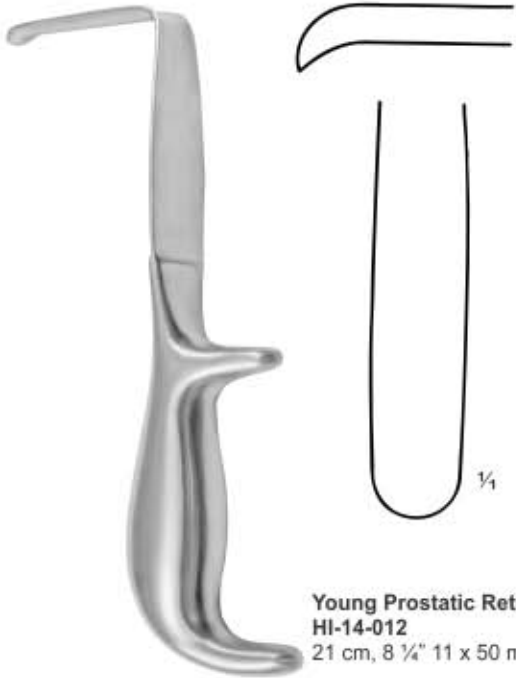

Young Prostatic Retractor
HI-14-012
21 cm, 8 1/4" 11 x 50 mm

38 x 64 mm

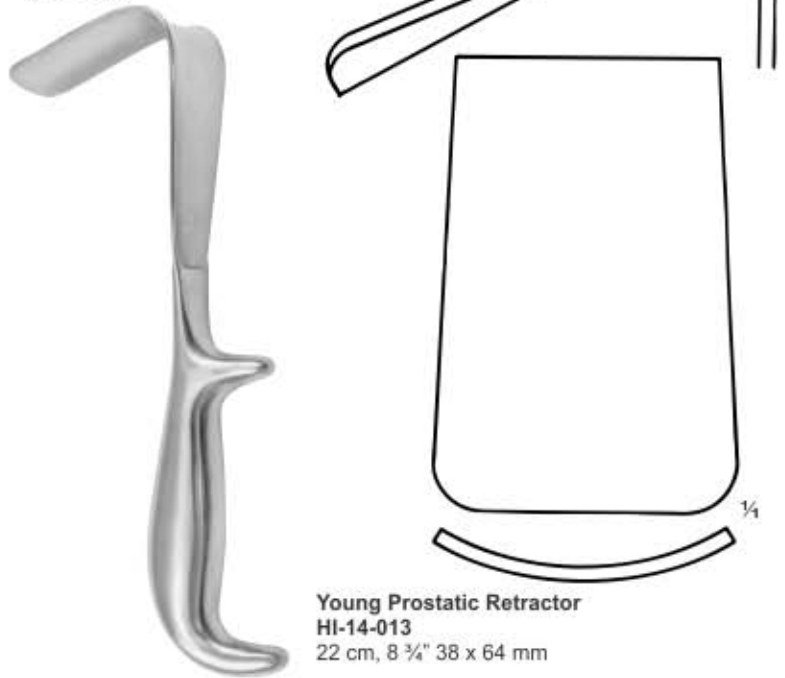

Young Prostatic Retractor
HI-14-013
22 cm, 8 3/4" 38 x 64 mm

25 x 25 mm

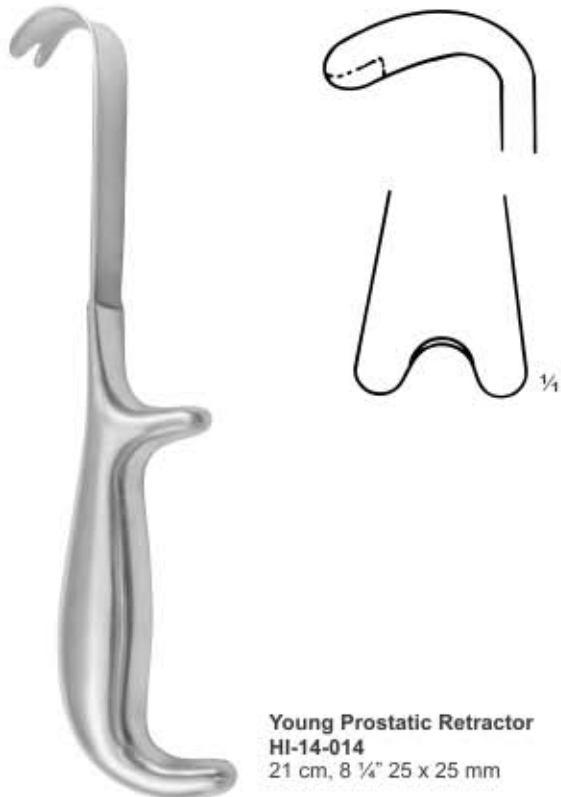

Young Prostatic Retractor
HI-14-014
21 cm, 8 1/4" 25 x 25 mm

39 x 35 mm

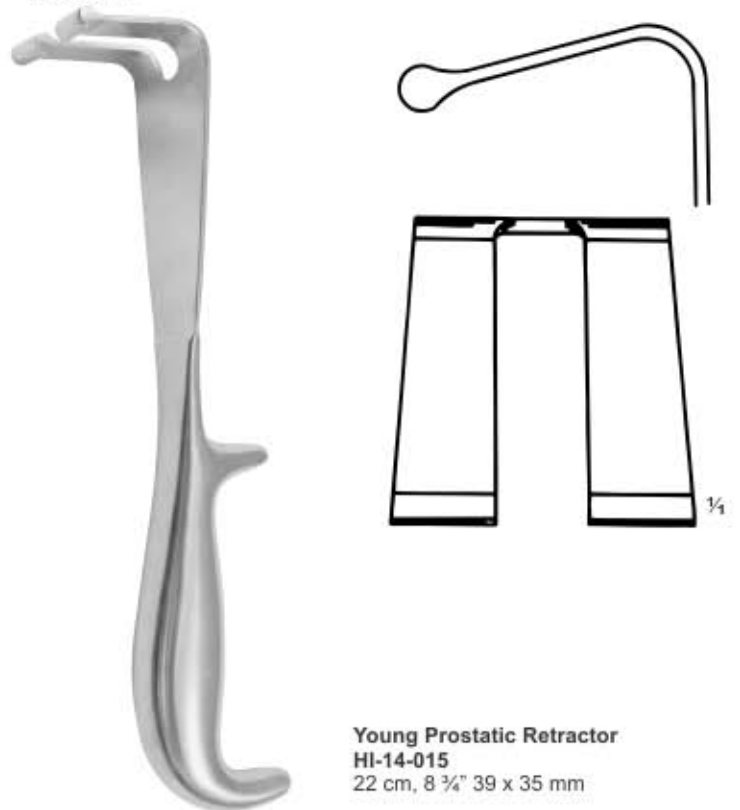

Young Prostatic Retractor
HI-14-015
22 cm, 8 3/4" 39 x 35 mm

GALL DUCT DILATOR

Gallenkanaldilatatoren | Dilateurs pour les voies biliaires
 Gallensteinzangen | Pinces pour calculs biliaires



**Desjardins Probe
& Catch with flexible
shaft 28 cm, 11"**



HI-14-016
17 F.G.



HI-14-017
21 F.G.



HI-14-018
24 F.G.



HI-14-019
27 F.G.



**Moynihan
HI-14-020
34.0 cm, 13 1/2"**



**Bakes Common Bile
Duct Dilators, Malleable
Set of 13, 32 cm, 13"**



Fig. 1
HI-14-021



Fig. 4
HI-14-024



Fig. 7
HI-14-027



Fig. 10
HI-14-030



Fig. 2
HI-14-022



Fig. 5
HI-14-025



Fig. 8
HI-14-028



Fig. 11
HI-14-031



Fig. 3
HI-14-023



Fig. 6
HI-14-026



Fig. 9
HI-14-029



Fig. 12
HI-14-032



Fig. 13
HI-14-033



**Luer-Koerte
Modif With
Malleable Shaft
31 cm, 12.20"**



HI-14-034
2.8mm
Fig. 000



HI-14-035
3.4mm
Fig. 00



HI-14-036
4.3mm
Fig. 0



HI-14-037
5.5mm
Fig. 1



HI-14-038
6.7mm
Fig. 0



HI-14-039
8.0mm
Fig. 3



HI-14-040
11mm
Fig. 4



HI-14-041
15mm
Fig. 5

URETHRAL CATHETERS

Urethalkatheter | Cateteri Uretrali
Sondes Urétrales | Catéteres Uretrales



Catheter
HI-14-042
15 cm, 6"
No. 6-16



Catheters
HI-14-043 29 cm, 11 1/2"
Male Catheters charr., Metal
French
HI-14-044 8
HI-14-045 10
HI-14-046 12
HI-14-047 14
HI-14-048 16
HI-14-049 18
HI-14-050 20



Lister Bougies
HI-14-051
27 cm, 10 3/4"
00 / 1 to 15 / 18
set of 17



Clutton Bougies
HI-14-052 27 cm, 10 3/4"
06 / 10 FG to 28 / 32
set of 12



Van Buren
Urethral Sound
A TO O
Set of 15

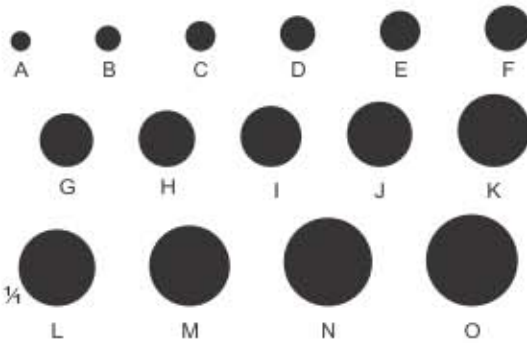
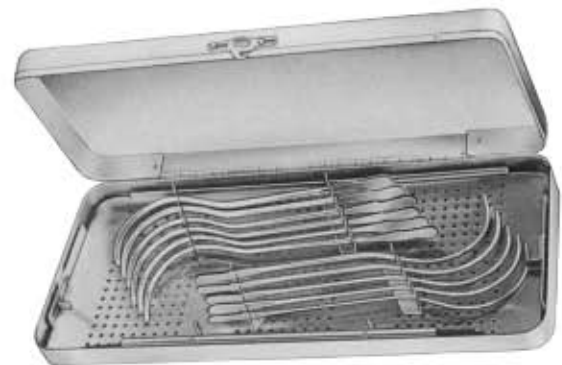

Fig.	Item	Description	Inches	Dia. Charr
A	HI-14-053	28 cm	11"	8 French
B	HI-14-054	28 cm	11"	10 French
C	HI-14-055	28 cm	11"	12 French
D	HI-14-056	28 cm	11"	14 French
E	HI-14-057	28 cm	11"	16 French
F	HI-14-058	28 cm	11"	18 French
G	HI-14-059	28 cm	11"	20 French
H	HI-14-060	28 cm	11"	22 French
I	HI-14-061	28 cm	11"	24 French
J	HI-14-062	28 cm	11"	26 French
K	HI-14-063	28 cm	11"	28 French
L	HI-14-064	28 cm	11"	30 French
M	HI-14-065	28 cm	11"	32 French
N	HI-14-066	28 cm	11"	34 French
O	HI-14-067	28 cm	11"	36 French



Guyon
HI-14-068
420 x 175 x 40 mm
Set in metal case containing:
— 21 Bougies Guyon
— 6 filiform Bougies



Dittel
HI-14-069
22.5 cm, 8 3/4"
urethral bougies and
dilating sounds

Charr. (French)	
HI-14-070	8
HI-14-071	9
HI-14-072	10
HI-14-073	11
HI-14-074	12
HI-14-075	13
HI-14-076	14
HI-14-077	15
HI-14-078	16
HI-14-079	17
HI-14-080	18
HI-14-081	19
HI-14-082	20
HI-14-083	21
HI-14-084	22
HI-14-085	23
HI-14-086	24
HI-14-087	25
HI-14-088	26
HI-14-089	27
HI-14-090	28
HI-14-091	29
HI-14-092	30



Dittel
HI-14-093
35 cm, 14"
urethral bougies and
dilating sounds

Charr. (French)	
HI-14-094	8
HI-14-095	9
HI-14-096	10
HI-14-097	11
HI-14-098	12
HI-14-099	13
HI-14-100	14
HI-14-101	15
HI-14-102	16
HI-14-103	17
HI-14-104	18
HI-14-105	19
HI-14-106	20
HI-14-107	21
HI-14-108	22
HI-14-109	23
HI-14-110	24
HI-14-111	25
HI-14-112	26
HI-14-113	27
HI-14-114	28
HI-14-115	29
HI-14-116	30



HI-14-217
33 cm, 13"
filiform guides,
olive tip

Charr. (French)	
HI-14-118	3
HI-14-119	4
HI-14-120	5
HI-14-121	6



Guyon
HI-14-122
25 cm, 10"
urethral bougies and
dilating sounds
without filiform guides,
with thread in tip

Charr. (French)	
HI-14-123	Ben. 24 / Charr. 12
HI-14-124	Ben. 25
HI-14-125	Ben. 26 / Charr. 13
HI-14-126	Ben. 27
HI-14-127	Ben. 28 / Charr. 14
HI-14-128	Ben. 29
HI-14-129	Ben. 30 / Charr. 15
HI-14-130	Ben. 31
HI-14-131	Ben. 32 / Charr. 16
HI-14-132	Ben. 33
HI-14-133	Ben. 34 / Charr. 17
HI-14-134	Ben. 35
HI-14-135	Ben. 36 / Charr. 18
HI-14-136	Ben. 37
HI-14-137	Ben. 38 / Charr. 19
HI-14-138	Ben. 39
HI-14-139	Ben. 40 / Charr. 20
HI-14-140	Ben. 41
HI-14-141	Ben. 42 / Charr. 21
HI-14-142	Ben. 43
HI-14-143	Ben. 44 / Charr. 22
HI-14-144	Ben. 45
HI-14-145	Ben. 46 / Charr. 23
HI-14-146	Ben. 47
HI-14-147	Ben. 48 / Charr. 24
HI-14-148	Ben. 49
HI-14-149	Ben. 50 / Charr. 25
HI-14-150	Ben. 51
HI-14-151	Ben. 52 / Charr. 26
HI-14-152	Ben. 53
HI-14-153	Ben. 54 / Charr. 27
HI-14-154	Ben. 55
HI-14-155	Ben. 56 / Charr. 28
HI-14-156	Ben. 57
HI-14-157	Ben. 58 / Charr. 29
HI-14-158	Ben. 59
HI-14-159	Ben. 60 / Charr. 30

GALL STONE FORCEPS



Gallensteinzangen | Pincettes pour calculs biliaires
 Gallensteinlöffel | Curettes pour calculs biliaires



Blake Gall Stone Forceps
 HI-14-160 20 cm, 8"
 Straight



Blake Gall Stone Forceps
 HI-14-161 20 cm, 8"
 Curved



Uro-Tangential Gall Stone Forceps



HI-14-162
 26 cm, 10 1/4"



HI-14-163
 26 cm, 10 1/4"



Mayo-Blake Gall Stone Forceps
 HI-14-164 20 cm, 8"
 Straight



Mayo-Blake Gall Stone Forceps
 HI-14-165 20 cm, 8"
 Curved



Mixer Gall Stone Forceps
 HI-14-166 22 cm, 8 3/4"



Desjardins Gall Stone Forceps
 HI-14-167 23 cm, 9"



Desjardins Gall Stone Forceps
 HI-14-168 23 cm, 9"

Leistenbruch Director, Vasektomie Zange, Schraubstock & Blase Retractor
Directora Hernia, Pinzas vasectomia, abrazadera y la vejiga retractor

Directeur de hernie, Pincas de vasectomie, Clamp et la vessie enrrouleur
Direttore Ernia, Pinze vasectomia, Clamp & vescica Divaricatore



Child Hernia Director
HI-14-169



Key Hernia Director
HI-14-170



Teale Hernia Director
HI-14-171



Millin Suction Tube
HI-14-172



Cord Hook
HI-14-173
blunt 16cm



Gutmann Secretions Scoop
HI-14-174 26cm



No Scalpel Vasectomy Ringed Forceps Clamps
HI-14-175 14cm, 5.5"



No Scalpel Vasectomy Hemostat Forceps
HI-14-176 14cm, 5.5"
smooth sharp point curved



Legueu Bladder Retractor
HI-14-177



Kocher's Bladder retractor
HI-14-178 23.5 cm, 9.25"

BLADDER NECK SPREADER, BLADDER RETRACTORS



Blasenhalsperrer, Blasenwundsperrer

Ecarteur pour le col de la vessie, Ecarteurs vésicaux

Dilatador para el cuello vesical, Separadores vesicales

Divaricatore del collo vescicale, Divaricatore vescicale



Knutson
HI-14-179
18 cm, 7"
Urethrographie-Instruments

HI-14-180
Spare



Winkelmann Circumcision Clamps
HI-14-181 12 mm Ø
HI-14-182 16 mm Ø
HI-14-183 20 mm Ø



Mogen Circumcision Clamp
HI-14-184

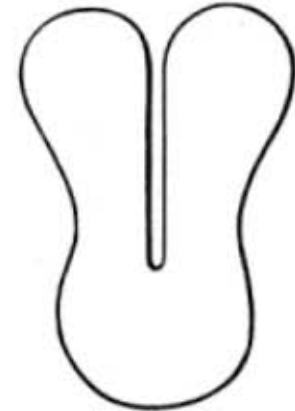

Circumcision Shield
HI-14-185
10cm

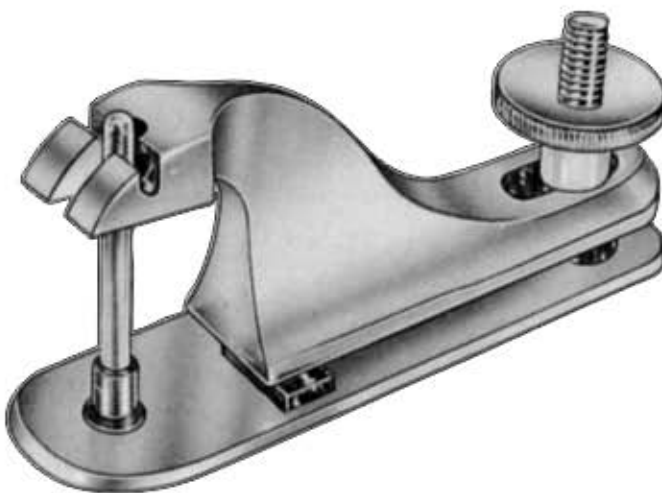

Gumco Circumcision Clamp

	mm Ø
HI-14-186	8
HI-14-187	11
HI-14-188	13
HI-14-189	16
HI-14-190	21
HI-14-191	26
HI-14-192	32



Stockmann Penile Clamp
HI-14-193 8cm

Blasenhalsperrer, Blasenwundsperrer

Ecarteur pour le col de la vessie, Ecarteurs vésicaux

Dilatador para el cuello vesical, Separadores vesicales

Divaricatore del collo vescicale, Divaricatore vescicale



Legueu Bladder Spatula
HI-14-194



Gosset Bladder Retractor
HI-14-195 160mm



Thomson Walker Bladder Retractor
HI-14-196

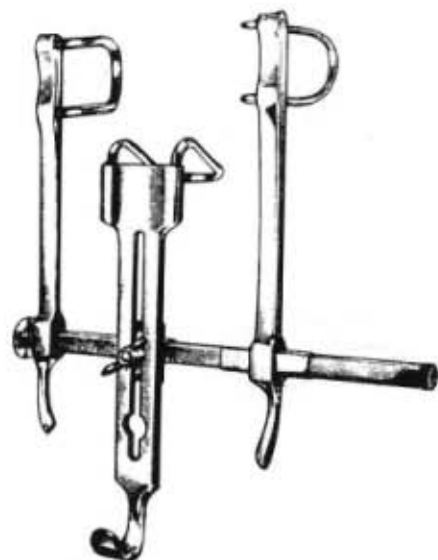

Pantings Bladder Retractor
HI-14-197



Judd Masson Bladder Retractor
HI-14-198
w/center blade



Millin Bladder Neck Spreader
HI-14-199
28 cm, 11"

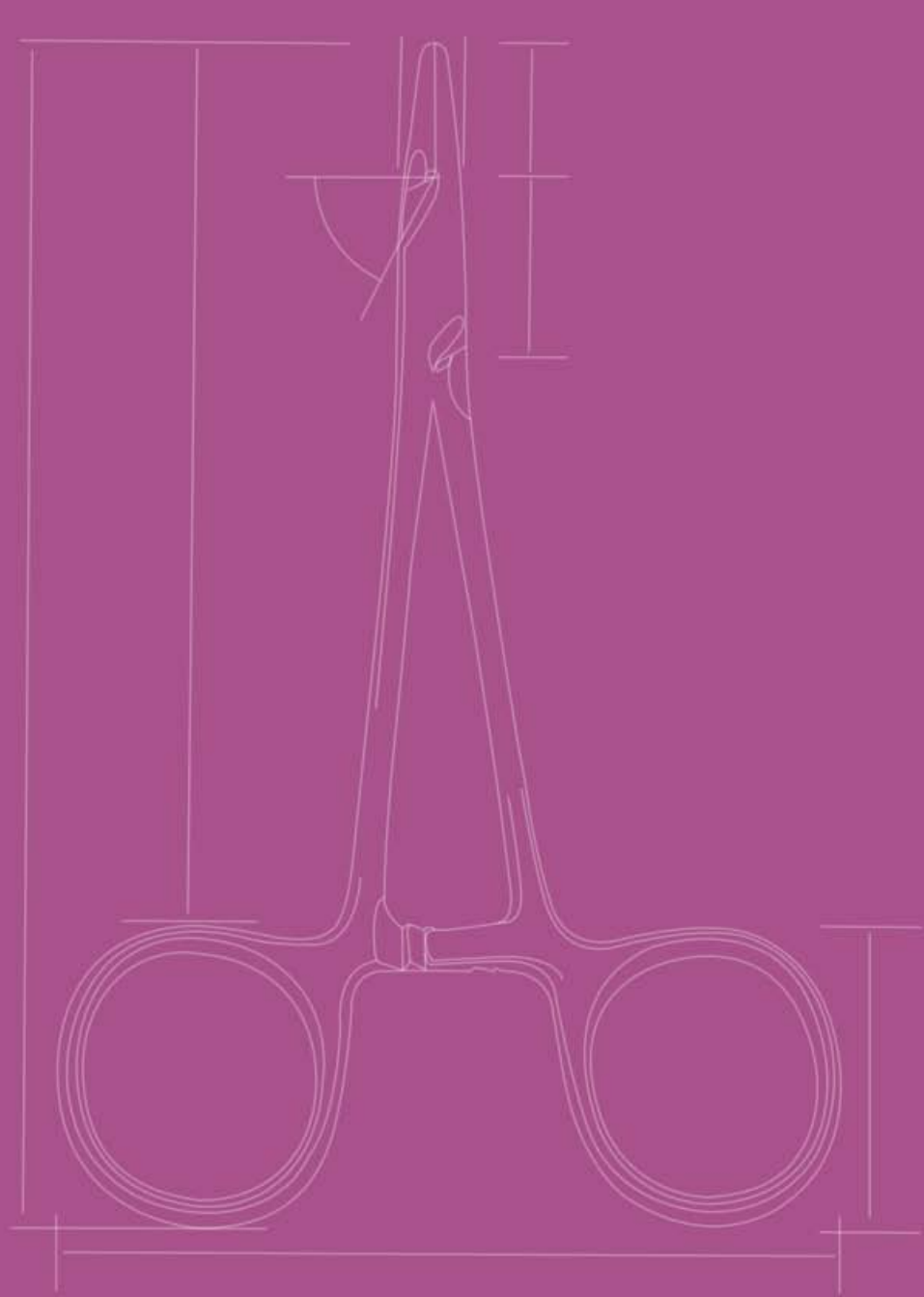

HOMEDICA
INTERNATIONAL