

Surgical Instruments Catalogue

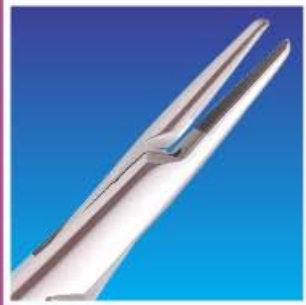

HOMEDICA
INTERNATIONAL



HOMEDICA INTERNATIONAL

Homedica feels great honor introducing itself to be one of the leading manufacturing company of surgical & dental instruments. Professional always prefer Homedica instruments, which is our pride.

Our all instruments are manufactured by the high quality stainless steel made on our requirements, every instrument is hand crafted with the highest workmanship available in the industry. Through heat treatment, the instruments are hardened and tempered for proper functioning and long life. All instruments are polished electrolytically and manually for maximum resistance to corrosion and long life. Homedica pays special attention to the needs of doctors, with innovative designs to meet the needs of professionals. The wide assortment of standard patterns and exclusive Homedica designs gives you the most desirable range of surgical and dental instruments.

Over the several years, we have earned the reputation of for maintaining highest quality standards of quality and service. To manufacture instruments that meet with your changing demands is our achievement. Our highly skilled staff of professionals will continue to serve your needs and will try their outmost to uplift the standards which we have set in the past.

With your co-operation and guidance, Homedica will continue serving surgical and dental instruments in future.

Management of Homedica international

BASIC METHODS FOR HANDLING AND CARE OF SURGICAL AND DENTAL INSTRUMENTS

Dear Customers:

We have received some questions concerning staining, pitting or rusting in stainless steel instruments. So, we took great honour and pleasure in guiding our respected customers to eliminate the problems about staining or rusting etc. The points are as follows:-

- 1) Rinse the instruments as soon as possible after use to remove blood and serum.
- 2) Dry the instruments after cleaning or before wrapping and storing, if not so, moisture left can cause rust and corrosion.
- 3) Do not leave instruments in cold sterilization solution for a long period, as the solution may lead the instrument to be corrosive.
- 4) Never use caustic cleaners, use those specified for cleaning surgical instruments.
- 5) Avoid cleaning instruments with steel wool; if want to clean with hand, use detergent soap and a soft brush and finally treat with distilled water.
- 6) You should check your autoclave; Iron, calcium, sodium or copper in water can cause rusting, staining or corrosion.
- 7) Leaving of instruments for a long time in the following solutions can also cause corrosion.
 - i) Phenol or Iodine.
 - ii) Aluminium, Barium or Calcium.
 - iii) Any Acid, Mercury or Potassium solution.
- 8) Try your utmost not to sterilize stainless steel instrument with chrome plated brass instruments, as any break in chrome surface may cause pitting or rusty surface in instruments.
- 9) Muslin wraps should be rinsed sufficiently by the laundry, so that all chlorine bleach may remove, which can cause corrosion or custing during autoclaving.

We hope that by acting on the above instructions, your problems relating to rusting, staining or pitting would abolish and the age of your instrument would increase.

MANAGEMENT

NEEDLE HOLDERS



NEEDLE HOLDERS

Nadelhalter | Porta-agujas
 Prote-aiguilles | Porta aghi

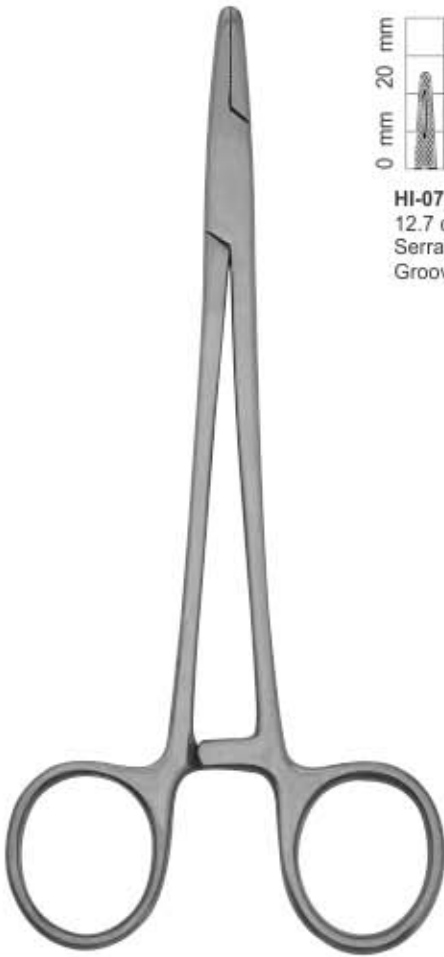

Mayo-Hegar
Needle Holders

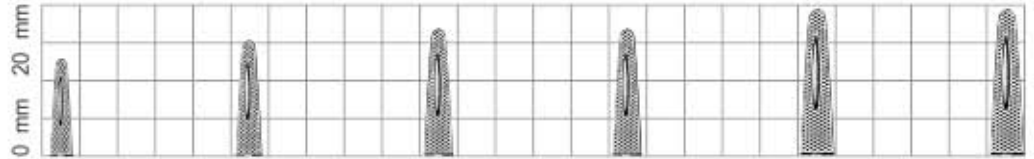

HI-07-001
12.7 cm, 5"
Serrated-
Grooved

HI-07-002
14 cm, 5 1/2"
Serrated-
Grooved

HI-07-003
15.2 cm, 6"
Serrated-
Grooved

HI-07-004
15.2 cm, 6"
Serrated-
Grooved
left handed

HI-07-005
17.8 cm, 6 1/4"
Serrated-
Grooved

HI-07-006
17.8 cm, 6 1/4"
Serrated-
Grooved
left handed

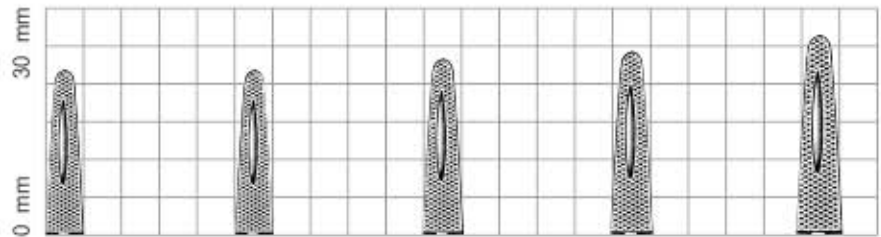

HI-07-007
20.3 cm, 8"
Serrated-
Grooved

HI-07-008
20.3 cm, 8"
Serrated-
Grooved
left handed

HI-07-009
24.8 cm, 9 3/4"
Serrated-
Grooved

HI-07-010
26 cm, 10 1/4"
Serrated-
Grooved

HI-07-011
30.5 cm, 12"
Serrated-
Grooved

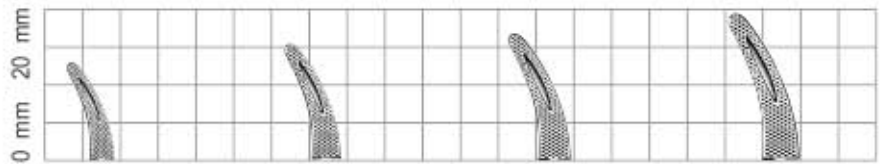

HI-07-012
12.7 cm, 5"
Serrated-
Grooved
Curved

HI-07-013
14 cm, 5 1/2"
Serrated-
Grooved
Curved

HI-07-014
15.2 cm, 6 1/4"
Serrated-
Grooved
Curved

HI-07-015
17.8 cm, 7"
Serrated-
Grooved
Curved

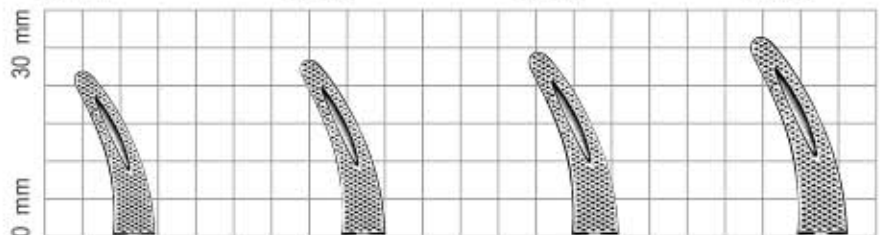

HI-07-016
20.3 cm, 8"
Serrated-
Grooved
Curved

HI-07-017
24.8 cm, 9 3/4"
Serrated-
Grooved
Curved

HI-07-018
26 cm, 10 1/4"
Serrated-
Grooved
Curved

HI-07-019
30.5 cm, 12"
Serrated-
Grooved
Curved

NEEDLE HOLDERS

Nadelhalter | Porta-agujas
 Prote-aiguilles | Porta aghi



BAUMGARTNER
Needle Holder



HI-07-020
12.7 cm, 5"
Serrated-Solid

HI-07-021
14 cm, 5 1/2"
Serrated-Solid

HI-07-022
16 cm, 6 1/4"
Serrated-Solid

HI-07-023
17.8 cm, 7"
Serrated-Solid

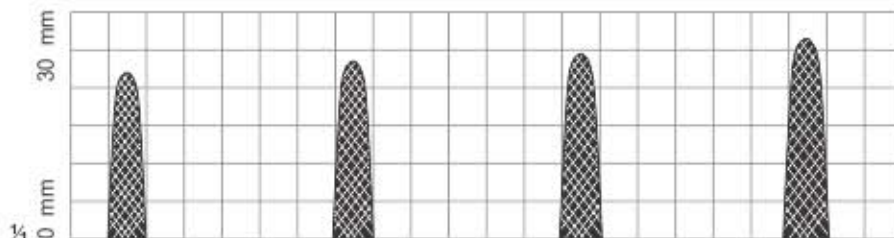

HI-07-024
20.3 cm, 8"
Serrated-Solid

HI-07-025
24.8 cm, 9 3/4"
Serrated-Solid

HI-07-026
26 cm, 10 1/4"
Serrated-Solid

HI-07-027
30.5 cm, 12"
Serrated-Solid



WEBSTER
Needle Holder



HI-07-028
11.4 cm, 4 1/2"
Smooth

HI-07-029
12 cm, 4 3/4"
Smooth

HI-07-030
12.7 cm, 5"
Smooth

HI-07-031
13.3 cm, 5 1/4"
Smooth

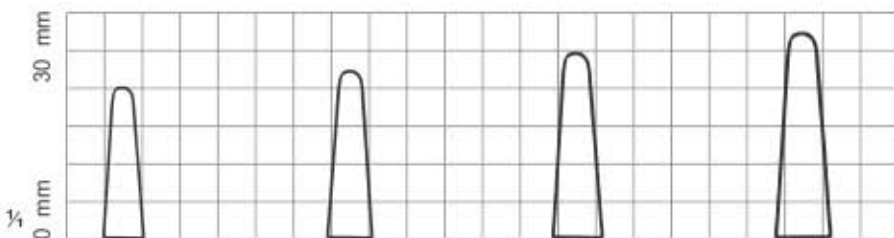

HI-07-032
14 cm, 5 1/2"
Smooth

HI-07-033
15.2 cm, 6"
Smooth

HI-07-034
17.8 cm, 7"
Smooth

HI-07-035
20.3 cm, 8"
Smooth

NEEDLE HOLDERS

Nadelhalter | Porta-agujas
 Prote-aiguilles | Porta aghi



BROWN
Needle Holder

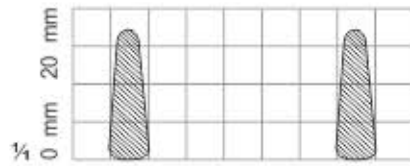

HI-07-036
13.3 cm, 5 1/4"
Serrated-Solid

HI-07-037
19.1 cm, 7 1/2"
Serrated-Solid



BABY CRILE-WOOD
Needle Holder

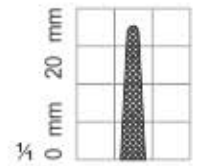

HI-07-038
15 cm, 6"



CRILE-WOOD
Needle Holder

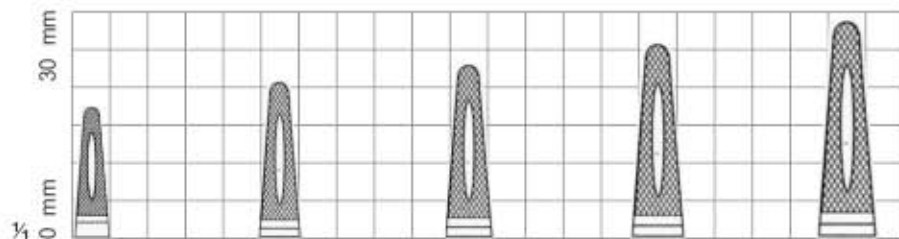

HI-07-039
15.2 cm, 6"
grooved serrated

HI-07-040
17.8 cm, 7"
grooved serrated

HI-07-041
20.3 cm, 8"
grooved serrate

HI-07-042
22.3 cm, 8 3/4"
grooved serrated

HI-07-043
25.4 cm, 10"
grooved serrated

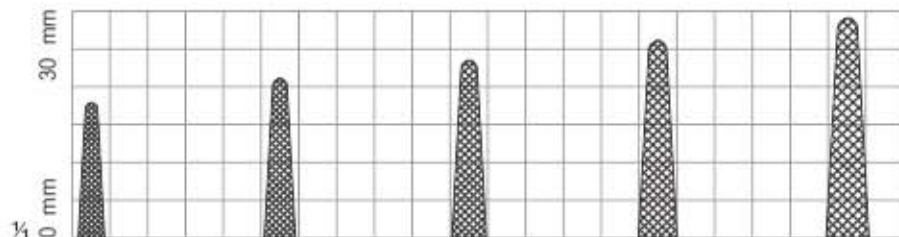

HI-07-044
15.2 cm, 6"
solid serrated

HI-07-045
17.8 cm, 7"
solid serrated

HI-07-046
20.3 cm, 8"
solid serrated

HI-07-047
22.3 cm, 8 3/4"
solid serrated

HI-07-048
25.4 cm, 10"
solid serrated

NEEDLE HOLDERS

Nadelhalter | Porta-agujas
 Prote-aiguilles | Porta aghi



Sarot Needle Holders

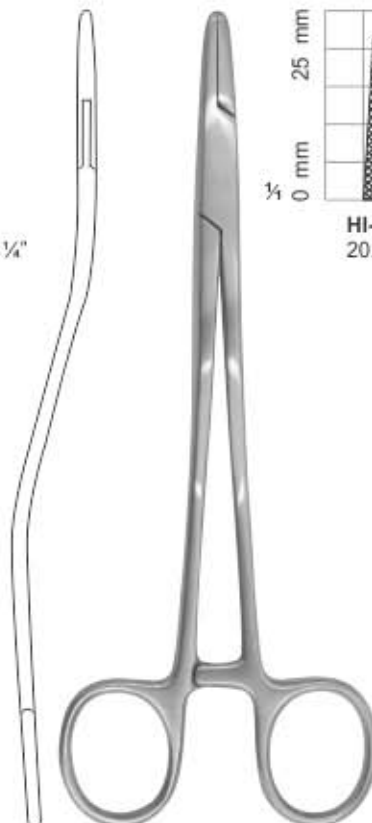
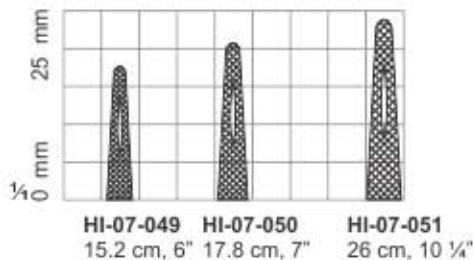

Bozemann Needle Holders

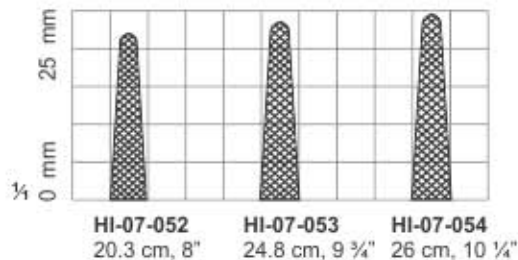

HI-07-048

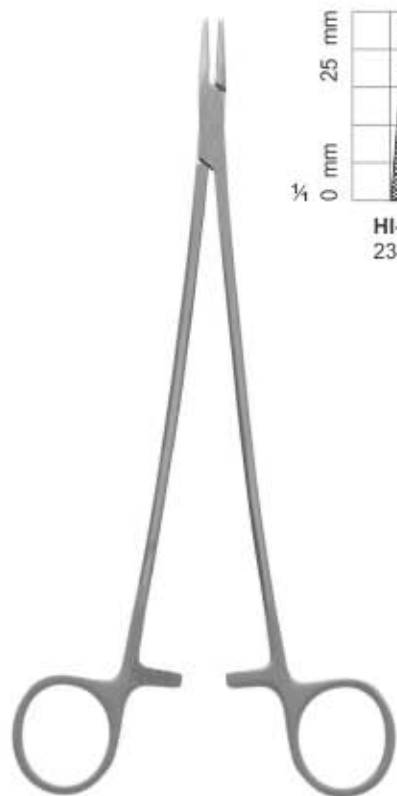

Jameson Needle Holders

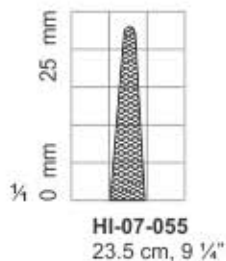

Finocchietto Needle Holders

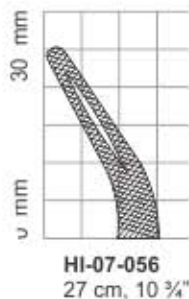

Mass. General Hospital
 Needle Holders

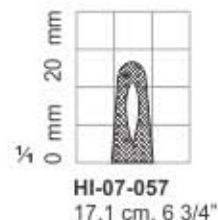

NEEDLE HOLDERS

Nadelhalter | Porta-agujas
 Prote-aiguilles | Porta aghi



HI-07-058
 17.8 cm, 7"

Adson Needle Holders



HI-07-059
 18 cm, 7"

New Orleans Needle Holders

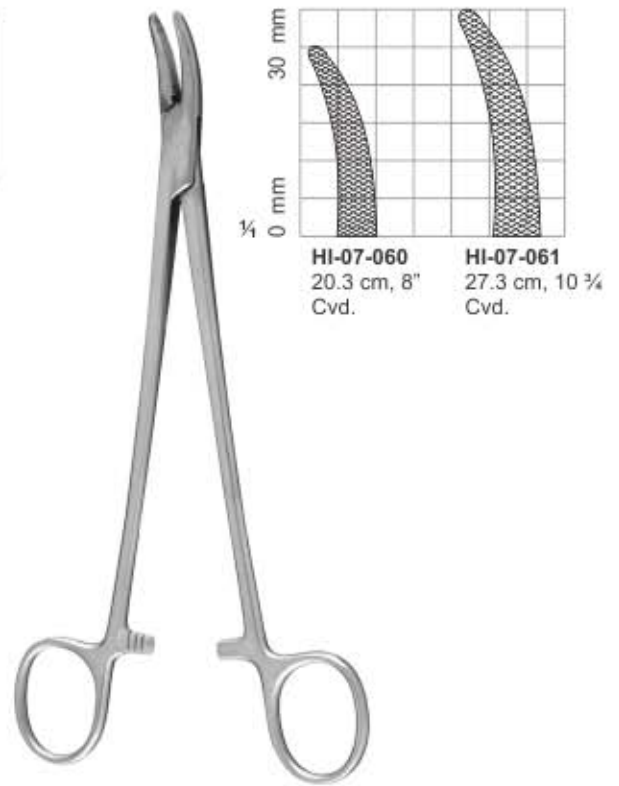

HI-07-060
 20.3 cm, 8"
 Cvd.

HI-07-061
 27.3 cm, 10 1/4"
 Cvd.

Heaney Needle Holders

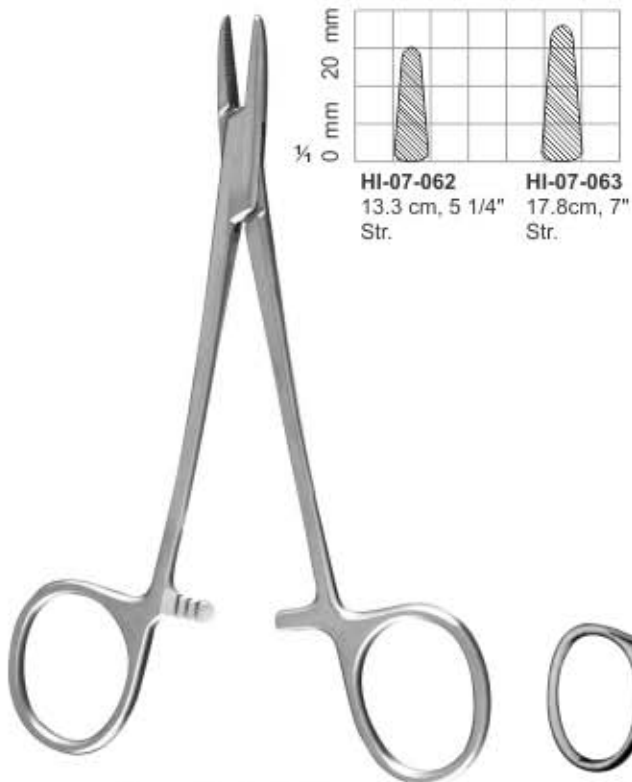

HI-07-062
 13.3 cm, 5 1/4"
 Str.

HI-07-063
 17.8cm, 7"
 Str.

Brown Needle Holders

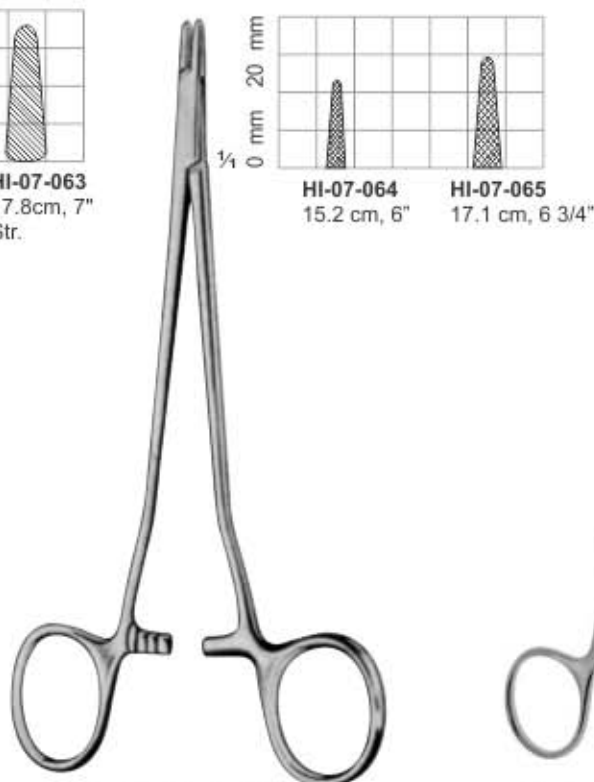

HI-07-064
 15.2 cm, 6"

HI-07-065
 17.1 cm, 6 3/4"

**Senning Needle Holders
 (Schwed. Model)**

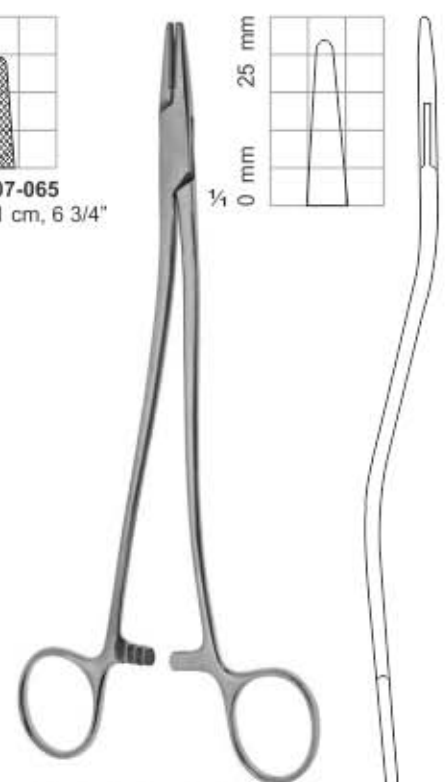

Wertheim Needle Holders
HI-07-066 20 cm, 8"
HI-07-067 24 cm, 9 1/2"

NEEDLE HOLDERS

Nadelhalter | Porta-agujas
 Prote-agulles | Porta aghi

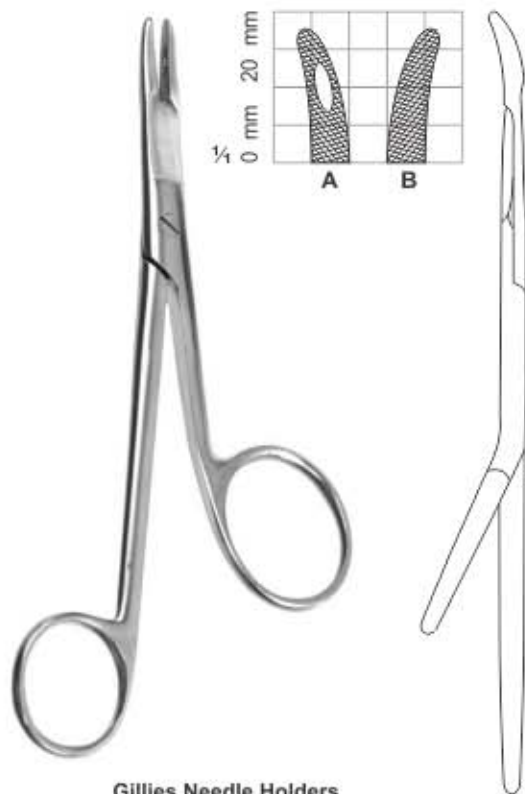

Gillies Needle Holders
 HI-07-068
 16 cm, 6 1/4"

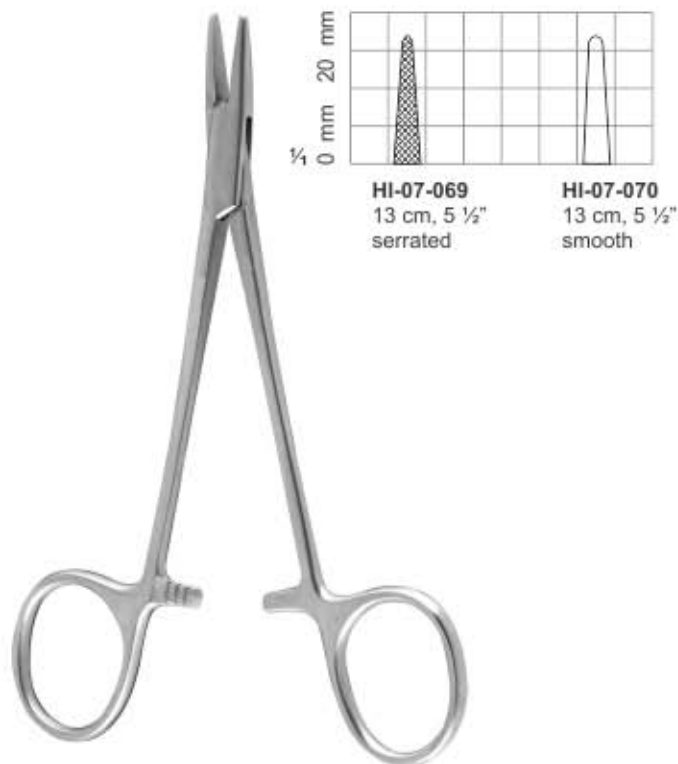

HI-07-069
 13 cm, 5 1/2"
 serrated

HI-07-070
 13 cm, 5 1/2"
 smooth

Halsey Needle Holders

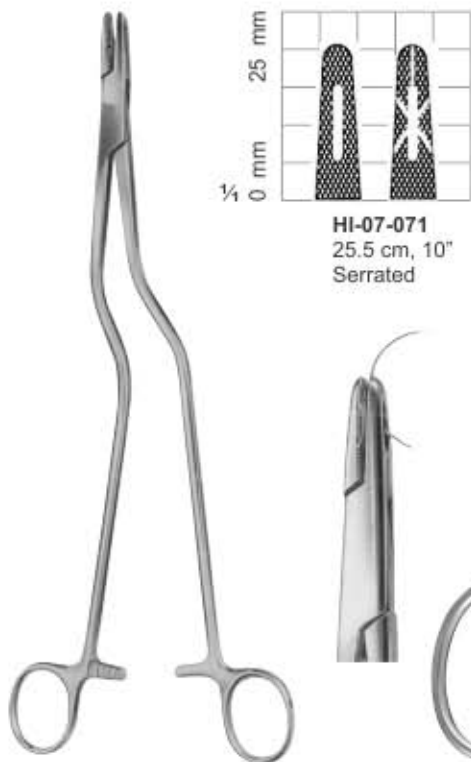

HI-07-071
 25.5 cm, 10"
 Serrated

**Masson-Luethy
 Needle Holders**

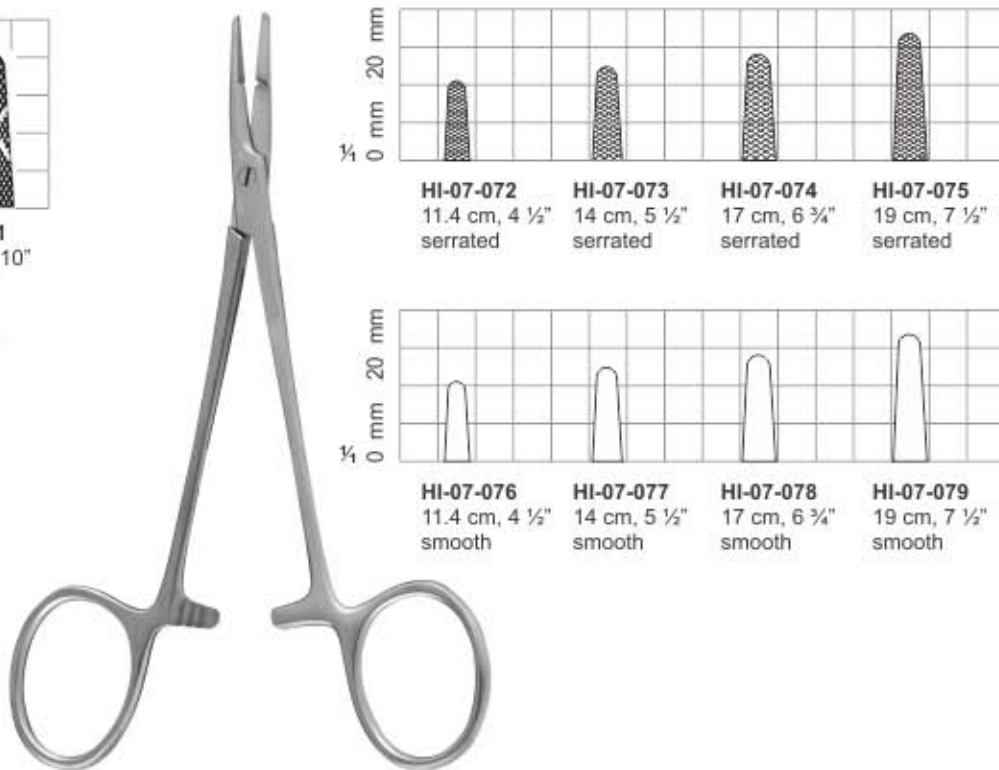

HI-07-072
 11.4 cm, 4 1/2"
 serrated

HI-07-073
 14 cm, 5 1/2"
 serrated

HI-07-074
 17 cm, 6 3/4"
 serrated

HI-07-075
 19 cm, 7 1/2"
 serrated

HI-07-076
 11.4 cm, 4 1/2"
 smooth

HI-07-077
 14 cm, 5 1/2"
 smooth

HI-07-078
 17 cm, 6 3/4"
 smooth

HI-07-079
 19 cm, 7 1/2"
 smooth

Olsen-Hegar Needle Holders

NEEDLE HOLDERS

Nadelhalter | Porta-agujas
 Prote-aiguilles | Porta aghi

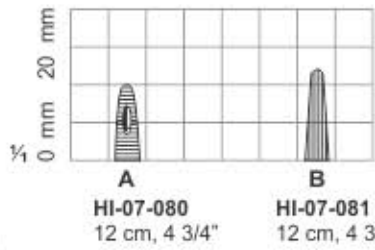
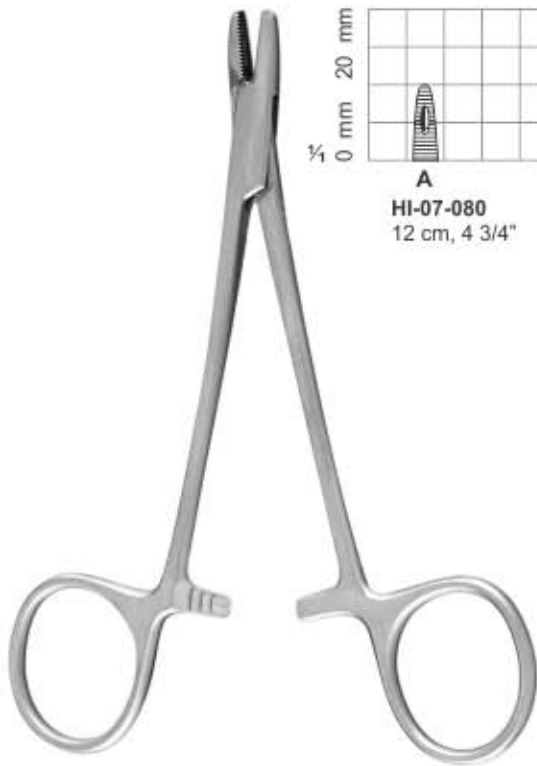

Derf Needle Holders

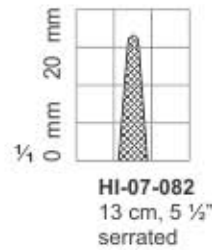

Kilner Needle Holders

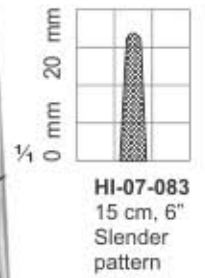
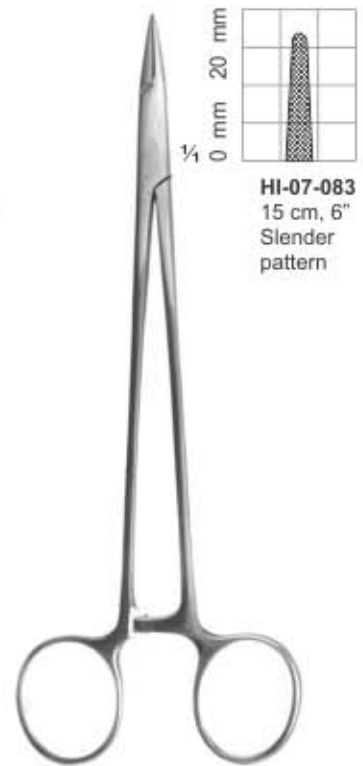

Crile-Murray
 Needle Holders

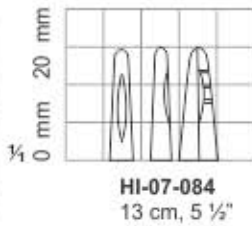
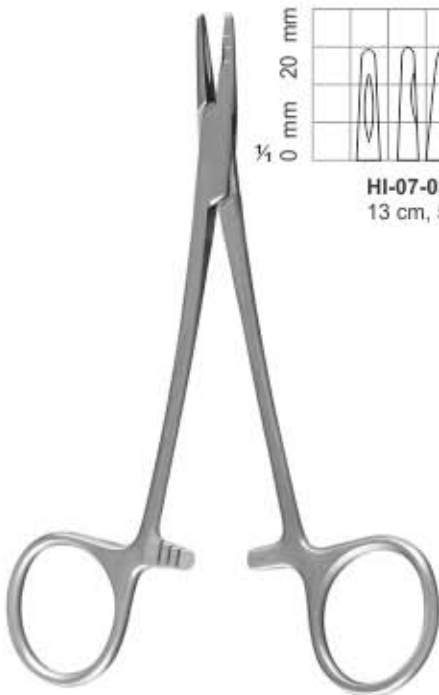

Neivert Needle Holders

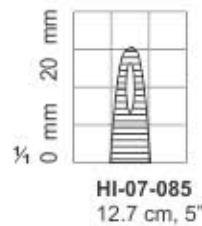

Collier Needle Holders

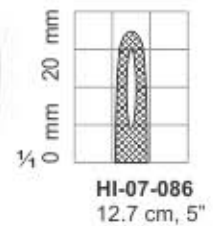

Doyen Needle Holders

NEEDLE HOLDERS

Nadelhalter | Porta-agujas
 Prote-aiguilles | Porta aghi

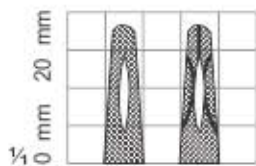

HI-07-087
 18.5 cm, 7 1/4"
 One grooved and fenestrated jaw

Metzenbaum Needle Holders

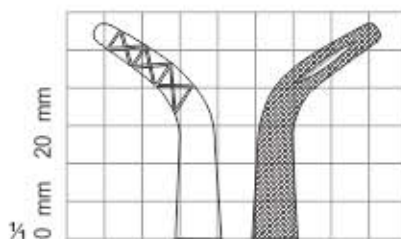

HI-07-088
 27 cm, 10 3/4"

Johnson Needle Holders

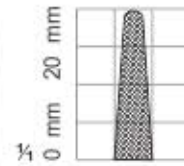

HI-07-089
 26.5 cm, 10 1/2"
 Serrated-Solid

Wangensteen
 Needle Holders

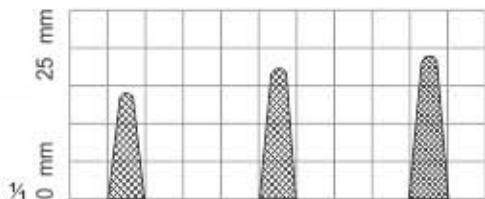

HI-07-090 **HI-07-091** **HI-07-092**
 14 cm, 5 1/2" 17 cm, 6 3/4" 20 cm, 8"

Mathieu Needle Holders

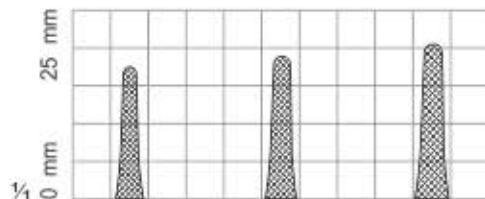

HI-07-093 **HI-07-094** **HI-07-095**
 14 cm, 5 1/2" 16.5 cm, 6 1/2" 20 cm, 8"
 Narrow Jaws Narrow Jaws Narrow Jaws

Mathieu Needle Holders

NEEDLE HOLDERS

Nadelhalter | Porta-agujas
 Prote-aiguilles | Porta aghi

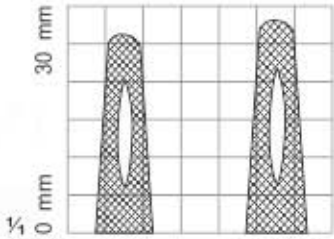

HI-07-096
17.8 cm, 8"
HI-07-097
23 cm, 9"

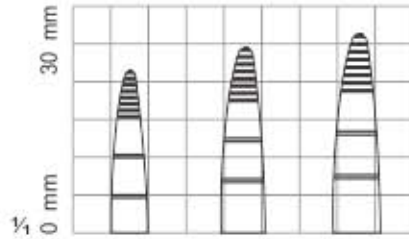

HI-07-098
15 cm, 6"
lined with copper.
HI-07-099
17.8 cm, 7"
lined with copper.
HI-07-100
20 cm, 8"
lined with copper.

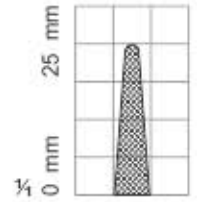

HI-07-101
18.5 cm, 7 1/4"

Mayo Rochester Needle Holders
button release, screw joint.

Macphail Needle Holders

Toennis Needle Holders

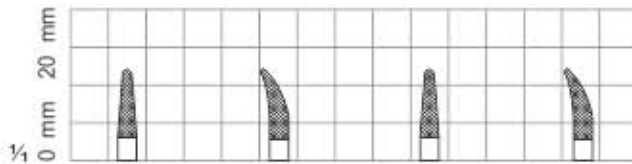

HI-07-102
12.7 cm, 5"
with lock straight
HI-07-103
12.7 cm, 5"
with lock curved
HI-07-104
12.7 cm, 5"
without lock straight
HI-07-105
12.7 cm, 5"
without lock curved

Castroviejo Needle Holders

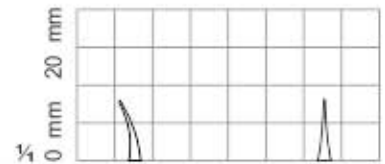

HI-07-106
14 cm, 5 1/2"
Curved, Smooth
with lock curved
HI-07-107
14 cm, 5 1/2"
Straight, Smooth
with lock curved

Barraquer Needle Holders

NEEDLE HOLDERS

Nadelhalter | Porta-agujas
 Prote-aiguilles | Porta aghi

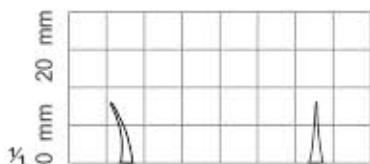

HI-07-108
 14 cm, 5 1/2"
 Curved, Smooth
 without lock
 curved

HI-07-109
 14 cm, 5 1/2"
 Straight, Smooth
 without lock
 curved

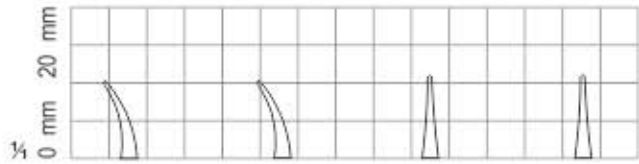

HI-07-110
 14 cm, 5 1/2"
 Curved
 Smooth
 with lock

HI-07-111
 14 cm, 5 1/2"
 Curved
 Smooth
 without lock

HI-07-112
 14 cm, 5 1/2"
 Straight
 Smooth
 with lock

HI-07-113
 14 cm, 5 1/2"
 Straight
 Smooth
 without lock

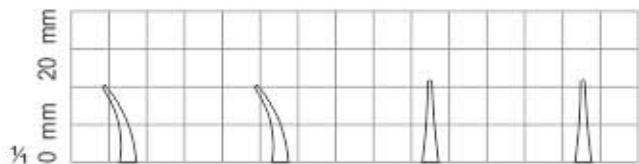

HI-07-114
 17.8 cm, 7"
 Curved
 Smooth
 with lock

HI-07-115
 17.8 cm, 7"
 Curved
 Smooth
 without lock

HI-07-116
 17.8 cm, 7"
 Straight
 Smooth
 with lock

HI-07-117
 17.8 cm, 7"
 Straight
 Smooth
 without lock

Barraquer Needle Holders

Castroviejo Needle Holders

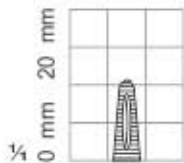

HI-07-120
 12 cm, 5"

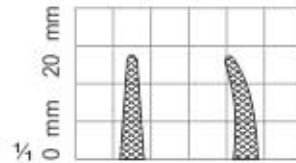

HI-07-121 **HI-07-122**
 16 cm, 6 1/4" Str. 16 cm, 6 1/4" Cvd.

**Castroviejo Olsen Heager /
 Needle Holders / Scissors**
HI-07-118 14.5 cm, 5 3/4"
HI-07-119 15.0 cm, 6"

Boynton Needle Holders

Arruga Needle Holders

NEEDLE HOLDERS

Nadelhalter | Porta-agujas
 Prote-aiguilles | Porta aghi

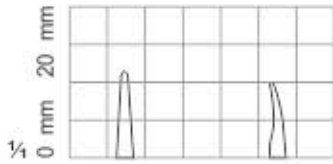

HI-07-123
 19.5 cm, 7 3/4"
 Smooth Str.

HI-07-124
 23 cm, 9"
 Smooth Cvd.

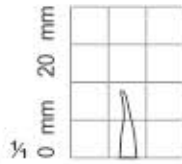

HI-07-125
 16 cm, 6 1/4"
 Smooth Cvd.

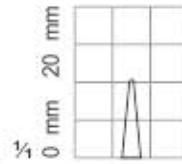

HI-07-126
 12 cm, 5"
 Smooth Str
 with lock

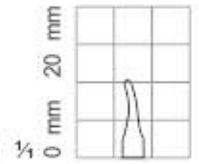

HI-07-127
 12 cm, 5"
 Smooth Cvd
 with lock

Micro Needle Holders

Micro Needle Holders

Castroviejo Needle Holders

Castroviejo Needle Holders

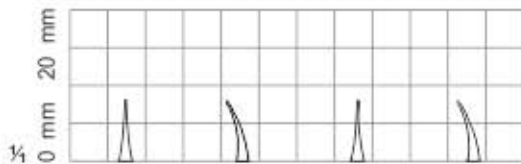

HI-07-128
 10.5 cm, 4"
 Smooth Str.

HI-07-129
 10.5 cm, 4"
 Smooth Cvd.

HI-07-130
 11.5 cm, 4 1/2"
 Smooth Str.

HI-07-131
 11.5 cm, 4 1/2"
 Smooth Cvd.

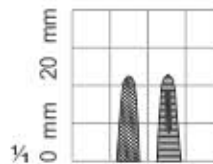

HI-07-132
 13.5 cm, 5 1/4"
 Serrated

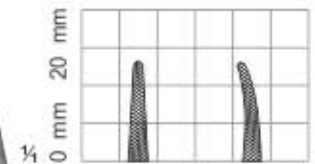

HI-07-133
 13.5 cm,
 5 1/4"
 Serrated Str.

HI-07-134
 13.5 cm,
 5 1/4"
 Serrated Cvd.

Barraquer-TROUTMAN Needle Holders

Kalt Needle Holders

Arruga Needle Holders

NEEDLE HOLDERS T.C

Nadelhalter | Porta-agujas
 Prote-aiguilles | Porta aghi

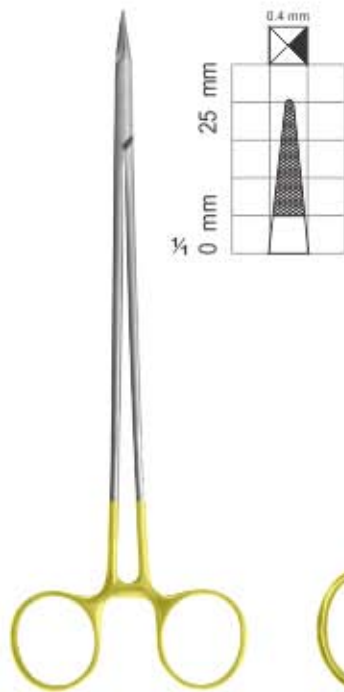

**MICROVASCULAR
 Needle Holders T.C.**
 HI-07-135 17.8 cm, 7"
 HI-07-136 20 cm, 8"
 HI-07-137 22 cm, 8 3/4"
 HI-07-138 25 cm, 10"



**Micro Ryder Needle
 Holders T.C.**

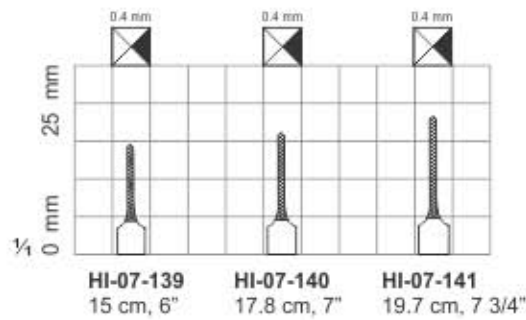

Carroll Needle Holders T.C.



**Crile-Wood Needle
 Holders T.C.**

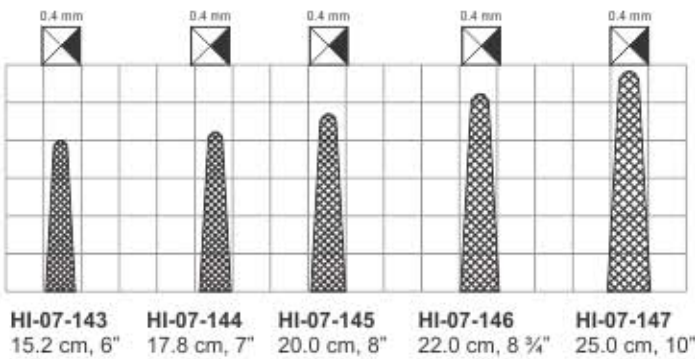

**New Orleans Needle
 Holders T.C.**

NEEDLE HOLDERS T.C

Nadelhalter | Porta-agujas
 Prote-aiguilles | Porta aghi

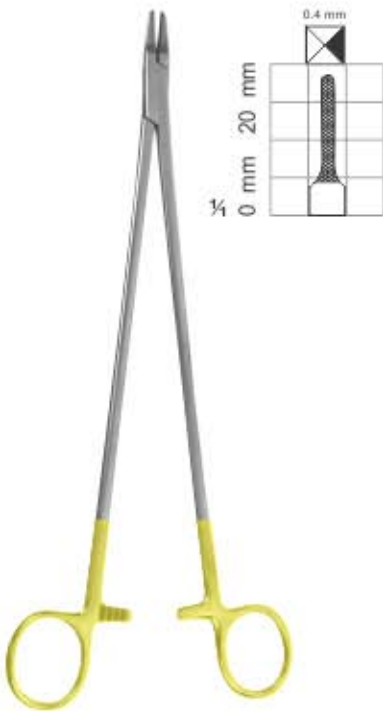

Intracardiac Needle Holders T.C.
 HI-07-150 18 cm, 7"
 HI-07-151 20 cm, 8"
 HI-07-152 22 cm, 8 3/4"
 HI-07-153 25 cm, 10"

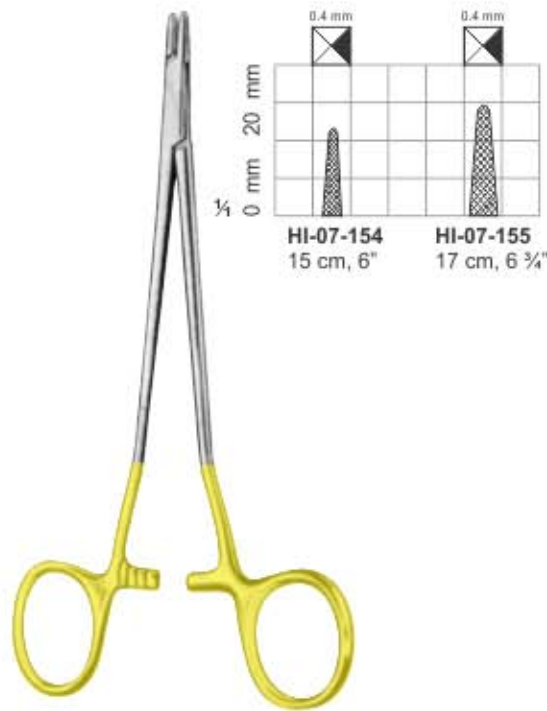

Senning Needle Holders T.C
 (Schwed. Model)

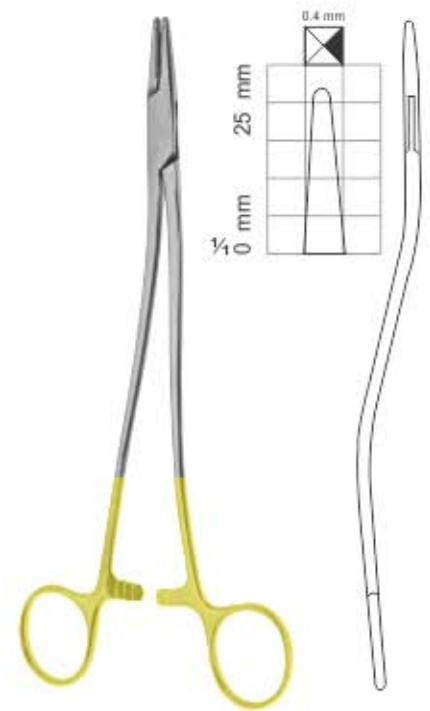

Wertheim Needle Holders T.C
 HI-07-156 20 cm, 8"
 HI-07-157 24 cm, 9 1/2"



Kilner Needle Holders T.C



Jacobson Needle Holders T.C

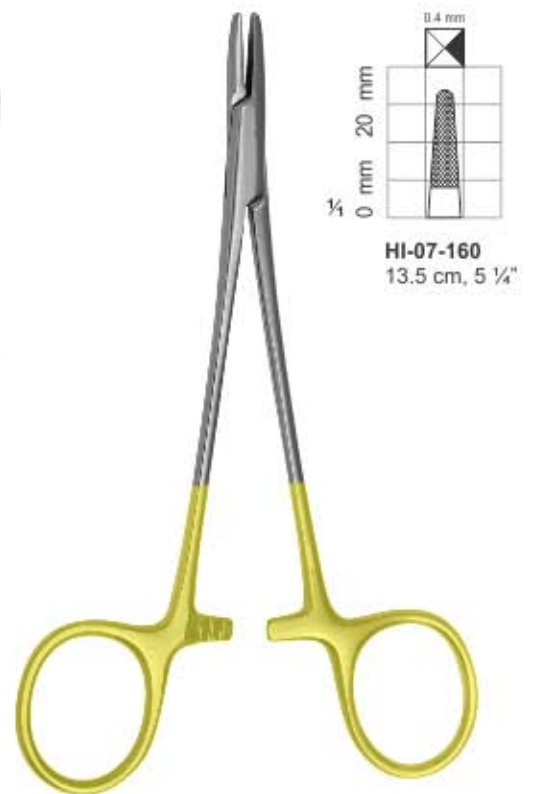

Baumgartner Needle Holders T.C

NEEDLE HOLDERS T.C

Nadelhalter | Porta-agujas
 Prote-aiguilles | Porta aghi

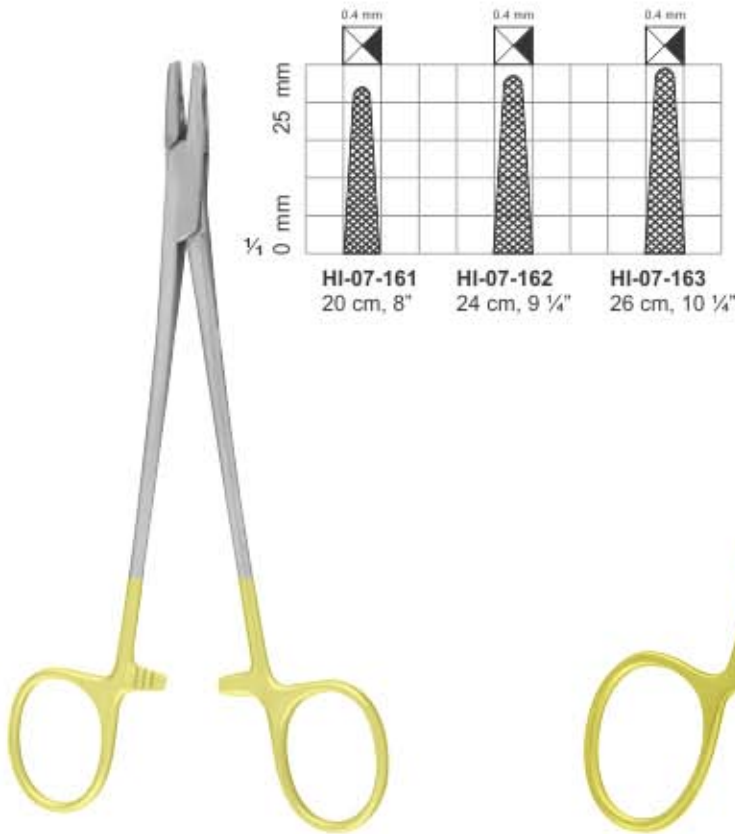

Bozemann Needle Holders T.C

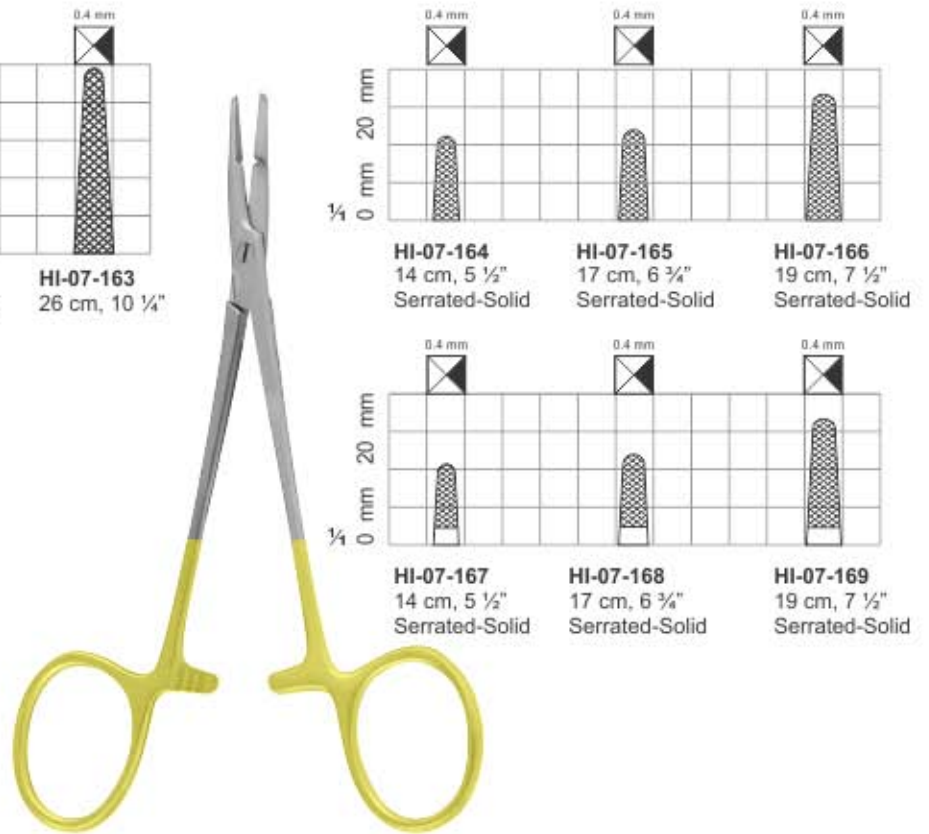

Olsen-Hegar Needle Holders T.C

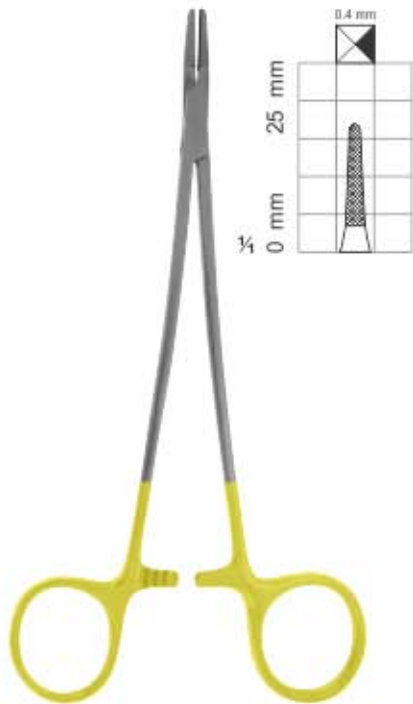

French-Eye Needle Holders T.C

- HI-07-170 16 cm, 6 1/4"
- HI-07-171 17.8 cm, 7"
- HI-07-172 20 cm, 8"
- HI-07-173 22 cm, 8 3/4"
- HI-07-174 25 cm, 10"

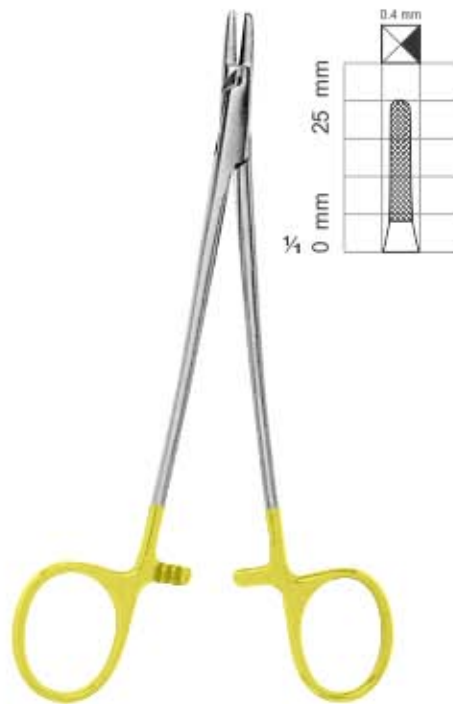

French-Eye Needle Holders T.C

- HI-07-175 15.2 cm, 6"
- HI-07-176 17.8 cm, 7"
- HI-07-177 20.3 cm, 8"
- HI-07-178 25.4 cm, 10"

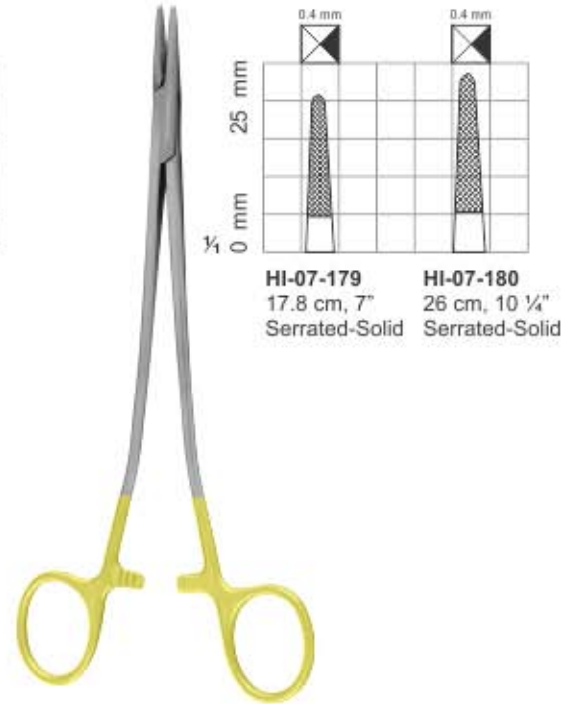

Sarot Needle Holders T.C

- HI-07-179 17.8 cm, 7" Serrated-Solid
- HI-07-180 26 cm, 10 1/4" Serrated-Solid

NEEDLE HOLDERS T.C

Nadelhalter | Porta-agujas
 Prote-aiguilles | Porta aghi

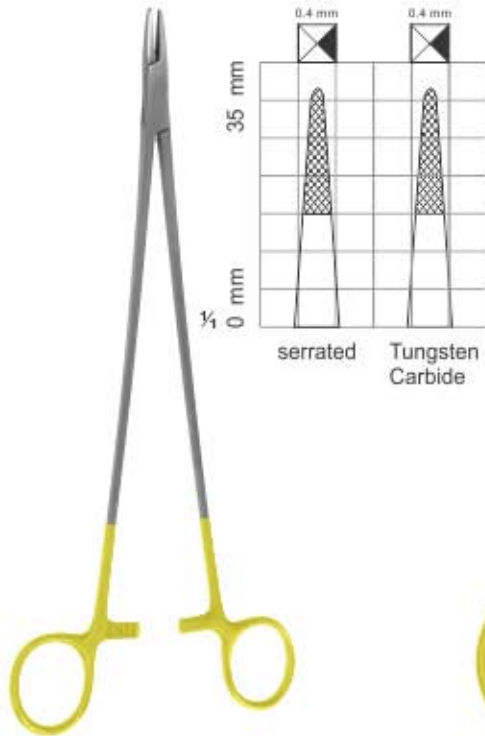

Wangenstein Needle Holders T.C
HI-07-181
 27.3 cm, 10 3/4"

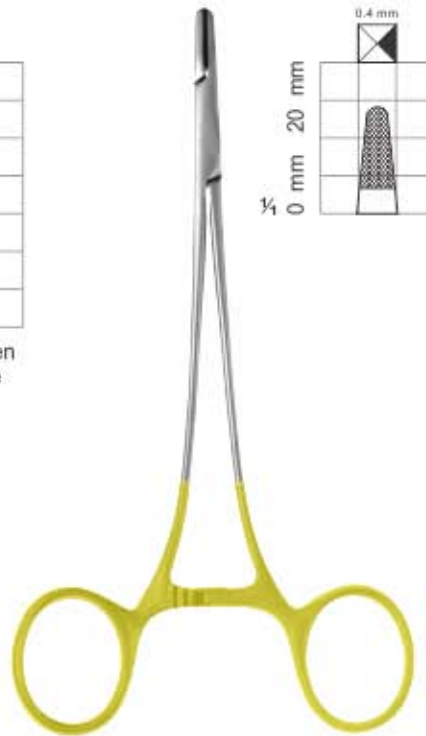

Finochietto Needle Holders T.C
HI-07-182 13 cm, 5 1/4"
HI-07-183 16 cm, 6 1/4"
HI-07-184 19 cm, 7 1/2"
HI-07-185 21 cm, 8 1/4"

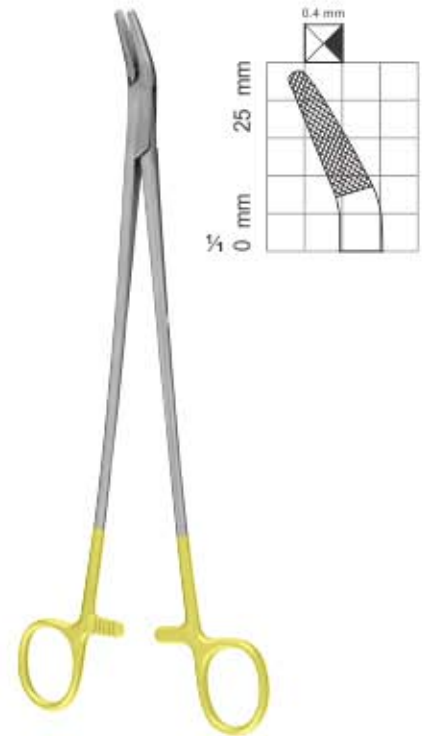

Finochietto Needle Holders T.C
HI-07-186 13 cm, 5 1/4"
HI-07-187 16 cm, 6 1/4"
HI-07-188 19 cm, 7 1/2"

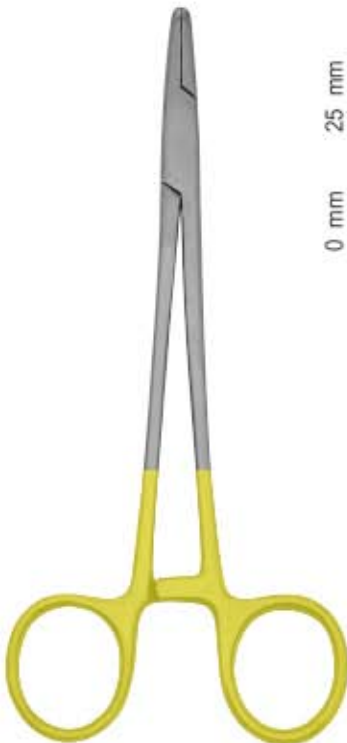

Mayo-Hegar Needle Holders T.C
 Also Available Right Handle

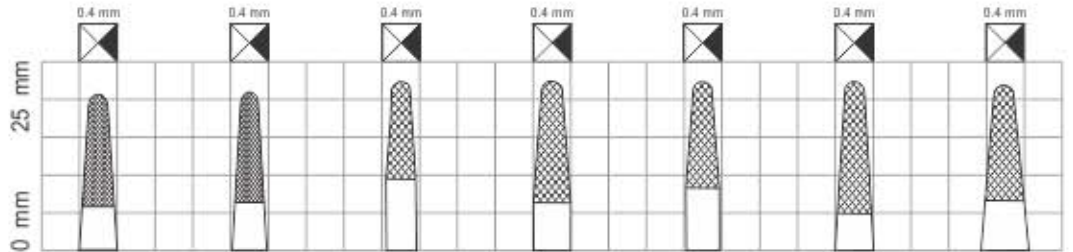

HI-07-189 16 cm, 6 1/4" Left handed.	HI-07-191 20 cm, 8" Left handed.	HI-07-193 15.2 cm, 6" Left handed.	HI-07-195 17.8 cm, 7" Left handed.	HI-07-197 20.3 cm, 8" Left handed.	HI-07-199 23 cm, 9" Left handed.	HI-07-201 25 cm, 10" Left handed.
HI-07-190 17.8 cm, 7"	HI-07-192 20 cm, 8"	HI-07-194 15.2 cm, 6"	HI-07-196 17.8 cm, 7"	HI-07-198 20.3 cm, 8"	HI-07-200 23 cm, 9"	HI-07-202 25 cm, 10"

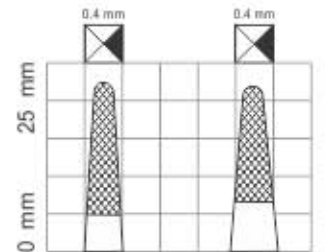

HI-07-203 27.94 cm, 11"	HI-07-205 29.8 cm, 12"
HI-07-204 27.94 cm, 11" Left handed.	HI-07-206 29.8 cm, 12" Left handed.



HI-07-207
 20.3 cm, 8"
 Curved

Finochietto Needle Holders T.C

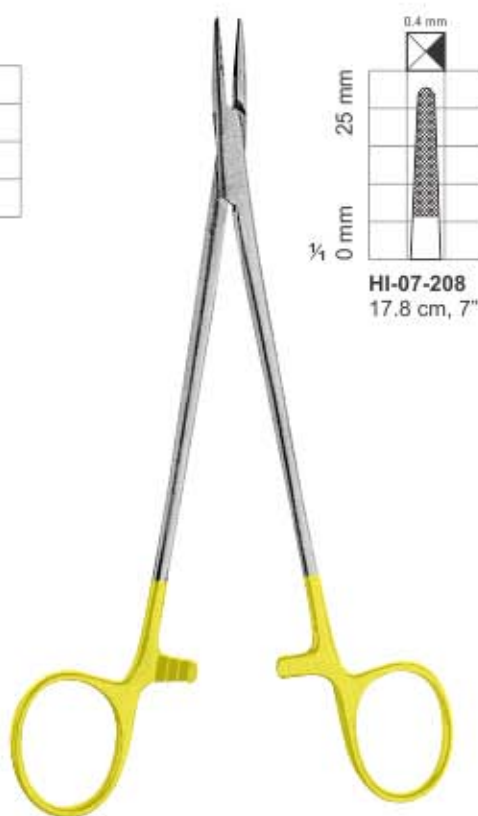

HI-07-208
 17.8 cm, 7"

Rochester Needle Holders T.C



HI-07-209
 16 cm, 6 1/4"

Gillies Needle Holders T.C

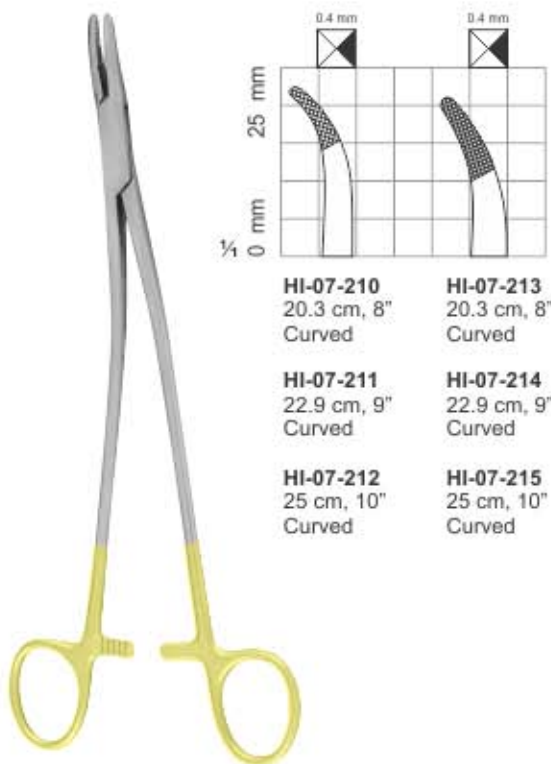

HI-07-210 20.3 cm, 8" Curved	HI-07-213 20.3 cm, 8" Curved
HI-07-211 22.9 cm, 9" Curved	HI-07-214 22.9 cm, 9" Curved
HI-07-212 25 cm, 10" Curved	HI-07-215 25 cm, 10" Curved

Stratte Needle Holders T.C

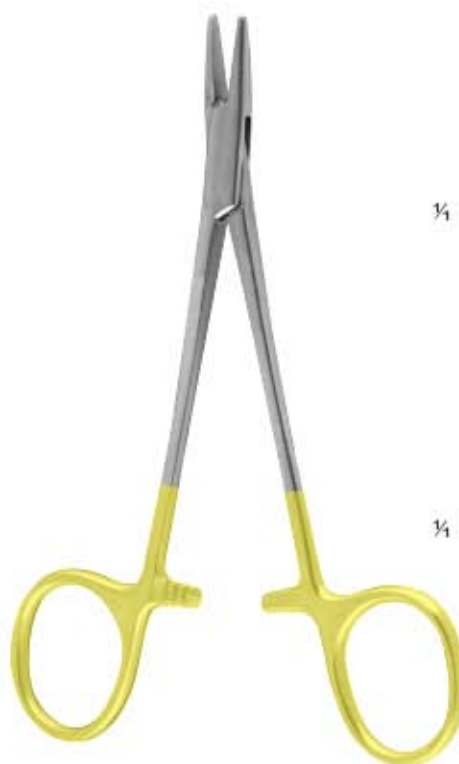

HI-07-216 12.5 cm, 5 1/4" Smooth	HI-07-217 12.5 cm, 5 1/4" Serrated-Solid
HI-07-218 12.5 cm, 5 1/4" Tungsten Carbide Smooth	HI-07-219 12.5 cm, 5 1/4" Tungsten Carbide Serrated-Solid

Halsey Needle Holders T.C

NEEDLE HOLDERS T.C

Nadelhalter | Porta-agujas
 Prote-aiguilles | Porta aghi



Ryder Needle Holders T.C
 Narrow jaws.

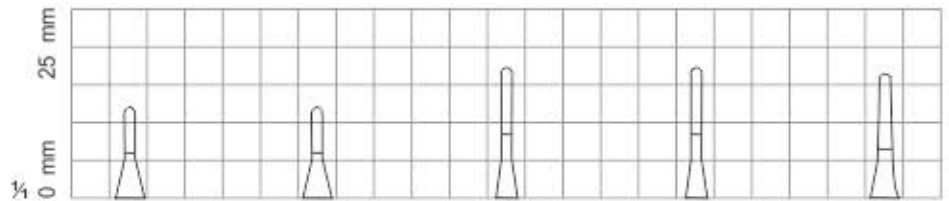

HI-07-220 Smooth inserts. 12.7 cm, 5 1/4"	HI-07-221 Smooth inserts. 15.2 cm, 6"	HI-07-222 Smooth inserts. 17.8 cm, 7"	HI-07-223 Smooth inserts. 20.3 cm, 8"	HI-07-224 Smooth inserts. 22.9 cm, 9"
--	--	--	--	--

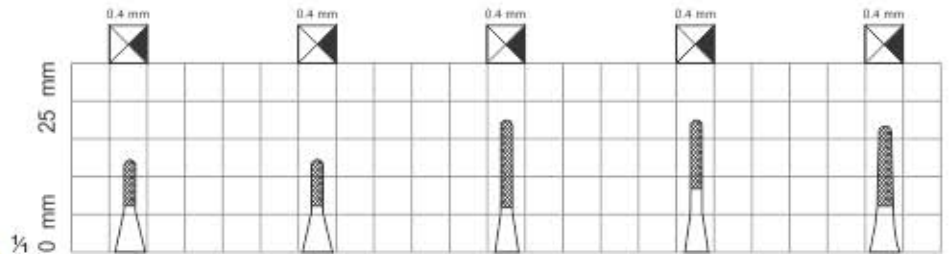

HI-07-225 12.7 cm, 5 1/4"	HI-07-226 15.2 cm, 6"	HI-07-227 17.8 cm, 7"	HI-07-228 20.3 cm, 8"	HI-07-229 22.9 cm, 9"
-------------------------------------	---------------------------------	---------------------------------	---------------------------------	---------------------------------

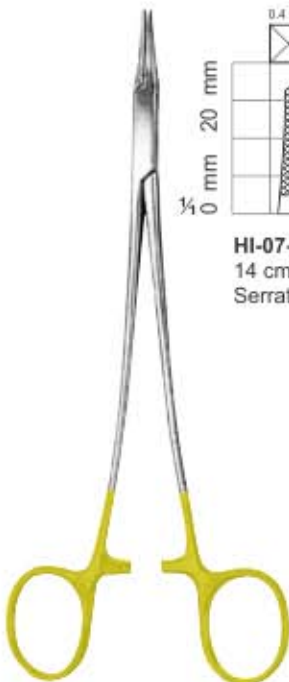

Eufrate Pasque T.C
 Needle Holders

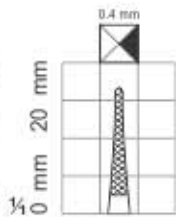

HI-07-230
 14 cm, 5 1/2"
 Serrated-Delicate

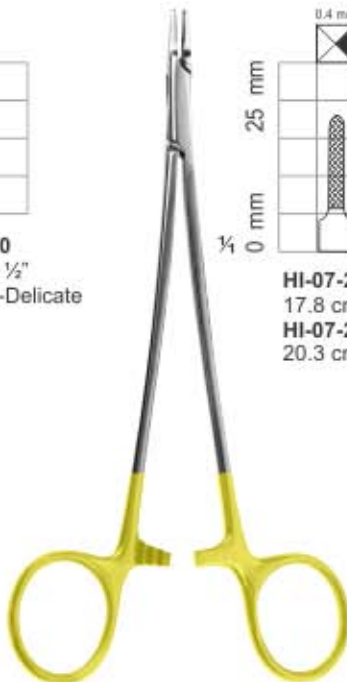

Cooley Intracardiac Needle Holders T.C
 Narrow Jaw.

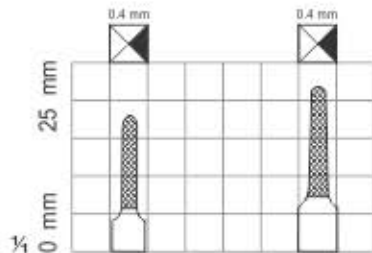

HI-07-231 17.8 cm, 7"	HI-07-233 22.9 cm, 9"
HI-07-232 20.3 cm, 8"	HI-07-234 26.3 cm, 10 1/2"

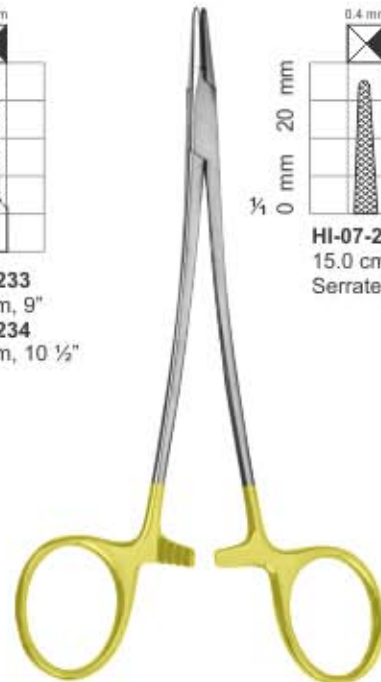

Baby Crile-Wood Needle Holders T.C

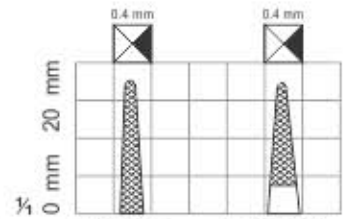

HI-07-235 15.0 cm, 6"	HI-07-236 15 cm, 6"
---------------------------------	-------------------------------

Serrated-Solid Serrated-Solid

NEEDLE HOLDERS T.C

Nadelhalter | Porta-agujas
 Prote-aiguilles | Porta aghi



HI-07-237
 11.5 cm, 4 1/2"
 Tungsten Carbide
 Serrated-Solid

HI-07-238
 13.5 cm, 5 1/4"

HI-07-239
 13 cm, 5"
 Tungsten
 Carbide
 Smooth

HI-07-240
 13 cm, 5"
 Tungsten
 Carbide
 Serrated-Solid

Derf Needle Holders T.C

Baumgartner Needle Holders T.C

Halsey Needle Holders T.C

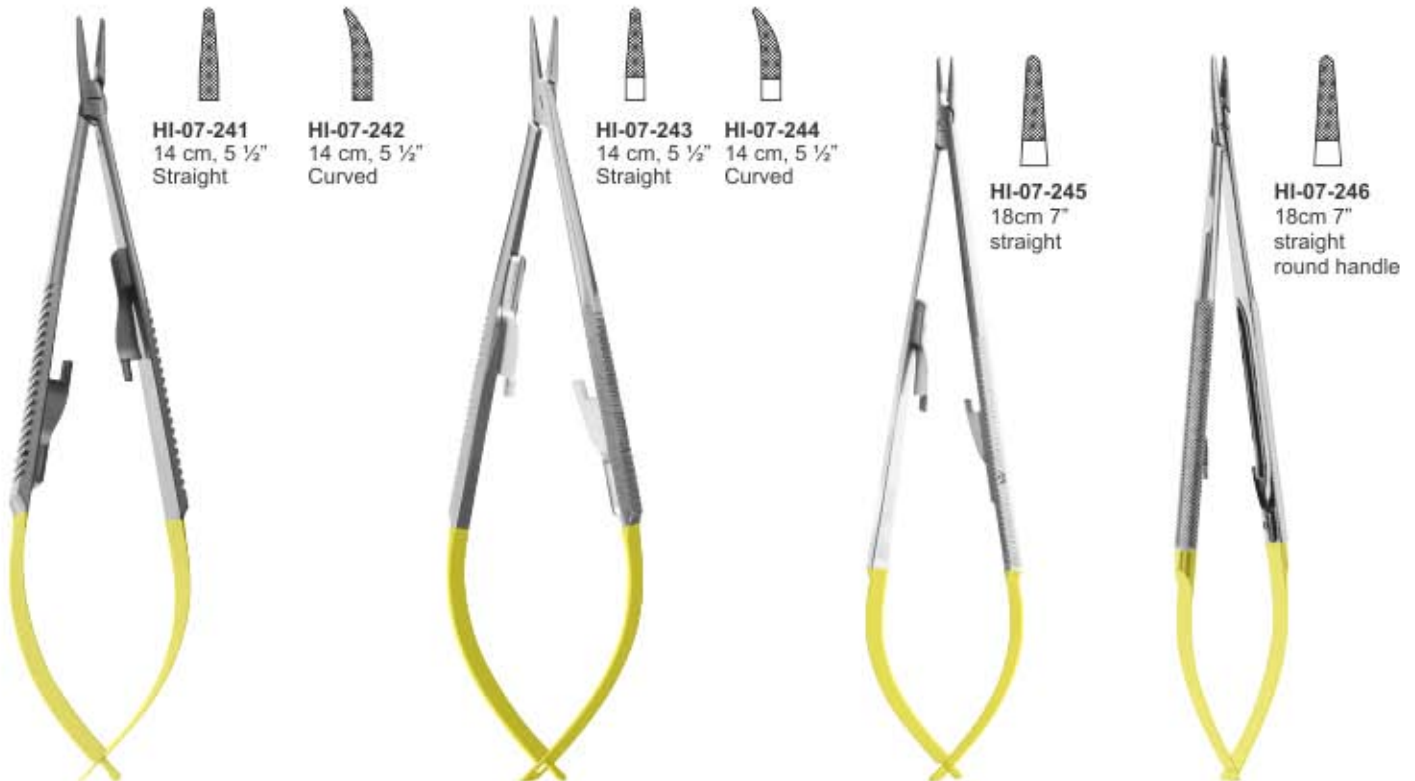

HI-07-241
 14 cm, 5 1/2"
 Straight

HI-07-242
 14 cm, 5 1/2"
 Curved

HI-07-243
 14 cm, 5 1/2"
 Straight

HI-07-244
 14 cm, 5 1/2"
 Curved

HI-07-245
 18cm 7"
 straight

HI-07-246
 18cm 7"
 straight
 round handle

Castroviejo Needle Holders T.C

Castroviejo Needle Holders T.C

Castroviejo
 Needle Holders
 T.C

Castroviejo Needle Holders T.C

NEEDLE HOLDERS T.C

Nadelhalter | Porta-agujas
 Prote-aiguilles | Porta aghi

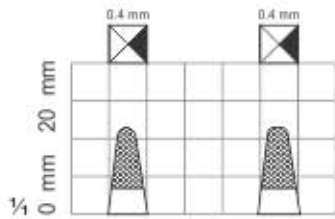

HI-07-247
 15.2 cm, 6"
 Delicate.

HI-07-248
 15.2 cm, 6"
HI-07-249
 17.8 cm, 7"
HI-07-250
 20 cm, 8"
 Heavy

Wire Twisters Needle Holders T.C

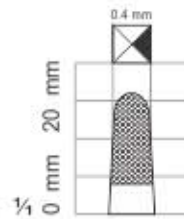
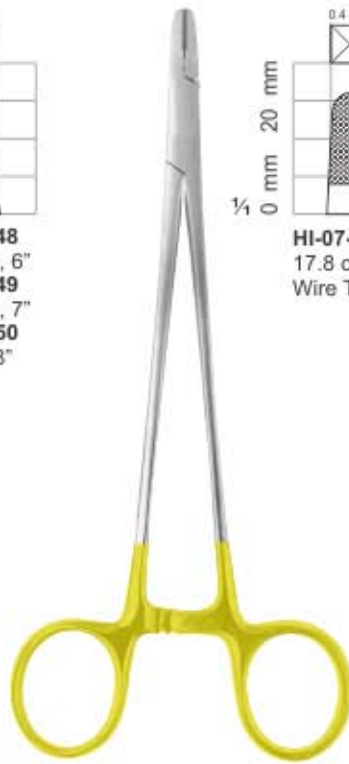

HI-07-251
 17.8 cm, 7"
 Wire Twister

Sternum Needle Holders T.C

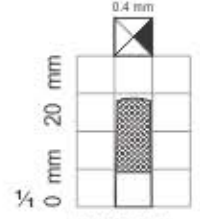
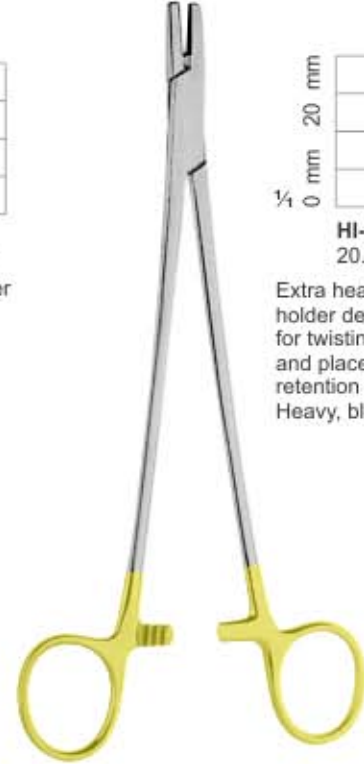

HI-07-252
 20.3 cm, 8"
 Extra heavy needle holder designed for twisting of wire and placement of retention suture. Heavy, blunt jaws.

Cooley-Baumgaften Wire Twister Needle Holders T.C

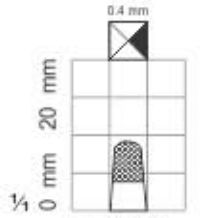

HI-07-253
 12.7 cm, 5 1/4"

Rubio Wire Twister Needle Holders T.C



Wire Tightening Needle Holders T.C
HI-07-254 18 cm, 7"

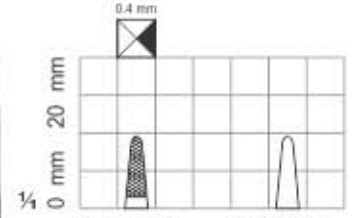
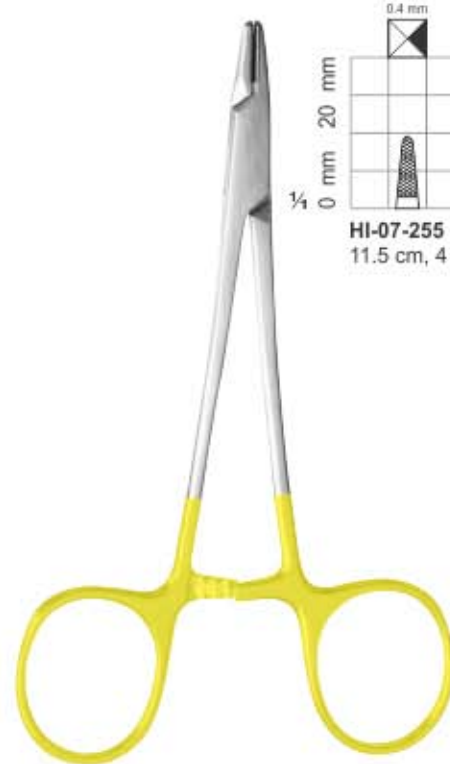

HI-07-255
 11.5 cm, 4 3/4"
HI-07-256
 11.5 cm, 4 3/4"
 Smooth

Micro Derf Needle Holders T.C



Crile-Wood Needle Holders T.C

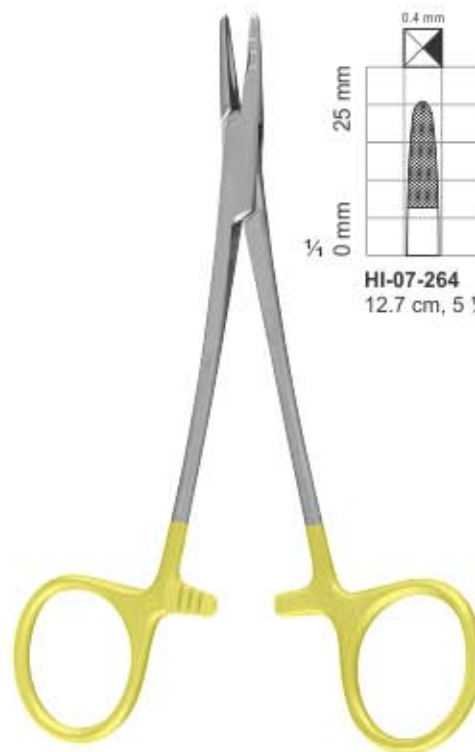
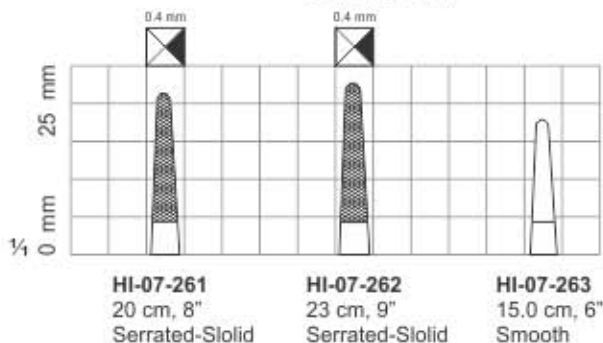
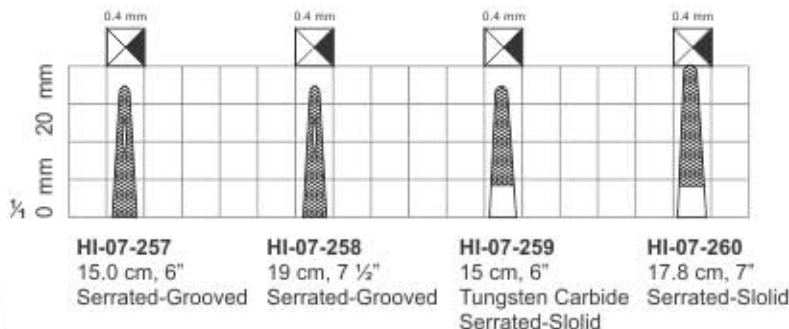

Neivert Needle Holders T.C

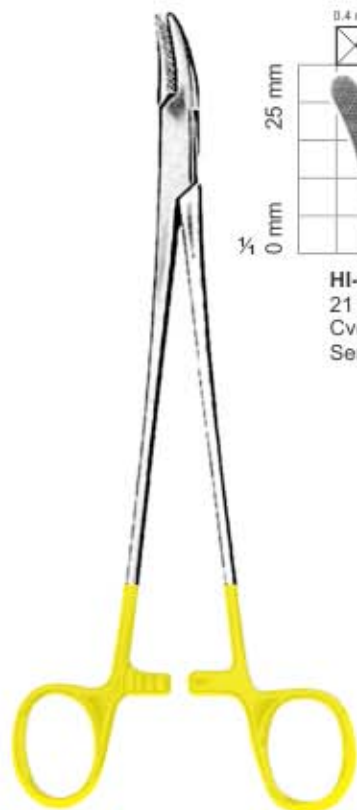
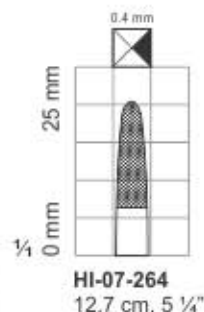

Heaney-Gyne Needle Holders T.C

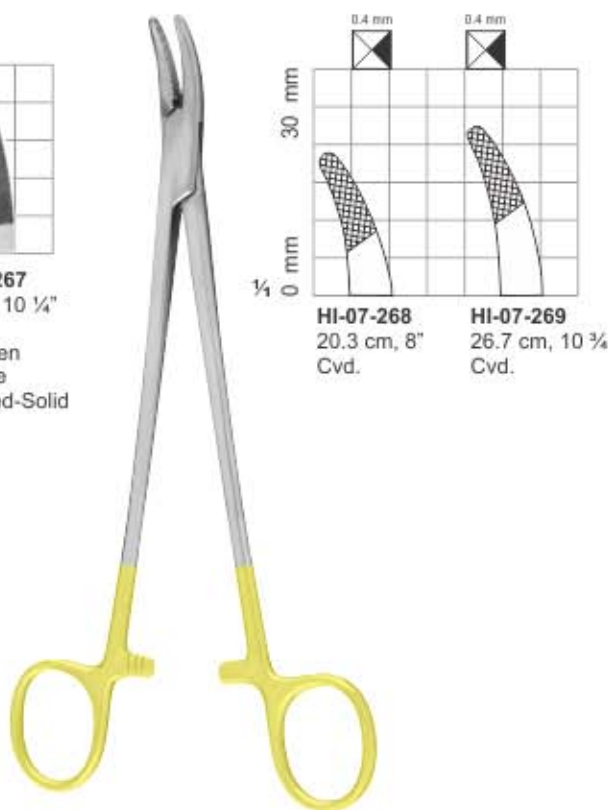
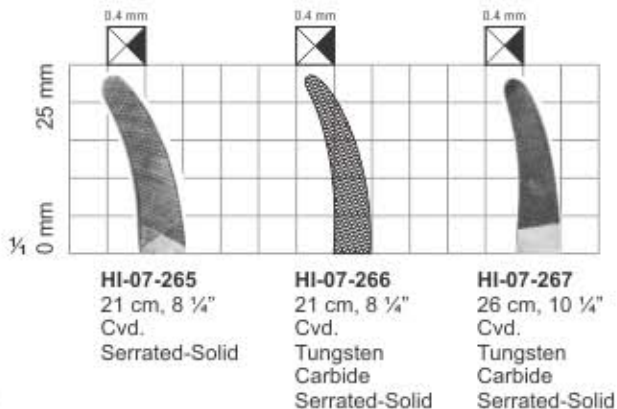

Heaney Needle Holders T.C

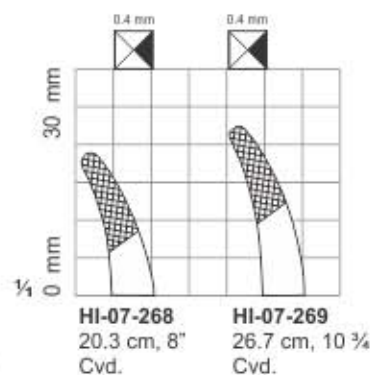

NEEDLE HOLDERS T.C

Nadelhalter | Porta-agujas
 Prote-aiguilles | Porta aghi



Webster Needle Holders T.C

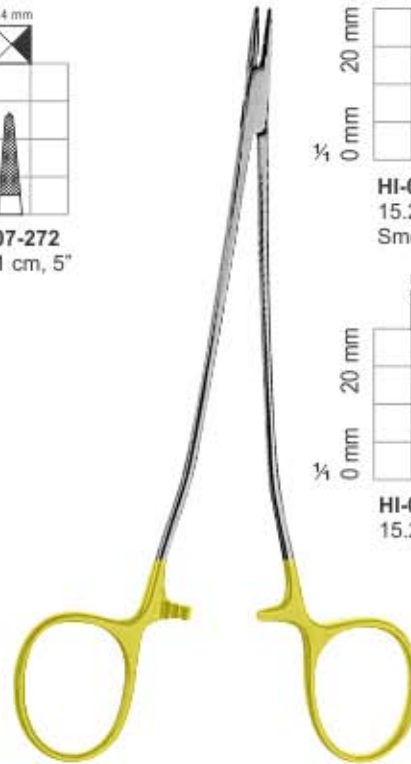
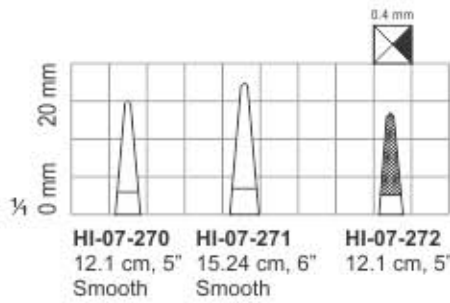

Cooley Microvascular Needle Holders T.C

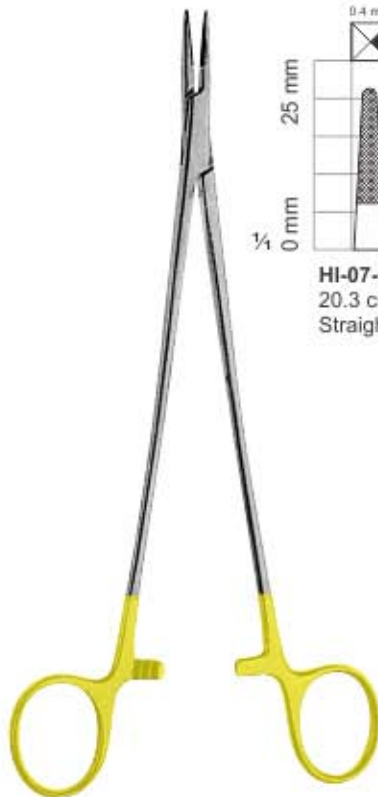
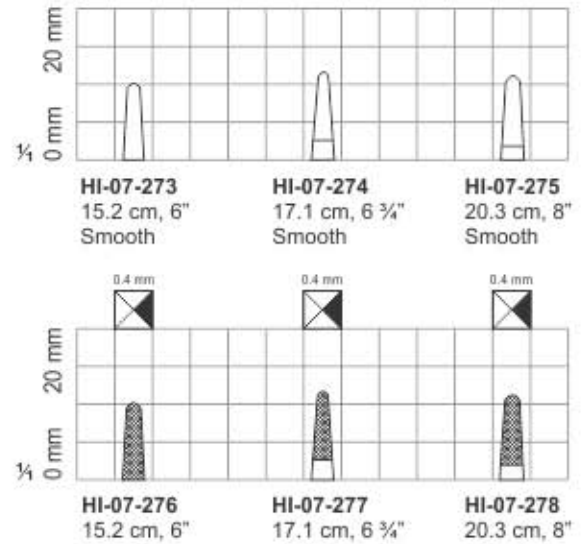

Julian Needle Holders T.C

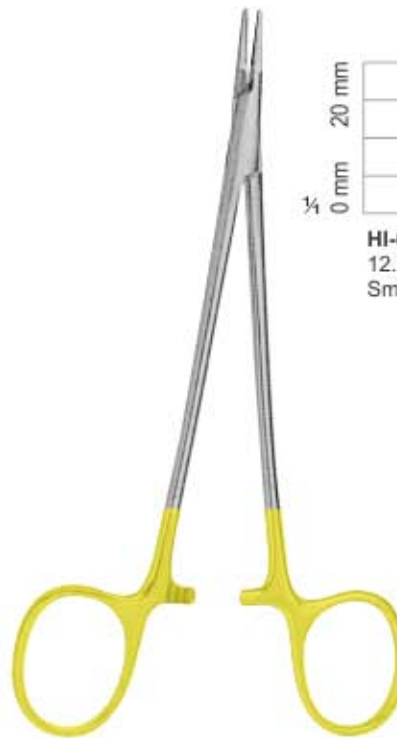
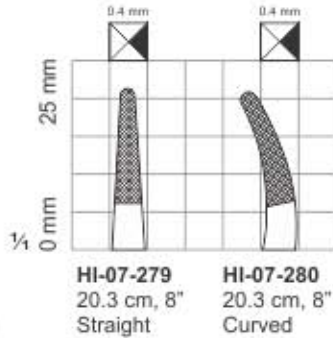

Micro Surgical Needle Holders T.C

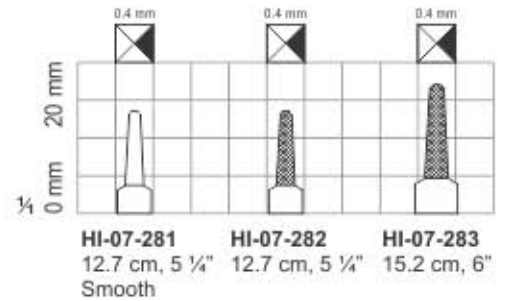

NEEDLE HOLDERS T.C

Nadelhalter | Porta-agujas
 Prote-aiguilles | Porta aghi

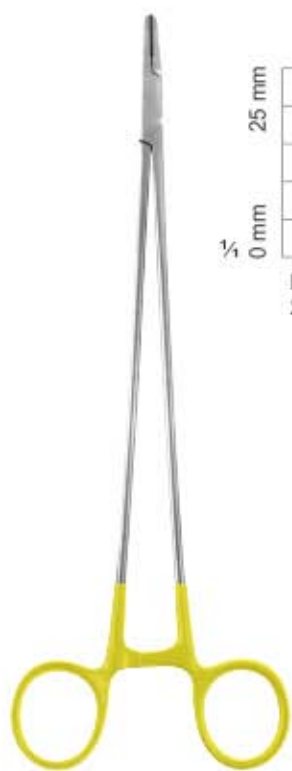

Masson Needle Holders T.C

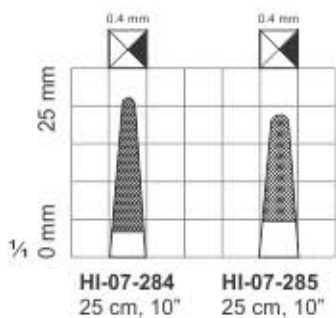

Webster Needle Holders T.C

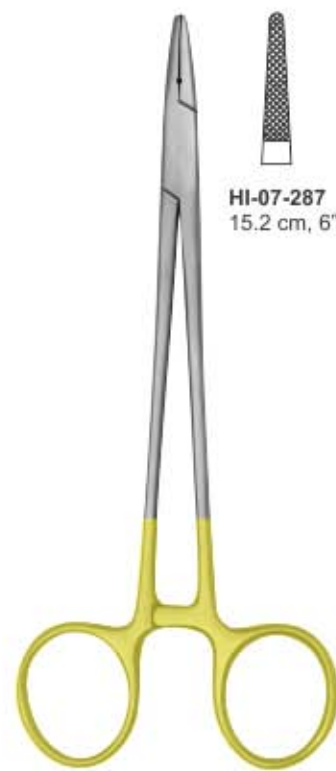

Crile-Wood Needle Holders T.C.



Mayo-Hegar Needle Holders T.C
 Also Available Right Handle

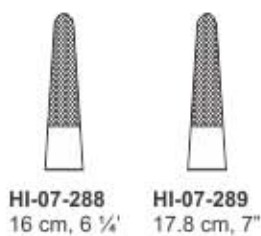

De Bakay Needle Holders T.C
HI-07-290
 17.8 cm, 7"
 Delicate



Olsen-Hegar Needle Holders T.C

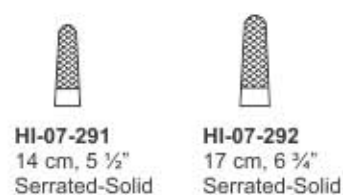

NEEDLE HOLDERS T.C

Nadelhalter | Porta-agujas
 Prote-aiguilles | Porta aghi



Arruga Needle Holders T.C
 HI-07-293 16 cm, 6 1/4" Str.
 HI-07-294 16 cm, 6 1/4" Cvd.



Castroviejo Needle Holders T.C

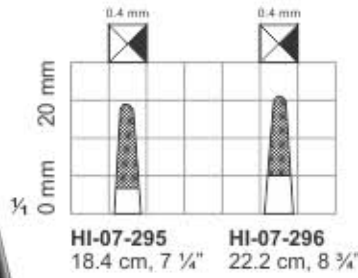

Castroviejo Needle Holders T.C

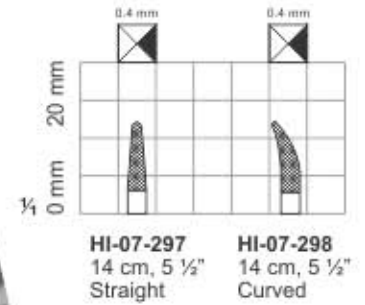

Jacobson Needle Holders T.C

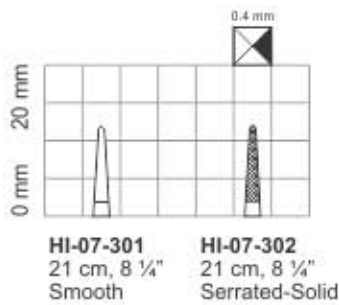
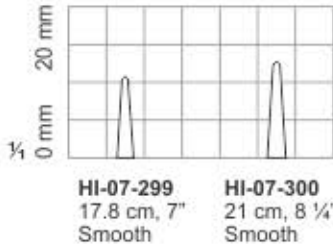

Castroviejo Needle Holders T.C

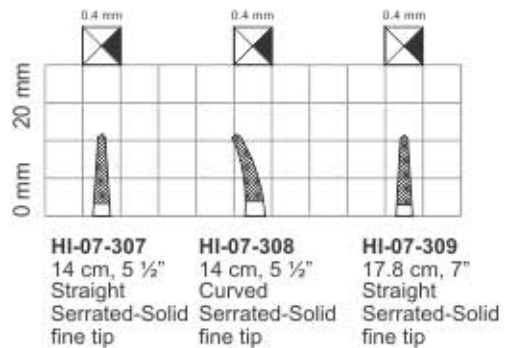
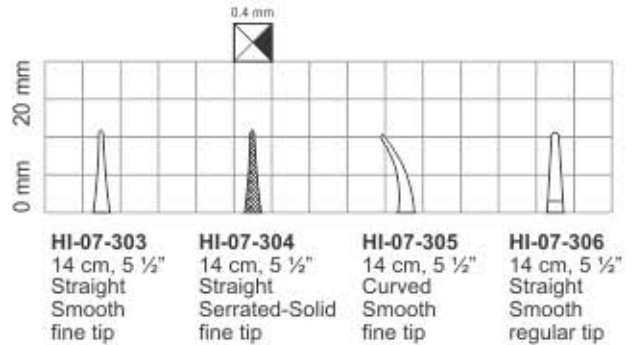

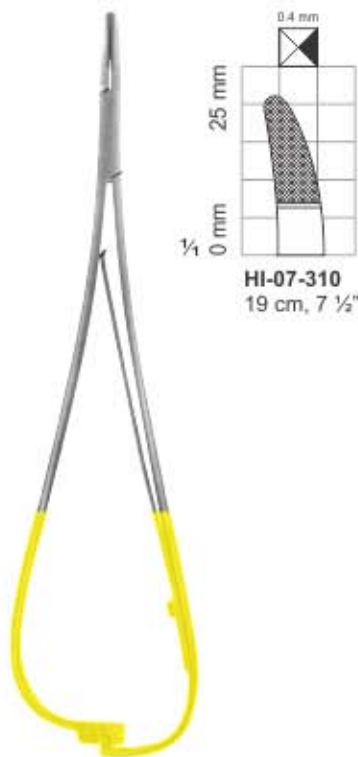

HI-07-310
 19 cm, 7 1/2"

Metzenbaum Needle Holders T.C

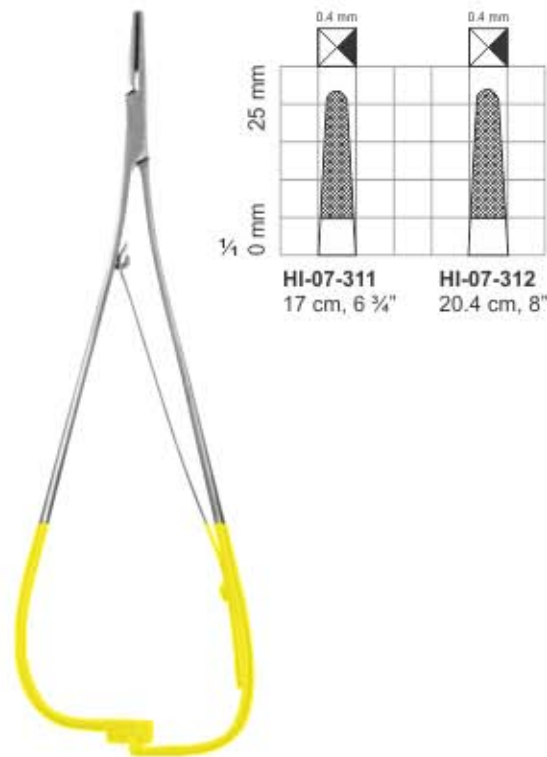

HI-07-311 17 cm, 6 3/4"
HI-07-312 20.4 cm, 8"

Mathieu-Stille Needle Holders T.C

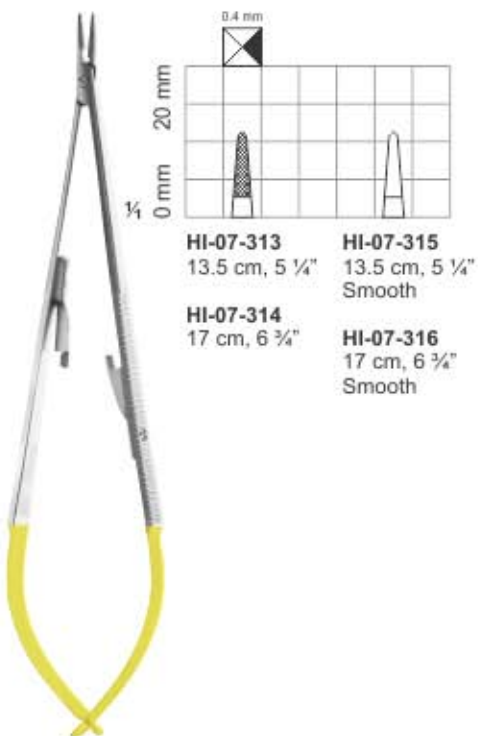

HI-07-313 13.5 cm, 5 1/4"
HI-07-314 17 cm, 6 3/4"
HI-07-315 13.5 cm, 5 1/4"
 Smooth
HI-07-316 17 cm, 6 3/4"
 Smooth

Castroviejo Needle Holders T.C



Jacobson Heavy Style Needle Holders T.C
HI-07-317 19.0 cm, 7 1/2"
HI-07-318 22.9 cm, 9"
HI-07-319 25.4 cm, 10"



Kalt Needle Holders T.C
HI-07-320 14 cm, 5 1/2" Str.

NEEDLE HOLDERS T.C

Nadelhalter | Porta-agujas
 Prote-aiguilles | Porta aghi



Mathieu-Ryder Needle Holders T.C

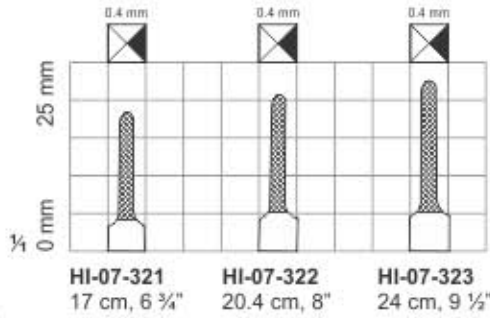

Mathieu-Ryder Vascular Needle Holders T.C

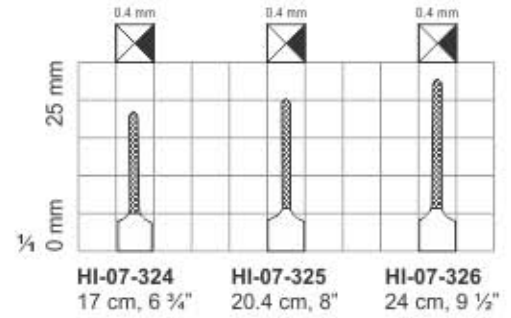

Corwin Needle Holders T.C

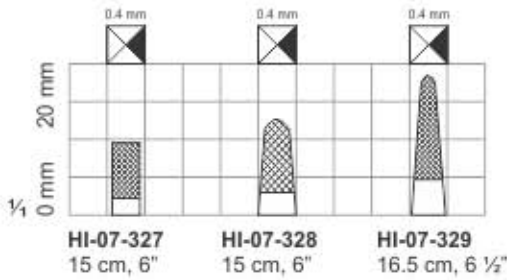

Lichtenberg Needle Holders T.C

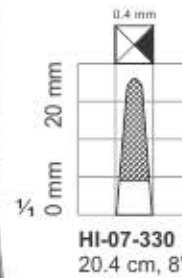

NEEDLE HOLDERS T.C

Nadelhalter | Porta-agujas
 Prote-aiguilles | Porta aghi

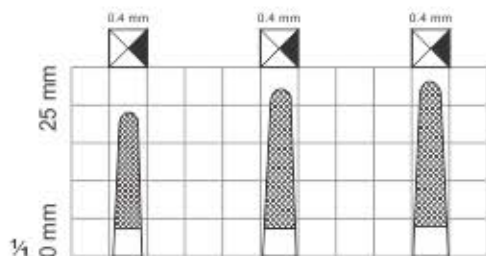

HI-07-331 16.0 cm, 6 1/4"
HI-07-332 17.8 cm, 7"
HI-07-333 20.4 cm, 8"

Langenbeck Needle Holders T.C

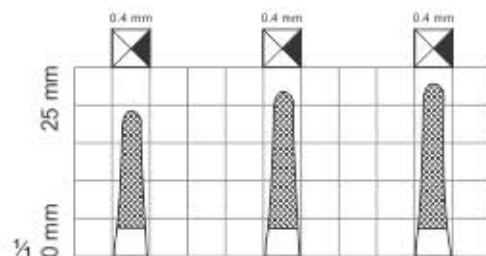

HI-07-334 17.8 cm, 7"
HI-07-335 20.4 cm, 8"
HI-07-336 23.0 cm, 9"

Langenbeck-Delicate Needle Holders T.C

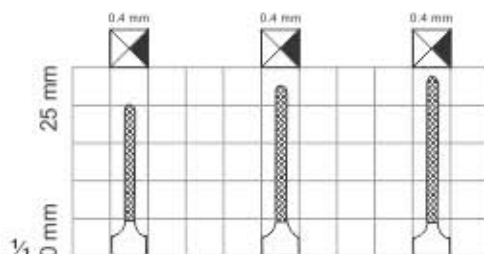

HI-07-337 17.8 cm, 7"
HI-07-338 20.4 cm, 8"
HI-07-339 23.0 cm, 9"

Langenbeck-Ryder Needle Holders T.C

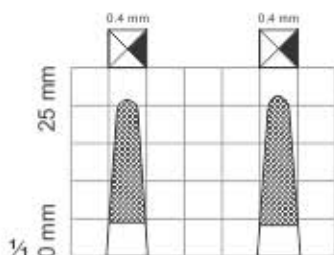

HI-07-340 20.4 cm, 8"
HI-07-341 23 cm, 9"

Zweifel Needle Holders T.C

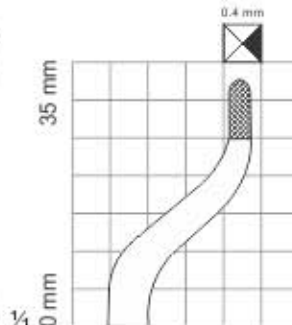

HI-07-342 18.5 cm, 7 1/4"

Eiselsberg-Matheiu Needle Holders T.C

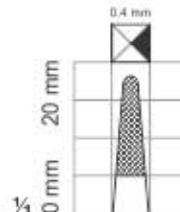

HI-07-343 20.4 cm, 8"

Luethy-Beck Needle Holders T.C

TITANIUM NEEDLE HOLDERS

Nadelhalter | Porta-agujas
 Prote-aiguilles | Porta aghi



HI-07-344
 TC-Coated jaws
 Straight
 11.5cm 4.5"



Derf Needle Holder
 Ring Handle



HI-07-345
 TC-Coated jaws
 Straight
 11.5cm 4.5"



Webster Needle Holder
 Ring Handle



HI-07-346
 TC-Coated jaws
 Straight
 13cm 5"



Halsey Needle Holders
 Ring Handle

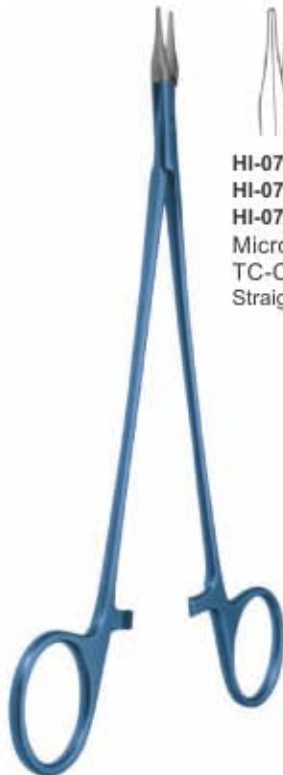

HI-07-347 15cm 6"
HI-07-348 17cm 6.75"
HI-07-349 19cm 7.5"
 Micro Jaws,
 TC-Coated jaws
 Straight



**Richards Micro
 Needle Holders**
 Ring Handle



HI-07-350 15cm 6"
HI-07-351 17cm 6"
HI-07-352 19cm 7.5"
 TC-Coated jaws
 Straight



Ryder Needle Holders
 Ring Handle



HI-07-353 17.8cm 7"
HI-07-354 20.4cm 8"
HI-07-355 22cm 8 3/4"
 Micro Jaws,
 TC-Coated jaws
 Straight



Ultra-Micro Needle Holders
 Ring Handle

TITANIUM NEEDLE HOLDERS

Nadelhalter | Porta-agujas
 Prote-aiguilles | Porta aghi



HI-07-356 17.8cm 7"
HI-07-357 20.4cm 8"
HI-07-358 22cm 8 3/4"
HI-07-359 25cm 10"
 TC-Coated jaws
 Straight

Intracardiac Needle Holder
 Ring Handle

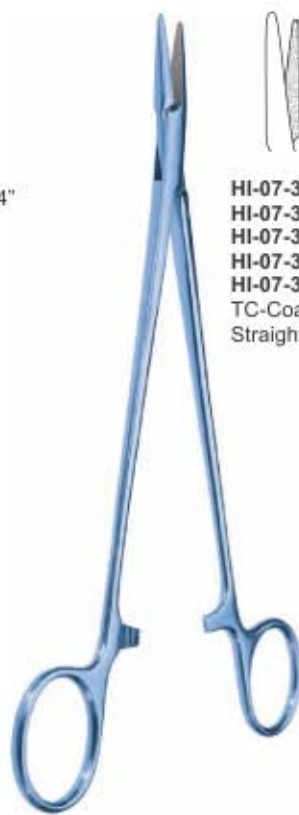

HI-07-360 16cm 6 1/4"
HI-07-361 17.8cm 7"
HI-07-362 20.4cm 8"
HI-07-363 22cm 8 3/4"
HI-07-364 25cm 10"
 TC-Coated jaws
 Straight

DeBakey Needle Holders
 Ring Handle



HI-07-365 17.8cm 7"
HI-07-366 20.4cm 8"
HI-07-367 22cm 8 3/4"
HI-07-368 25cm 10"
 Micro, jaws
 TC-Coated jaws
 w/Lock
 Straight

Microvascular Needle Holders
 Ring Handle



HI-07-369 16cm 6 1/4"
HI-07-370 17.8cm 7"
HI-07-371 20.4cm 8"
HI-07-372 22cm 8 3/4"
 2.8mm
 TC-Coated jaws
 Straight



HI-07-373 16cm 6 1/4"
HI-07-374 17.8cm 7"
HI-07-375 20.4cm 8"
HI-07-376 22cm 8 3/4"
 2.8mm
 TC-Inserted jaws
 Straight

Mayo-Hegar Needle Holders
 Ring Handle



Heavy, TC-Coated jaws w/Lock
HI-07-377 18.5cm 7.25"
HI-07-378 21cm 8.25"
HI-07-379 23cm 9.25"
HI-07-380 25cm 10"
HI-07-381 30cm 12"



Heavy, TC-Coated jaws w/Lock
HI-07-382 18.5cm 7.25"
HI-07-383 21cm 8.25"
HI-07-384 23cm 9.25"
HI-07-385 25cm 10"

Jacobson Heavy Needle Holders
 Round Handle, Straight / Curved Jaws



Straight, Micro, TC-Coated
HI-07-386 jaws
HI-07-387 jaws w/Lock



Curved, Micro,
 TC-Coated
HI-07-388 jaws
HI-07-389 jaws w/Lock

Round Bayonet Handle,
 Straight / Curved Up /
 Curved Down Jaws
 Round Bayonet Handle,
 Straight / Curved Up /
 Curved Down Jaws

Micro Needle Holders
 W/Round Bayonet Handle 23.5cm 9.5"

REVERDIN NEEDLES

Reverdin nadeln | Aguilles de reverdin
 agujas de reverdin | aghi di reverdin



Reverdin Needle
short



HI-07-390
14.5cm, 5 3/4"



HI-07-391
14.5cm, 5 3/4"



HI-07-392
14.5cm, 5 3/4"



HI-07-393
14.5cm, 5 3/4"



Reverdin Needle
HI-07-394-
HI-07-397
Small



HI-07-394
19.5cm, 7 3/4"
HI-07-398
23cm, 9"



HI-07-395
19.5cm, 7 3/4"
HI-07-399
23cm, 9"



HI-07-396
19.5cm, 7 3/4"
HI-07-400
23cm, 9"



HI-07-397
19.5cm, 7 3/4"
HI-07-401
23cm, 9"



Reverdin Needle
HI-07-398-
HI-07-401
long

LIGATUER NEEDLES

Unterbindungsnadeln | Aiguilles à ligatures
 agujas para ligaduras | aghi di legatura

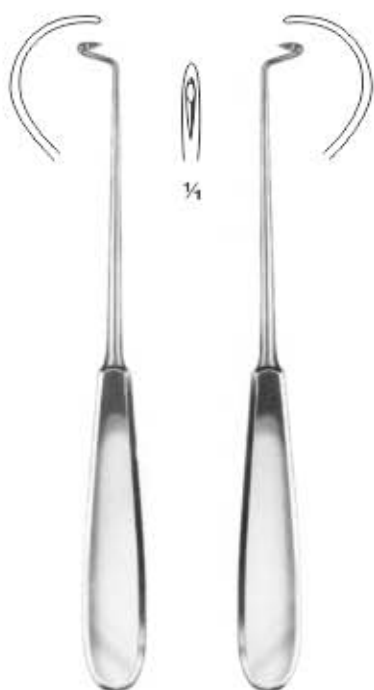

Deschamps Needle
HI-07-402 **HI-07-403**
 20cm, 8" 20cm, 8"
 sharp sharp
 for right hand for left hand

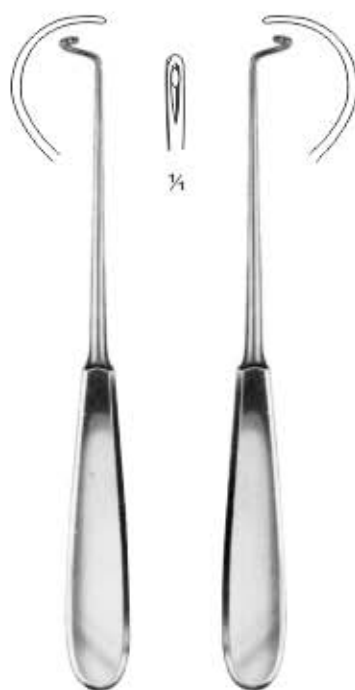

Deschamps Needle
HI-07-404 **HI-07-405**
 20cm, 8" 20cm, 8"
 blunt blunt
 for right hand for left hand



Deschamps Needle
HI-07-406 **HI-07-407**
 21cm, 8 1/4" 21cm, 8 1/4"
 blunt blunt
 for right hand for left hand

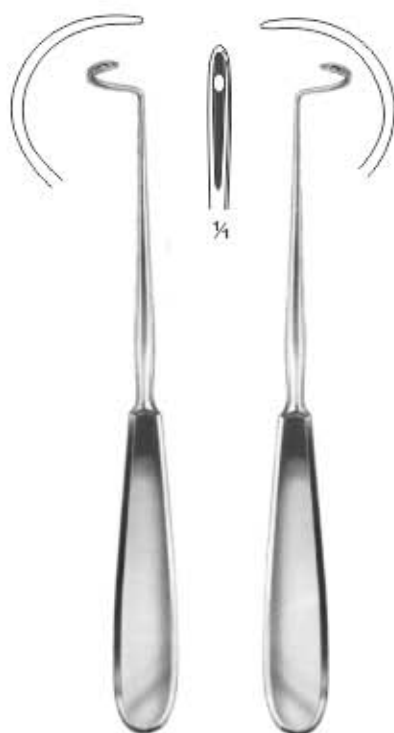

Deschamps Needle
HI-07-408 **HI-07-409**
 20cm 20cm
 blunt blunt
 for right hand for left hand



Deschamps Needle
HI-07-410 **HI-07-411**
 20cm 20cm
 sharp sharp
 for right hand for left hand

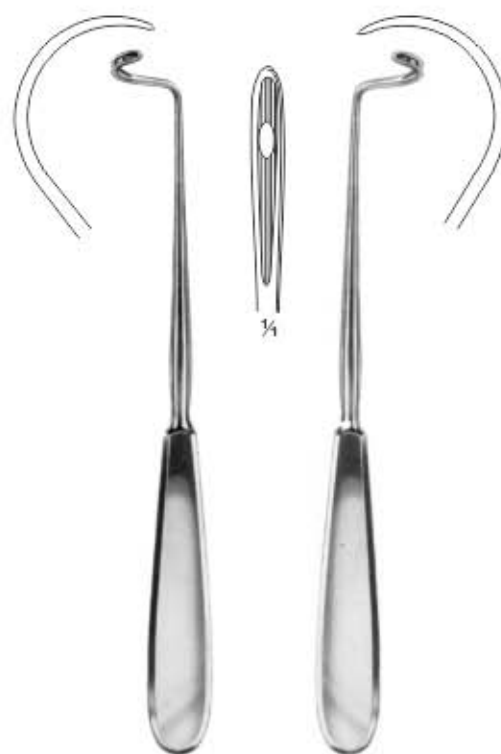

Deschamps Needle
HI-07-412 **HI-07-413**
 20cm 20cm
 blunt blunt
 for right hand for left hand

LIGATURE NEEDLES



Unterbindungsnadeln | Aiguilles à ligatures
 agujas para ligaduras | aghi di legatura



Deschamps Needle
 HI-07-414 HI-07-415
 20cm, 8" 20cm, 8"
 sharp sharp
 for right for left
 hand hand

Deschamps Needle
 HI-07-416 HI-07-417
 27cm, 10 3/4" 27cm, 10 3/4"
 blunt blunt
 for right for left
 hand hand

Deschamps Needle
 HI-07-418 HI-07-419
 27cm, 10 3/4" 27cm, 10 3/4"
 sharp sharp
 for right for left
 hand hand

Deschamps Needle
 HI-07-420 HI-07-421
 28cm, 11" 28cm, 11"
 blunt blunt
 for right for left
 hand hand



BOWMAN LACRIMAL PROBES

Double Ended, Sterling Silver

HI-07-422

Bowman Probe,
000-0000

HI-07-423

Bowman Probe,
00-0

HI-07-424

Bowman Probe,
1-2

HI-07-425

Bowman Probe,
3-4

HI-07-426

Bowman Probe,
5-6

HI-07-427

Bowman Probe,
7-8

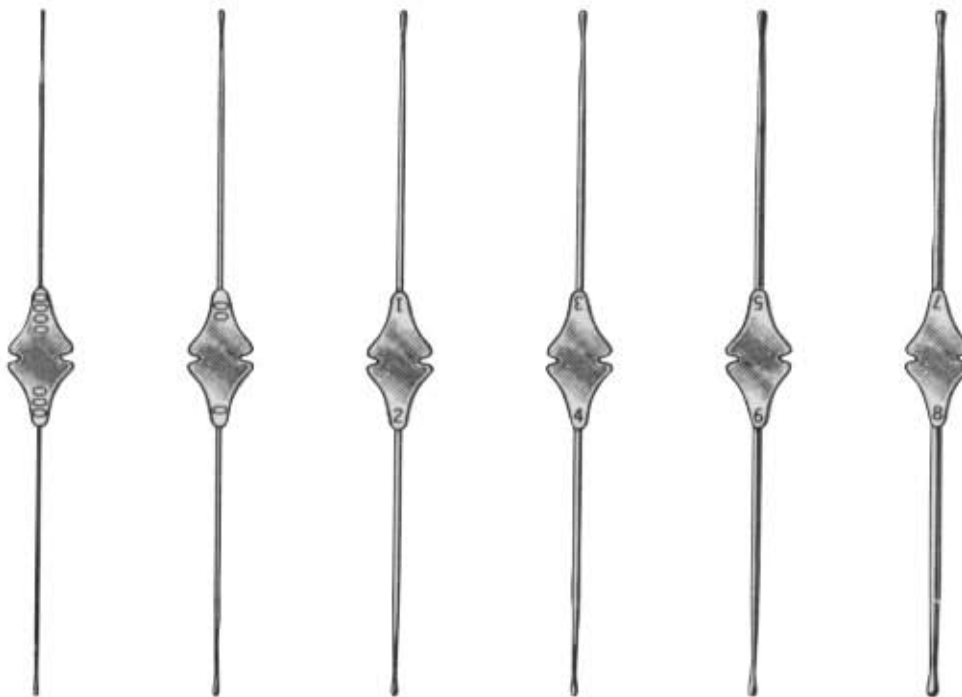

WILLIAM LACRIMAL PROBES

Double Ended, Sterling Silver

HI-07-428

William Probe,
000-0000

HI-07-429

William Probe,
00-0

HI-07-430

William Probe,
1-2

HI-07-431

William Probe,
3-4

HI-07-432

William Probe,
5-6

HI-07-433

William Probe,
7-8

PROBE & DIRECTORS



Allgemeines Instrumentarium
Instrumental general

Instrumentation générale
Strumentario generale



DIRECTORS
HI-07-434 13 cm, 5"
HI-07-435 14.5 cm, 5 3/4"
HI-07-436 16 cm, 6"
 LARRY Probe and
 Grooved Director, 7" 17.8 cm



DOYEN
HI-07-437
 14.5 cm, 5 3/4"



NELATON
HI-07-438
 16 cm, 6"



DIRECTOR
Probe End
HI-07-439
 14 cm, 5 1/2"
 Director with tip
 Diam. Of tip 3.3 mm

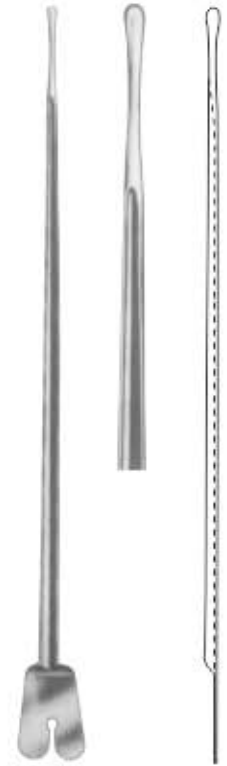

BRODIE
HI-07-440
 20 cm, 8"
 Director with tip
 Diam. Of tip 3.5 mm

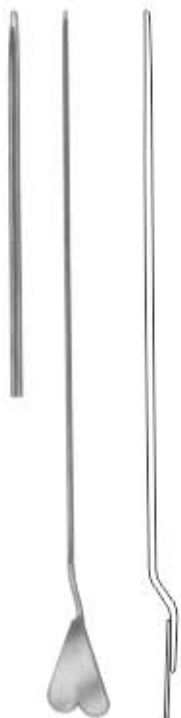

LOCKHART-MUMMERY
HI-07-441
 16.5 cm, 6 1/2"

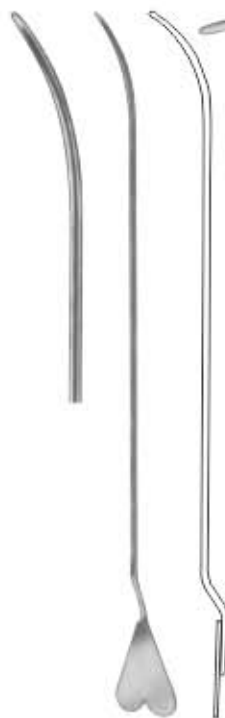

LOCKHART-MUMMERY
HI-07-442
 16.5 cm, 6 1/2"

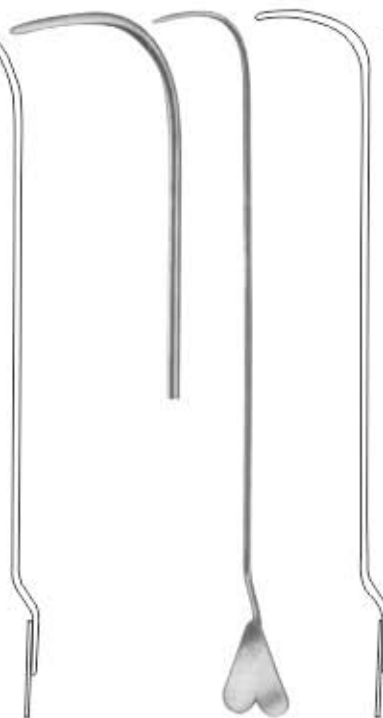

LOCKHART-MUMMERY
HI-07-443
 16.5 cm, 6 1/2"

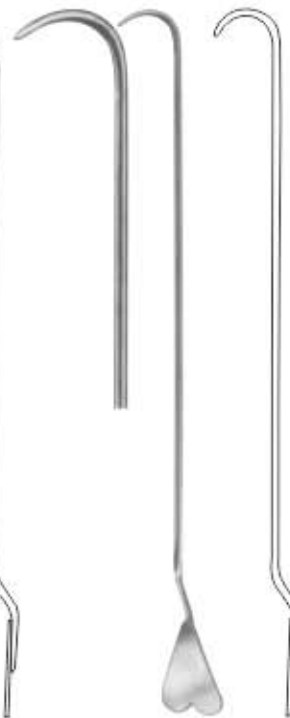

LOCKHART-MUMMERY
HI-07-444
 16.5 cm, 6 1/2"



DIRECTOR
 with wire
 loop, malleable
HI-07-445
 19 cm, 7 1/4"



Probes With Eye
HI-07-446 14.5 cm, 5 3/4"
HI-07-447 16.0 cm, 6 1/4"
HI-07-448 20.0 cm, 8"



Myrtle Leaf Probe
HI-07-449 14.5 cm, 5 3/4"



Myrtle Leaf Probe
HI-07-450 13.0 cm, 5"
HI-07-451 14.5 cm, 5 3/4"
HI-07-452 16.0 cm, 6 1/4"
HI-07-453 18.5 cm, 7"
HI-07-454 20.0 cm, 8"



Probe
HI-07-455



WILDER Lacrimal Dilator,
HI-07-456
 10.2 cm 4"
 medium taper



HI-07-457
 19.0 cm, 8 1/4"
 Double ended probe,
 malleable, diam, of tips
 3 mm with hole



HI-07-458 25.0 cm, 10"
HI-07-459 30.0 cm, 12"
 Double ended probes,
 tin, malleable, diam, of tips
 3.5 mm with hole



HI-07-460
 40.0 cm, 15 3/4"
 Double ended probes,
 tin, malleable, diam, of tips
 4 mm with hole



HI-07-461 1.5 mm
HI-07-462 2.0 mm
HI-07-463 2.5 mm
 30.0 cm, 12"



CLIPS MAYO
HI-07-463A 14cm

PROBE & SPATULA



Allgemeines Instrumentarium
Instrumental general

Instrumentation générale
Strumentario generale



STACKE
HI-07-464
10.0 cm, 4"



KILLIAN
HI-07-465
16.5 cm, 6 1/2"



HI-07-466
16.5 cm, 6 1/2"



SEIFFERT
HI-07-467
18.0 cm, 7"



SPATULA
HI-07-468
14.5 cm, 5 3/4"



SPATULA
HI-07-469
14.5 cm, 5 3/4"



MODELL PICCOLO
HI-07-470
11.0 cm, 4 1/4"
Round Serrated



MODELL PICCOLO
HI-07-471 11.0 cm, 4 1/4"
Triangular Serrated end



FARRELL
HI-07-472
11.0 cm, 4 1/4"
Round Serrated end



LATHBURY-FARRELL
HI-07-473
11.0 cm, 4 1/4"
Triangular Serrated end

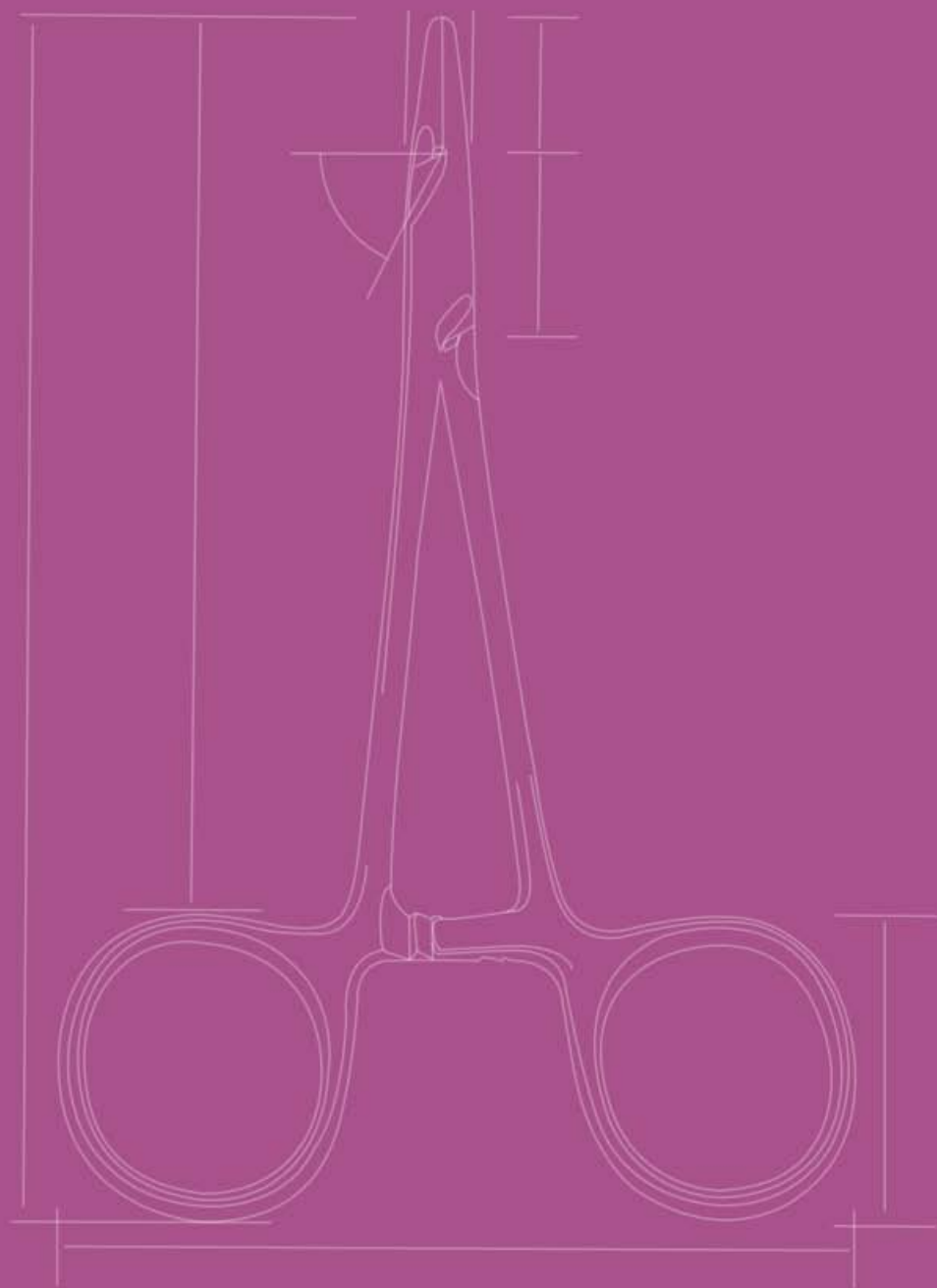

HOMEDICA
INTERNATIONAL