

Surgical Instruments Catalogue

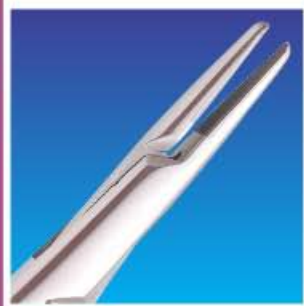

HOMEDICA
INTERNATIONAL



HOMEDICA INTERNATIONAL

Homedica feels great honor introducing itself to be one of the leading manufacturing company of surgical & dental instruments. Professional always prefer Homedica instruments, which is our pride.

Our all instruments are manufactured by the high quality stainless steel made on our requirements, every instrument is hand crafted with the highest workmanship available in the industry. Through heat treatment, the instruments are hardened and tempered for proper functioning and long life. All instruments are polished electrolytically and manually for maximum resistance to corrosion and long life. Homedica pays special attention to the needs of doctors, with innovative designs to meet the needs of professionals. The wide assortment of standard patterns and exclusive Homedica designs gives you the most desirable range of surgical and dental instruments.

Over the several years, we have earned the reputation of for maintaining highest quality standards of quality and service. To manufacture instruments that meet with your changing demands is our achievement. Our highly skilled staff of professionals will continue to serve your needs and will try their outmost to uplift the standards which we have set in the past.

With your co-operation and guidance, Homedica will continue serving surgical and dental instruments in future.

Management of Homedica international

BASIC METHODS FOR HANDLING AND CARE OF SURGICAL AND DENTAL INSTRUMENTS

Dear Customers:

We have received some questions concerning staining, pitting or rusting in stainless steel instruments. So, we took great honour and pleasure in guiding our respected customers to eliminate the problems about staining or rusting etc. The points are as follows:-

- 1) Rinse the instruments as soon as possible after use to remove blood and serum.
- 2) Dry the instruments after cleaning or before wrapping and storing, if not so, moisture left can cause rust and corrosion.
- 3) Do not leave instruments in cold sterilization solution for a long period, as the solution may lead the instrument to be corrosive.
- 4) Never use caustic cleaners, use those specified for cleaning surgical instruments.
- 5) Avoid cleaning instruments with steel wool; if want to clean with hand, use detergent soap and a soft brush and finally treat with distilled water.
- 6) You should check your autoclave; Iron, calcium, sodium or copper in water can cause rusting, staining or corrosion.
- 7) Leaving of instruments for a long time in the following solutions can also cause corrosion.
 - i) Phenol or Iodine.
 - ii) Aluminium, Barium or Calcium.
 - iii) Any Acid, Mercury or Potassium solution.
- 8) Try your utmost not to sterilize stainless steel instrument with chrome plated brass instruments, as any break in chrome surface may cause pitting or rusty surface in instruments.
- 9) Muslin wraps should be rinsed sufficiently by the laundry, so that all chlorine bleach may remove, which can cause corrosion or custing during autoclaving.

We hope that by acting on the above instructions, your problems relating to rusting, staining or pitting would abolish and the age of your instrument would increase.

MANAGEMENT

INTESTINAL AND RECTAL INSTRUMENTS

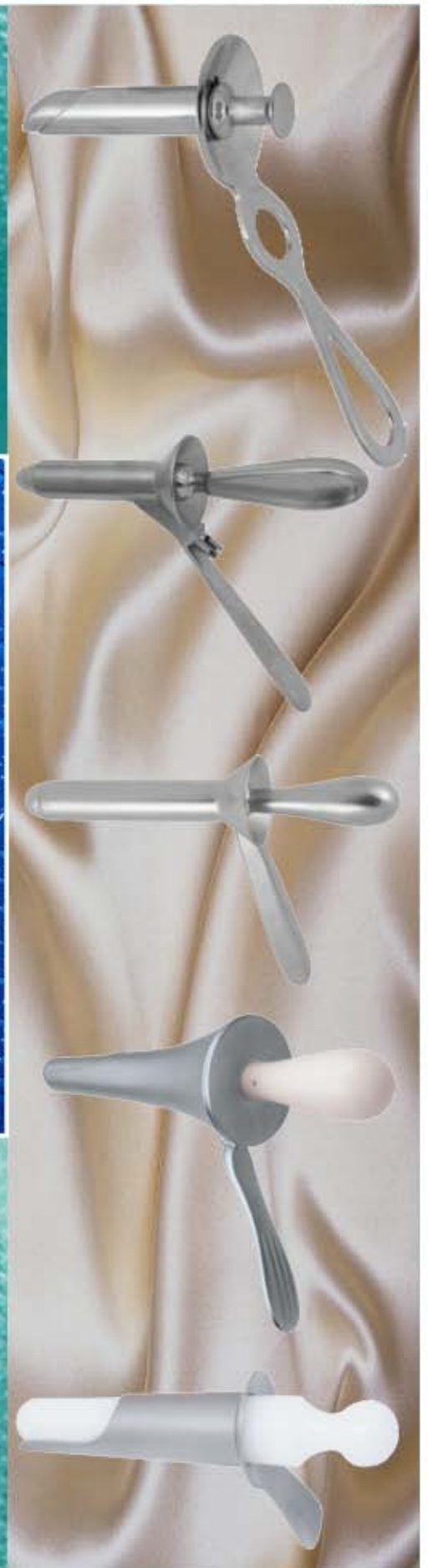

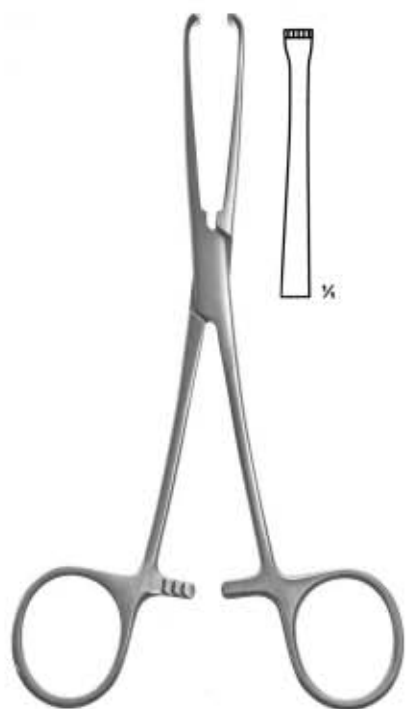

Allis Tissue Forceps
 HI-12-001
 3 x 4 teeth
 15.5 cm, 6"

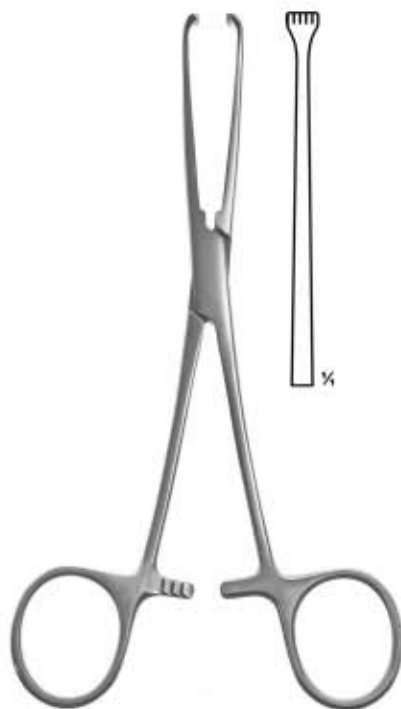

Allis Tissue Forceps
 HI-12-002
 4 x 5 teeth
 15.5 cm, 6"



Allis Tissue Forceps
 HI-12-003 19.0 cm, 7 1/2"
 HI-12-004 25.5 cm, 10"
 5 x 6 teeth



Baby Allis Tissue Forceps
 HI-12-005
 14 cm 5 1/2" 4 X 5 teeth
 delicate jaws 4 mm wide



Judd-Allis Tissue Forceps
 HI-12-006
 3 x 4 teeth
 19.5 cm, 7 3/4"



Williams Grasp Forceps
 HI-12-007
 16 cm, 6 1/2"

INTESTINAL & TISSUE GRASPING FORCEPS

Darm-und Gewebefasszangen | Pincés Pour Saisir Intestins et Tissus
 Pinzas Para Intestinos y Tejidos | Pinze Per Afferrare Intestino e Tessuti

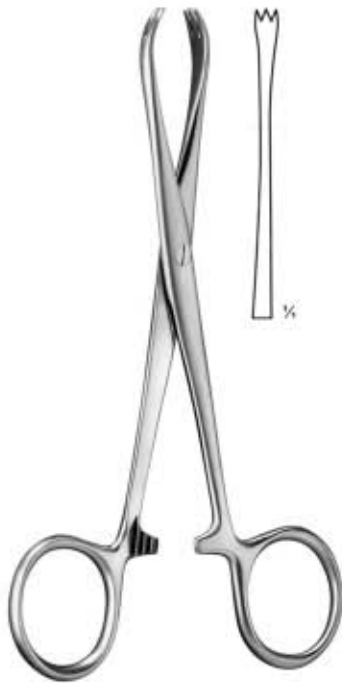

Chaput Tissue Forceps
 HI-12-008
 2 x 3 teeth, sharp
 12.5 cm, 5"

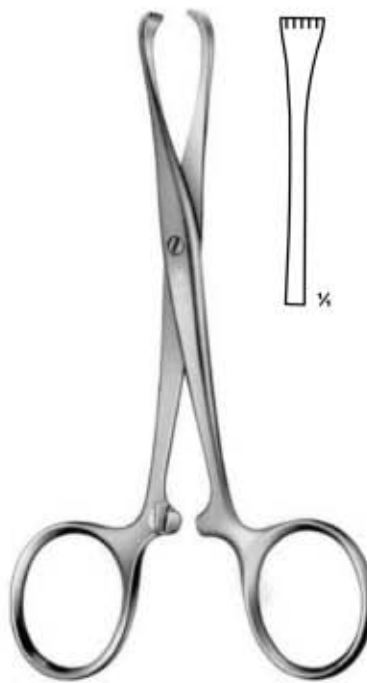

Tuffier Tissue Forceps
 HI-12-009
 5 x 6 teeth, sharp
 12.5 cm, 5"



Boys-Allis Tissue Forceps
 HI-12-010
 5 x 6 teeth, sharp
 15.5 cm, 6"



Duval-Collin Grasp Forceps
 HI-12-011 19.5 cm, 7 3/4"
 HI-12-012 20.0 cm, 8"

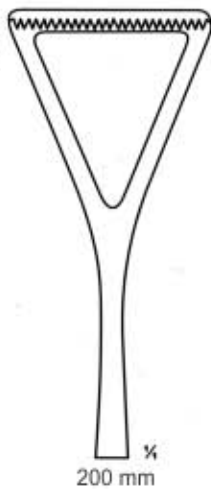

Duval Grasp Forceps
 HI-12-013
 23.0 cm, 9"

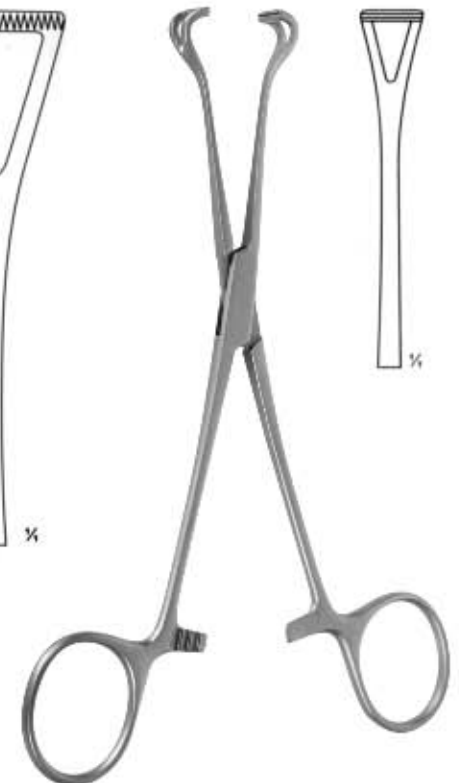

Babcock Seizing Forceps
 HI-12-014
 15.5 cm, 6"



HI-12-015
17.0 cm, 6 3/4"

Babcock Seizing Forceps



HI-12-016
21.5 cm, 8 1/2"



Babcock Seizing Forceps
HI-12-017
22.0 cm, 8 3/4"



Babcock Tissue Grasping Forceps
HI-12-018 18 cm, 7"
HI-12-019 24 cm, 9 1/2"



HI-12-020
16.0 cm, 6 1/4"

HI-12-021
21.5 cm, 8 1/4"

Babcock Tissue Grasping Forceps

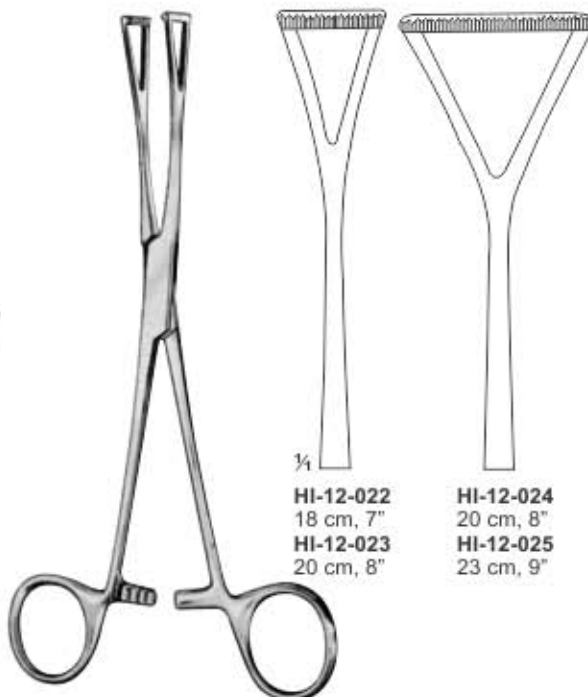

HI-12-022
18 cm, 7"
HI-12-023
20 cm, 8"

HI-12-024
20 cm, 8"
HI-12-025
23 cm, 9"

Duval Tissue Grasping Forceps

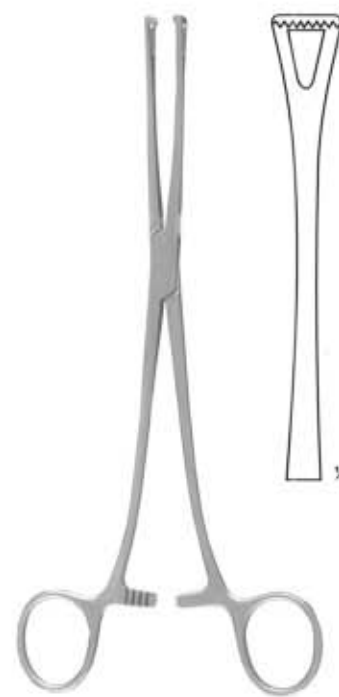

Lockwood Grasp Forceps
HI-12-026
20.0 cm, 8"

INTESTINAL & TISSUE GRASPING FORCEPS

Darm-und Gewebefasszangen | Pincas Pour Saisir Intestins et Tissus
 Pinzas Para Intestinos y Tejidos | Pinze Per Afferrare Intestino e Tessuti



Little Wood Tissue Grasping Forceps
 HI-12-027 19 cm, 7 1/2"
 Box Joint



Lane Tissue Grasping Forceps
 HI-12-028 12.7 cm, 5"
 HI-12-029 15 cm, 6"
 HI-12-030 19 cm, 7 1/2"



HI-12-031
 25 cm, 10"



HI-12-032
 27 cm, 10 3/4"



Babcock Intestinal & Tissue Grasping Clamp Forceps T.C



HI-12-033 16.5 cm, 6 1/2"
 HI-12-034 20.3 cm, 8"

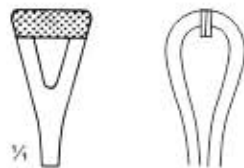

HI-12-035
 17.5 cm, 7"

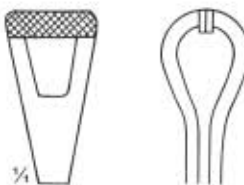

HI-12-036
 19.5 cm, 8"



Duval Intestinal & Tissue Grasping Clamp Forceps T.C



HI-12-037
 13 cm, 5 1/4"



HI-12-038
 18 cm, 7"

INTESTINAL CLAMPS

Darmklemmen | Pincas Intestinales

Pinzas Intestinales | Pinze Intestinali

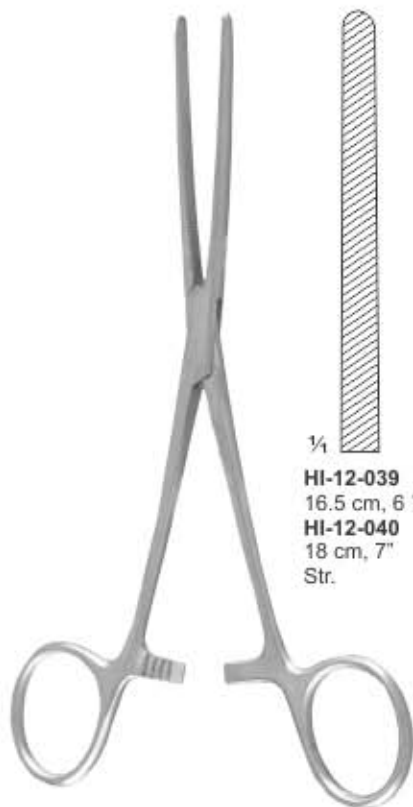

Baby-Doyen Intestinal Forceps Clamps

 $\frac{3}{4}$
HI-12-039
 16.5 cm, 6 $\frac{1}{2}$ "
HI-12-040
 18 cm, 7"
 Str.



HI-12-041
 16.5 cm, 6 $\frac{1}{2}$ "
HI-12-042
 18 cm, 7"
 Cvd.

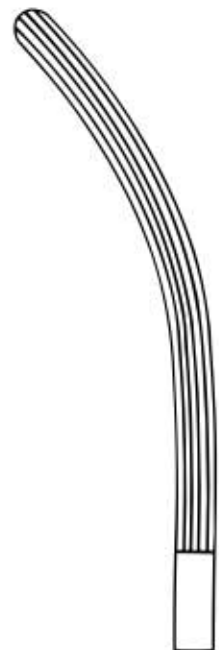

Mayo-Robson Intestinal Forceps Clamps

 $\frac{3}{4}$
HI-12-043
 21 cm, 8 $\frac{1}{4}$ "
HI-12-044
 23 cm, 9"
HI-12-045
 25 cm, 10"
 Str.

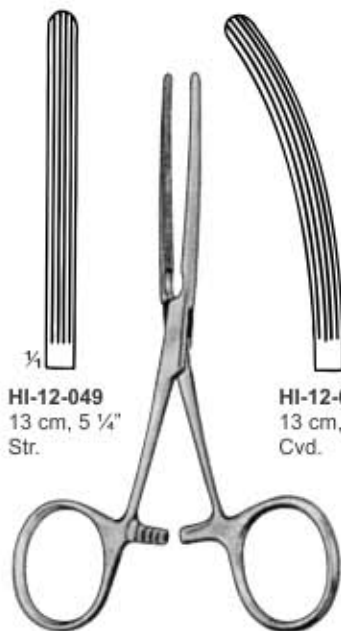
HI-12-046
 21 cm, 8 $\frac{1}{4}$ "
HI-12-047
 23 cm, 9"
HI-12-048
 25 cm, 10"
 Cvd.



Baby-Kocher Intestinal Forceps Clamps

 $\frac{3}{4}$
HI-12-049
 13 cm, 5 $\frac{1}{4}$ "
 Str.

HI-12-050
 13 cm, 5 $\frac{1}{4}$ "
 Cvd.



Kocher Intestinal Forceps Clamps

 $\frac{3}{4}$
HI-12-051
 22 cm, 8 $\frac{3}{4}$ "
 Straight

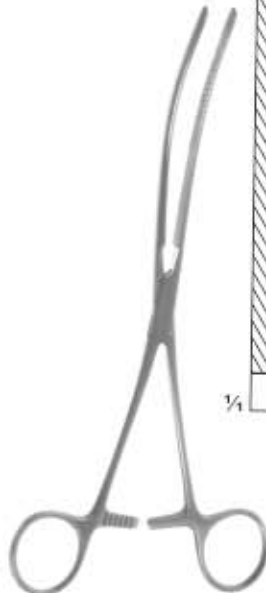

Doyen Intestinal Forceps Clamps

 $\frac{3}{4}$
HI-12-052
 21 cm, 8 $\frac{1}{4}$ "
HI-12-053
 23 cm, 9"
 straight,
 grooved

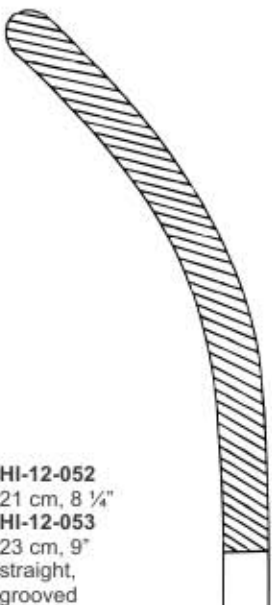
HI-12-054
 22 cm, 8 $\frac{3}{4}$ "
 Curved,
 grooved

POLYOUS GRASPING FORCEPS, ANASTOMOSIS



Polypenfasszange, Darm-anastomosenklemmen

Pince Pour Saisir Polypes, Pincés-clamps Pour Anastomose Intestinale

Pinza Para Coger Pólipos, Clamps Para Anastomosis Intestinales

Pinze Per Afferrare Polipi, Pinze Per Anastomosi Intestinali

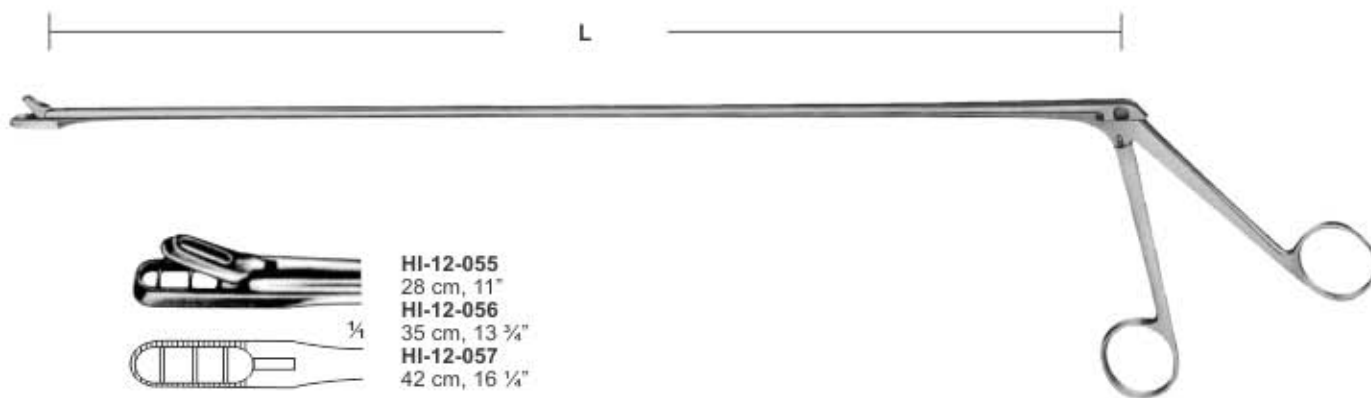

**Yeomann Intestinal
Polyous Grasping
Forceps**

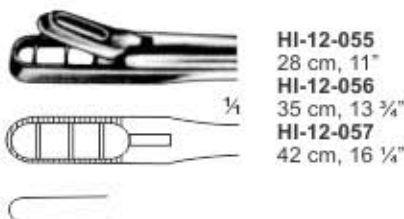

HI-12-055
28 cm, 11"
HI-12-056
35 cm, 13 3/4"
HI-12-057
42 cm, 16 1/4"

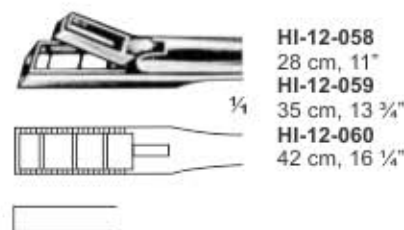

HI-12-058
28 cm, 11"
HI-12-059
35 cm, 13 3/4"
HI-12-060
42 cm, 16 1/4"

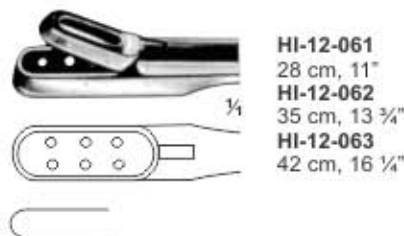

HI-12-061
28 cm, 11"
HI-12-062
35 cm, 13 3/4"
HI-12-063
42 cm, 16 1/4"

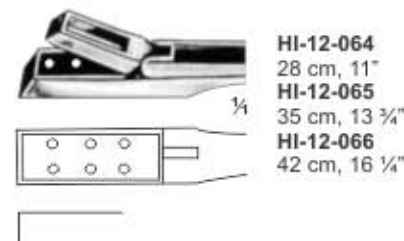

HI-12-064
28 cm, 11"
HI-12-065
35 cm, 13 3/4"
HI-12-066
42 cm, 16 1/4"

INTESTINAL CLAMPS

Darmklemmen | Pincas Intestinales
Pinzas Intestinales | Pinze Intestinali



Payr-Baby Crushing Intestinal Clamp

HI-12-067
15 cm, 6"
without pin
HI-12-068
15 cm, 6"
with pin

Payr Crushing Intestinal Clamp

HI-12-069
21 cm, 8 ¼"
without pin
HI-12-070
21 cm, 8 ¼"
with pin

Payr Crushing Intestinal Clamp

HI-12-071
29 cm, 11 ½"
without pin
HI-12-072
29 cm, 11 ½"
with pin

Payr Crushing Intestinal Clamp

HI-12-073
35 cm, 13 ¾"
without pin
HI-12-074
35 cm, 13 ¾"
with pin

INTESTINAL CLAMPS

Darmklemmen | Pincas Intestinales
Pinzas Intestinales | Pinze Intestinali



**Lane Stomach Intestinal
Clamp Forceps**
HI-12-075
30 cm, 12" Str.

**Lane Stomach Intestinal
Clamp Forceps**
HI-12-076
30 cm, 12" Cvd.



90 x 15 mm

Mathieu Rectal Speculum
 HI-12-077 19.5 cm, 7 3/4"
 90 x 15 mm



Sims Rectal Speculum
 HI-12-078 15 cm, 6"



Sims Rectal Speculum
 HI-12-079 15 cm, 6"



Barr Rectal Speculum
 HI-12-080 80mm
 Blade size



Ives-Fansler Rectal Speculum
 HI-12-081 14.5 mm, 5 3/4"
 22 mm Ø



Pratt Rectal Speculum
 HI-12-082 21.5 cm, 8 1/2"
 85 x 25 mm blade

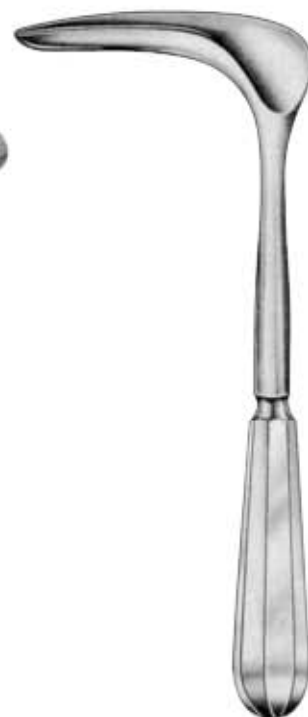

Czerny Rectal Speculum
 HI-12-083
 22 cm, 8 3/4"

INTESTINAL RECTAL SPECULA

Mastdarmspekula | Spéculums Rectaux
 Espéculos Rectales | Specoli Rettali



Hirschmann Intestinal Rectal Speculum
 HI-12-084
 23 mm Ø
 proctoscope
 working length: 145 mm



HI-12-085
 22 Ø x 50 mm
HI-12-086
 22 Ø x 100 mm
HI-12-087
 22 Ø x 140 mm
HI-12-088
 22 Ø x 200 mm

Kelly Intestinal Rectal Speculum



HI-12-089
 19 Ø x 70 mm
HI-12-090
 22 Ø x 70 mm

Bensaude Intestinal Rectal Speculum

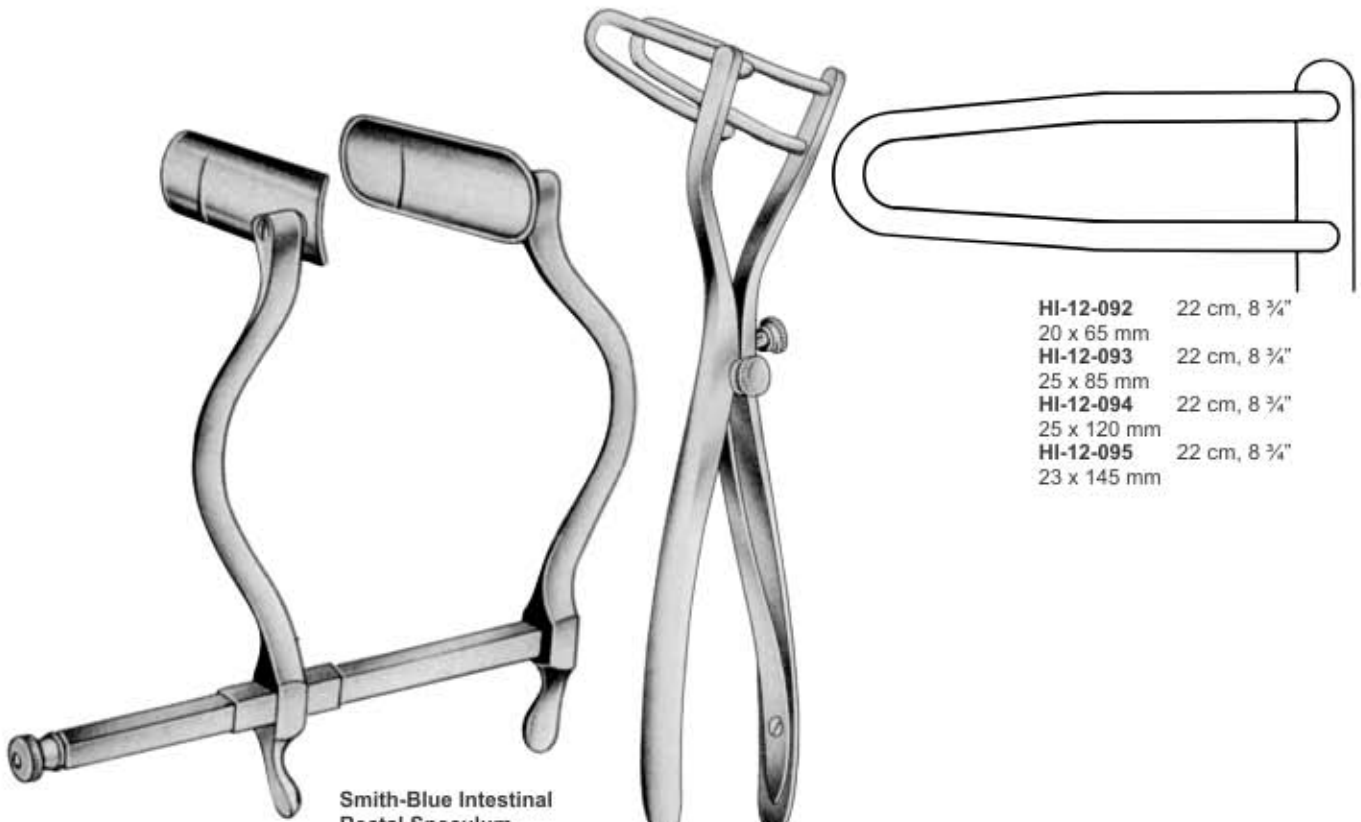

Smith-Blue Intestinal Rectal Speculum
 HI-12-091 15 cm, 6"
 75 x 23 mm

Schulze-Bergmann Intestinal Rectal Speculum

HI-12-092 22 cm, 8 3/4"
 20 x 65 mm
HI-12-093 22 cm, 8 3/4"
 25 x 85 mm
HI-12-094 22 cm, 8 3/4"
 25 x 120 mm
HI-12-095 22 cm, 8 3/4"
 23 x 145 mm



Barr-Shilford Intestinal Rectal Speculum
HI-12-096



Vernon-David Intestinal Rectal Speculum
with thumb grip handle
HI-12-097 short handle
HI-12-098 long (standard) handle



Fansler Operating Intestinal Rectal Speculum
with slotted / extra long handle
HI-12-101 standard
HI-12-102 25 mm x 65 mm (1" x 2 1/2")
HI-12-103 29 mm x 65 mm (1 1/4" x 2 1/2")
HI-12-104 38 mm x 70 mm (1 1/2" x 2 3/4")

with slotted tube / short handle
HI-12-105 29 mm x 60 mm (1 1/4" x 2 1/4")
HI-12-106 operating speculum



Chelsea-Eaton Intestinal Rectal Speculum
solid handle
HI-12-099 small
HI-12-100 large
with light connection available



Brinkerhoff Intestinal Rectal Speculum
HI-12-107 smal 3 1/2" x 1" tapers to 1/2"
HI-12-108 medium 4" x 1" tapers to 5/8"
HI-12-109 large 4 3/4" x 1 1/4" tapers to 3/4"

INTESTINAL RECTAL SPECULA

Mastdarmspekula | Spéculums Rectaux
 Espéculos Rectales | Specoli Rettali



**Ives-fansler Anoscope
 Intestinal Rectal Speculum**
 with hard rubber obturator /
 fenestrated handle
HI-12-110 22 mm x 85 mm



**Long Chrome Handle
 Intestinal Rectal Speculum**
HI-12-111 3 1/4" x 1 1/8"



Hirschman Anoscope Intestinal Rectal Speculum
HI-12-112 small 2 1/4" x 9/16" inside diameter
HI-12-113 medium 2 5/8" x 11/16" inside diameter
HI-12-114 large 3 1/2" x 7/8" inside diameter



**Buie Hirschman Anoscope Intestinal
 Rectal Speculum**
HI-12-115 small 2 1/4" x 9/16" inside diameter
HI-12-116 medium 3 3/4" x 3/4" inside diameter
HI-12-117 large 3 7/8" x 15/16" inside diameter



**Morgen Proctoscope
 Intestinal Rectal Speculum**
 with light connection
HI-12-118 17mm
HI-12-119 20mm
HI-12-120 24mm

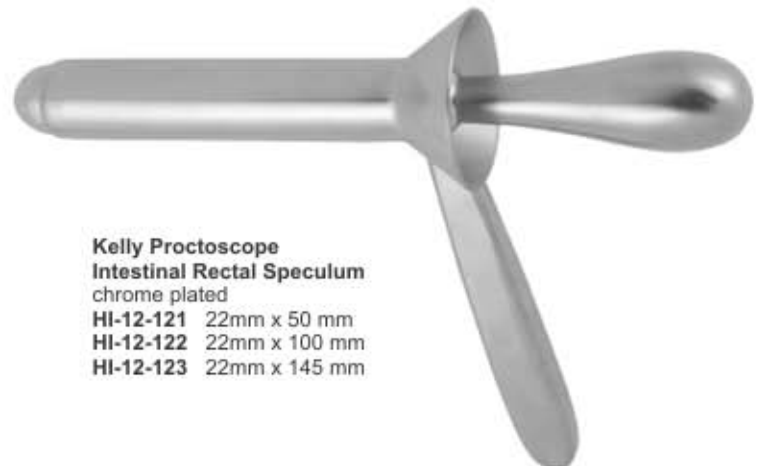

**Kelly Proctoscope
 Intestinal Rectal Speculum**
 chrome plated
HI-12-121 22mm x 50 mm
HI-12-122 22mm x 100 mm
HI-12-123 22mm x 145 mm

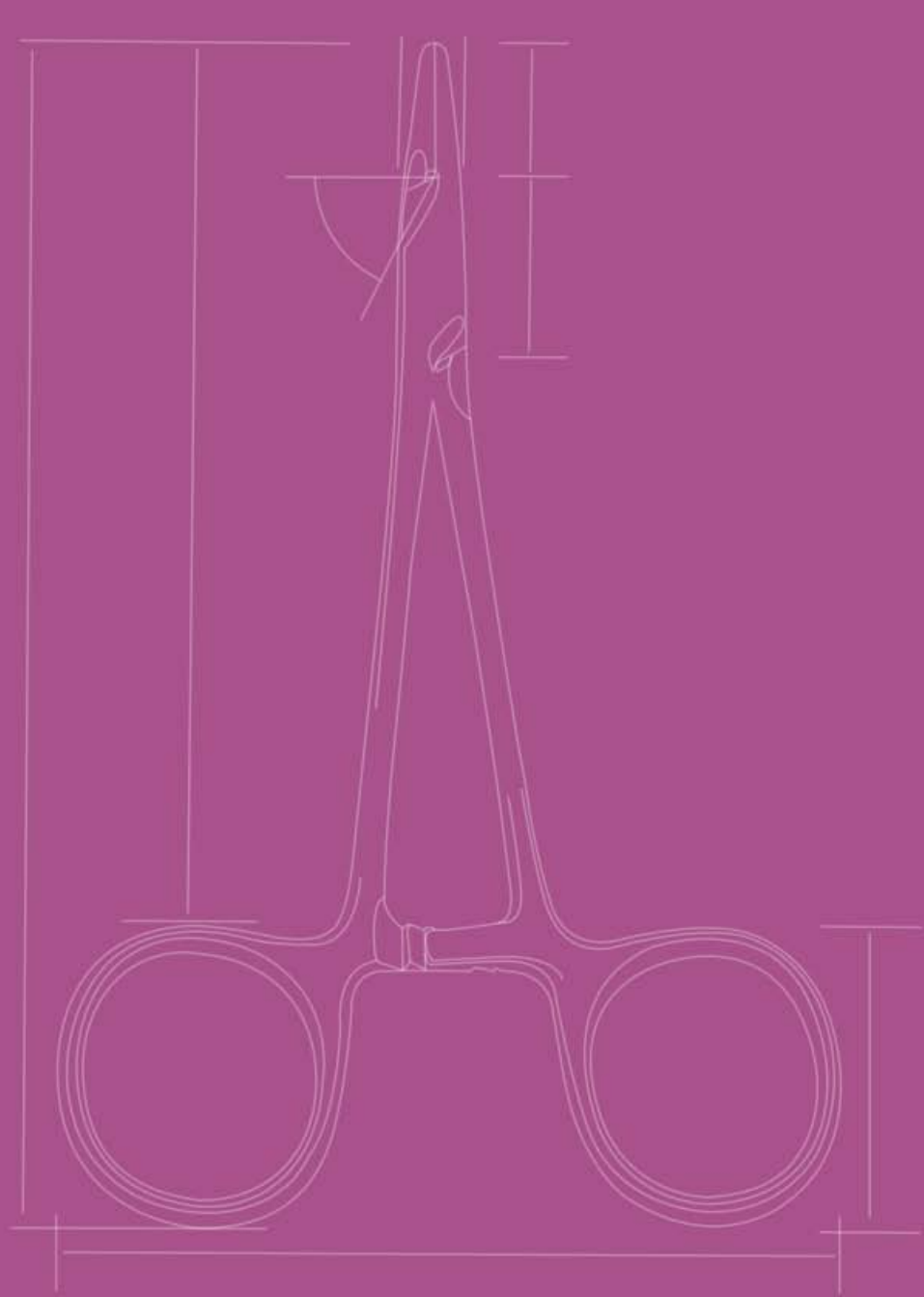

HOMEDICA
INTERNATIONAL