

# Surgical Instruments Catalogue

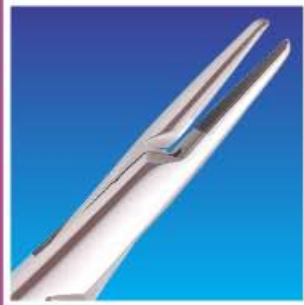

HOMEDICA  
INTERNATIONAL



## **HOMEDICA INTERNATIONAL**

Homedica feels great honor introducing itself to be one of the leading manufacturing company of surgical & dental instruments. Professional always prefer Homedica instruments, which is our pride.

Our all instruments are manufactured by the high quality stainless steel made on our requirements, every instrument is hand crafted with the highest workmanship available in the industry. Through heat treatment, the instruments are hardened and tempered for proper functioning and long life. All instruments are polished electrolytically and manually for maximum resistance to corrosion and long life. Homedica pays special attention to the needs of doctors, with innovative designs to meet the needs of professionals. The wide assortment of standard patterns and exclusive Homedica designs gives you the most desirable range of surgical and dental instruments.

Over the several years, we have earned the reputation of for maintaining highest quality standards of quality and service. To manufacture instruments that meet with your changing demands is our achievement. Our highly skilled staff of professionals will continue to serve your needs and will try their outmost to uplift the standards which we have set in the past.

With your co-operation and guidance, Homedica will continue serving surgical and dental instruments in future.

**Management of Homedica international**

## BASIC METHODS FOR HANDLING AND CARE OF SURGICAL AND DENTAL INSTRUMENTS

Dear Customers:

We have received some questions concerning staining, pitting or rusting in stainless steel instruments. So, we took great honour and pleasure in guiding our respected customers to eliminate the problems about staining or rusting etc. The points are as follows:-

- 1) Rinse the instruments as soon as possible after use to remove blood and serum.
- 2) Dry the instruments after cleaning or before wrapping and storing, if not so, moisture left can cause rust and corrosion.
- 3) Do not leave instruments in cold sterilization solution for a long period, as the solution may lead the instrument to be corrosive.
- 4) Never use caustic cleaners, use those specified for cleaning surgical instruments.
- 5) Avoid cleaning instruments with steel wool; if want to clean with hand, use detergent soap and a soft brush and finally treat with distilled water.
- 6) You should check your autoclave; Iron, calcium, sodium or copper in water can cause rusting, staining or corrosion.
- 7) Leaving of instruments for a long time in the following solutions can also cause corrosion.
  - i) Phenol or Iodine.
  - ii) Aluminium, Barium or Calcium.
  - iii) Any Acid, Mercury or Potassium solution.
- 8) Try your utmost not to sterilize stainless steel instrument with chrome plated brass instruments, as any break in chrome surface may cause pitting or rusty surface in instruments.
- 9) Muslin wraps should be rinsed sufficiently by the laundry, so that all chlorine bleach may remove, which can cause corrosion or custing during autoclaving.

We hope that by acting on the above instructions, your problems relating to rusting, staining or pitting would abolish and the age of your instrument would increase.

**MANAGEMENT**



# HAEMOSTATIC FORCEPS



# HAEMOSTATIC FORCEPS



Arterienklemmen  
Pincas Hemostaticas

Pinzas Hemostaticas  
Pinze Emostatiche

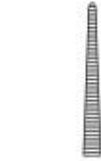

**HI-06-001**  
11.3 cm, 4 1/2"  
straight, serrated



**HI-06-002**  
11.3 cm, 4 1/2",  
curved, serrated



**HI-06-003**  
11.3 cm, 4 1/2", straight  
Haemostatic tissue  
(rat tooth 1x2 teeth)



**HI-06-004**  
11.3 cm, 4 1/2", curved  
Haemostatic tissue  
(rat tooth 1x2 teeth)

## Mosquito Haemostatic Forceps

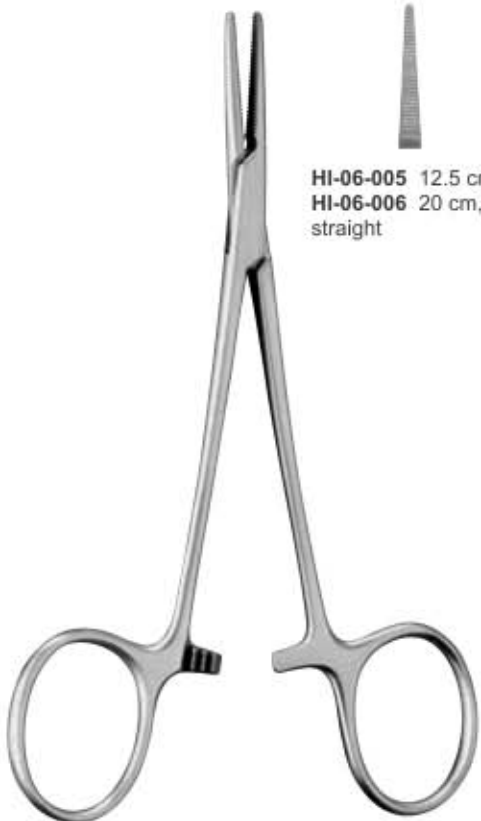

**HI-06-005** 12.5 cm, 5"  
**HI-06-006** 20 cm, 8"  
straight



**HI-06-007** 12.5 cm, 5"  
**HI-06-008** 20 cm, 8"  
curved



**HI-06-009** 12.5 cm, 5"  
**HI-06-010** 20 cm, 8"  
straight Left Handed



**HI-06-011** 12.5 cm, 5"  
**HI-06-012** 20 cm, 8"  
curved Left Handed

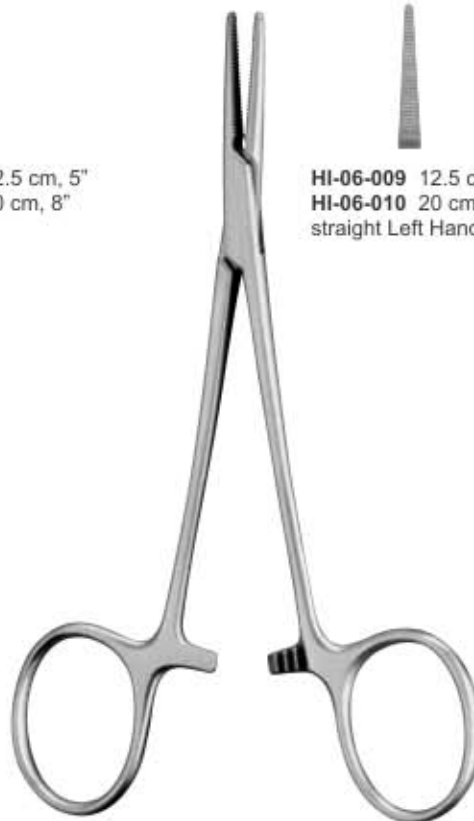

Halsted-Mosquito  
Haemostatic Forceps

Halsted-Mosquito  
Haemostatic Forceps



# HAEMOSTATIC FORCEPS

Arterienklemmen  
Pinces Hemostatiques

Pinzas Hemostaticas  
Pinze Emostatiche



**Kelly Haemostatic Forceps**

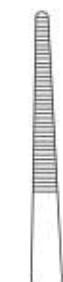

**HI-06-013**  
14.0 cm, 5 1/2"  
straight



**HI-06-014**  
14.0 cm, 5 1/2"  
curved



**HI-06-015**  
Kelly Haemostatic Fine  
point Forceps 14.0 cm  
5 1/2", straight



**HI-06-016**  
Kelly Haemostatic Fine  
point Forceps 14.0 cm  
5 1/2", curved



**Dandy Haemostatic Forceps**  
**HI-06-017** 14.0 cm, 5 1/2"  
Curved sideways



**Dandy Haemostatic  
Fine point Forceps**  
**HI-06-018** 14.0 cm, 5 1/2"  
Curved sideways



**Dandy Haemostatic  
Tissue Forceps**  
**HI-06-019** 14.0 cm, 5 1/2"  
(rat tooth 1x2 teeth)  
Curved sideways



**Dandy Haemostatic Fine  
point Tissue Forceps**  
**HI-06-020** 14.0 cm, 5 1/2"  
(rat tooth 1x2 teeth)  
Curved sideways

# HAEMOSTATIC FORCEPS



Arterienklemmen  
Pincas Hemostatiquas

Pinzas Hemostaticas  
Pinze Emostatiche

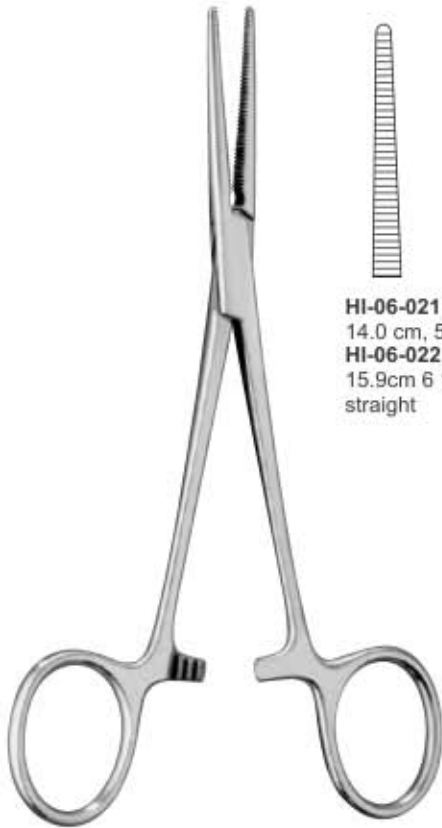

Crile Haemostatic Forceps

HI-06-021  
14.0 cm, 5 1/2"  
HI-06-022  
15.9cm 6 1/4"  
straight



HI-06-023  
14.0 cm, 5 1/2"  
HI-06-024  
15.9cm 6 1/4"  
curved

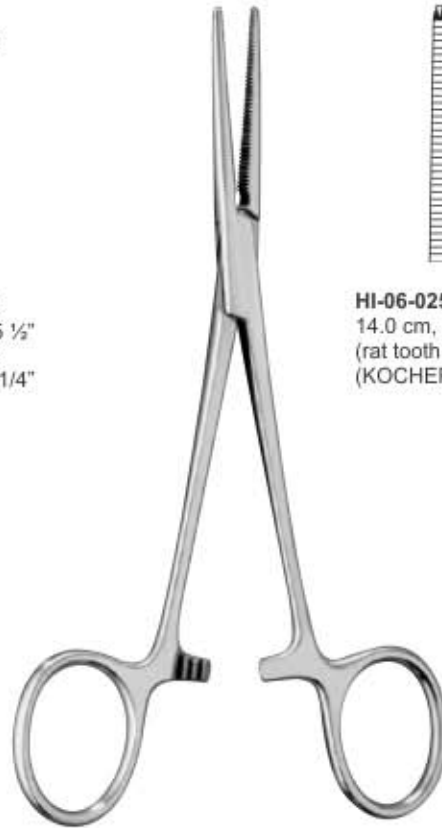

Crile Haemostatic  
Tissue Forceps

HI-06-025  
14.0 cm, 5 1/2"  
(rat tooth 1x2 teeth)  
(KOCHER) straight

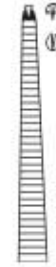

HI-06-026  
14.0 cm, 5 1/2"  
(rat tooth 1x2 teeth)  
(KOCHER) curved

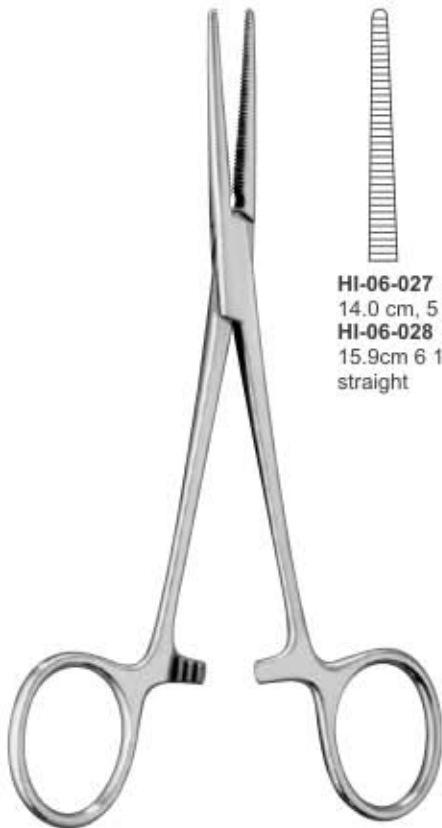

Crile Haemostatic  
Fine Point Forceps

HI-06-027  
14.0 cm, 5 1/2"  
HI-06-028  
15.9cm 6 1/4"  
straight



HI-06-029  
14.0 cm, 5 1/2"  
HI-06-030  
15.9cm 6 1/4"  
curved

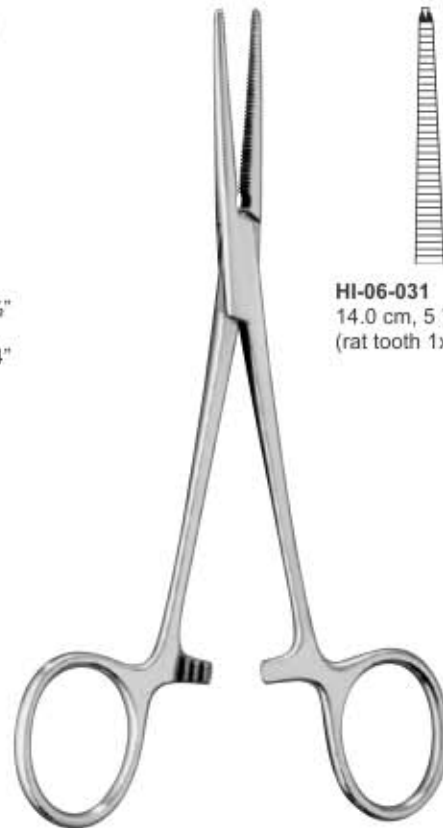
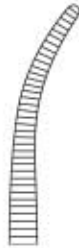

Crile Haemostatic Fine  
Point Tissue Forceps

HI-06-031  
14.0 cm, 5 1/2" straight  
(rat tooth 1x2 teeth)

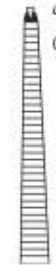

HI-06-032  
14.0 cm, 5 1/2" curved  
(rat tooth 1x2 teeth)



# HAEMOSTATIC FORCEPS

Arterienklemmen  
Pinces Hemostatiques

Pinzas Hemostaticas  
Pinze Emostatiche



**HI-06-033**  
18.5 cm, 7.25"  
straight



**HI-06-034**  
18.5 cm, 7.25"  
curved

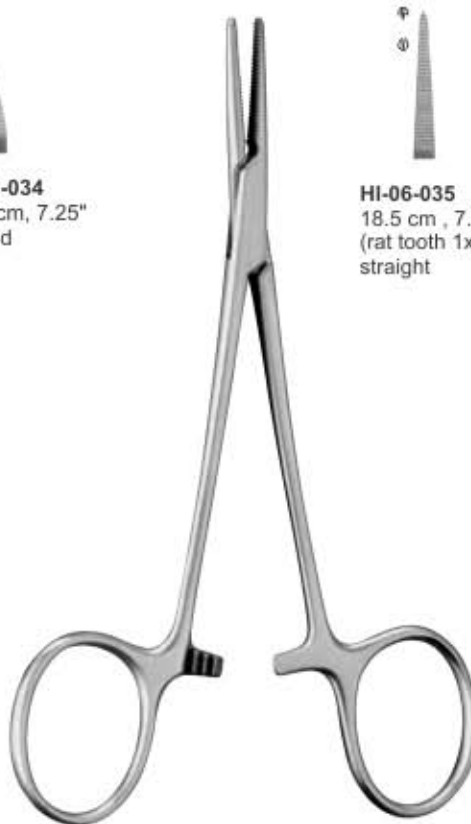

**HI-06-035**  
18.5 cm, 7.25"  
(rat tooth 1x2 teeth)  
straight



**HI-06-036**  
18.5 cm, 7.25"  
(rat tooth 1x2 teeth)  
curved

**Halsted Haemostatic Forceps**

**Halsted Haemostatic Tissue Forceps**



**HI-06-037**  
18.5 cm, 7.25"  
straight



**HI-06-038**  
18.5 cm, 7.25"  
curved



**HI-06-039**  
18.5 cm, 7.25"  
(rat tooth 1x2 teeth)  
straight



**HI-06-040**  
18.5 cm, 7.25"  
(rat tooth 1x2 teeth)  
curved

**Halsted Haemostatic Fine point Forceps**

**Halsted Haemostatic Fine Point Tissue Forceps**



# HAEMOSTATIC FORCEPS

Arterienklemmen  
Pincas Hemostatiques

Pinzas Hemostaticas  
Pinze Emostatiche



**Packer Mosquito Forceps**  
HI-06-041 5" , 12.7cm  
curved , flat jaws



HI-06-042 14 cm, 5 ½"  
HI-06-043 16 cm, 6 ¼"  
Straight, serrated

HI-06-044 14 cm, 5 ½"  
HI-06-045 16 cm, 6 ¼"  
Curved, serrated

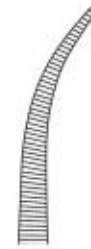

HI-06-046 13.0 cm, 5"  
HI-06-047 15.0 cm, 6"  
Curved, Serrated



HI-06-048 24 cm, 9 ½"  
Straight, Serrated

HI-06-049 24 cm, 9 ½"  
Curved Serrated



**Christophe Haemostatic Forceps**

**Saroot Haemostatic Forceps**

# HAEMOSTATIC FORCEPS

Arterienklemmen  
Pinces Hemostatiques

Pinzas Hemostaticas  
Pinze Emostatiche



**HI-06-050**  
18.5 cm, 7 ¼"  
straight

**HI-06-051**  
18.5 cm, 7 ¼"  
curved



**HI-06-052**  
18.5 cm, 7 ¼" straight  
(rat tooth 1x2 teeth)

**HI-06-053**  
18.5 cm, 7 ¼" Curved  
(rat tooth 1x2 teeth)

**Adson Haemostatic Fine point Forceps**

**Adson Haemostatic Tissue Forceps**



**HI-06-054** 15 cm, 6"  
**HI-06-055** 20 cm, 8"  
Curved

**HI-06-056** 15 cm, 6"  
**HI-06-057** 20 cm, 8"  
Curved Fine Point

**O'Shaughnessy Haemostatic Forceps**



**HI-06-058**  
14.5 cm, 5 ¾" Straight,  
box joint, as above but  
curved on flat.

**Cairns Haemostatic Forceps**

# HAEMOSTATIC FORCEPS

Arterienklemmen  
Pincas Hemostatiques

Pinzas Hemostaticas  
Pinze Emostatiche



**Pean Haemostatic Forceps  
Slender Type**

**HI-06-059** 13.0 cm, 5"  
**HI-06-060** 14.0 cm, 5 1/2"  
straight

**HI-06-061** 13.0 cm, 5"  
**HI-06-062** 14.0 cm, 5 1/2"  
curved

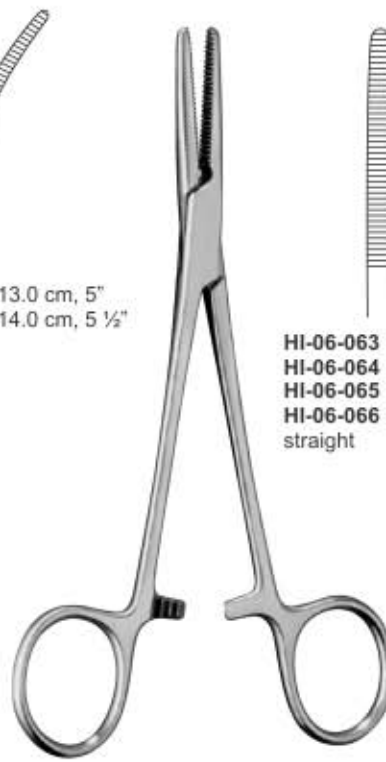

**Spencer-Wells Haemostatic Forceps  
Slender Type**

**HI-06-063** 13.0 cm, 5"  
**HI-06-064** 15.0 cm, 6"  
**HI-06-065** 17.5 cm, 7"  
**HI-06-066** 20 cm, 8"  
straight

**HI-06-067** 13.0 cm, 5"  
**HI-06-068** 15.0 cm, 6"  
**HI-06-069** 17.5 cm, 7"  
**HI-06-070** 20 cm, 8"  
curved



**Kocher Haemostatic  
Forceps Strong Pattern**

**HI-06-071**  
14.5cm, 5 3/4"  
Straight



**Kocher Haemostatic Forceps  
1x2 teeth**

**HI-06-072** 13cm, 5"  
**HI-06-073** 14cm, 5 1/2"  
straight

**HI-06-074** 13cm, 5"  
**HI-06-075** 14cm, 5 1/2"  
curved



# HAEMOSTATIC FORCEPS

Arterienklemmen

Pinzas Hemostaticas

Pinces Hemostatiques

Pinze Emostatiche



**HI-06-076**  
14 cm, 5.5"  
straight



**HI-06-077**  
16cm, 6 ¼"  
straight



**HI-06-078**  
18.5cm, 7 ¼"  
straight



**HI-06-079**  
20cm, 8"  
straight



**HI-06-080**  
22.5cm, 9"  
straight

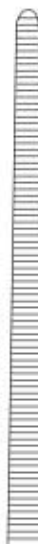

**HI-06-081**  
24cm, 9 ¾"  
straight



**HI-06-082**  
25.4 cm, 10"  
straight



**HI-06-083**  
27.9 cm, 11"  
straight



**Rochester-Pean  
Haemostatic Forceps  
Straight**

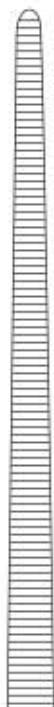

**HI-06-084**  
30.5 cm,  
12"  
straight



**HI-06-085**  
35.6 cm,  
14"  
straight



**HI-06-086**  
40.64 cm,  
16"  
straight



**HI-06-087**  
45.72 cm,  
18"  
straight



**HI-06-088**  
50.8 cm,  
20"  
straight



**HI-06-089**  
55.88 cm,  
22"  
straight



**HI-06-090**  
60.96 cm,  
24"  
straight

# HAEMOSTATIC FORCEPS



Arterienklemmen  
Pincas Hemostaticas

Pinzas Hemostaticas  
Pinze Emostatiche



**Rochester-Pean  
Haemostatic Forceps  
Curved**

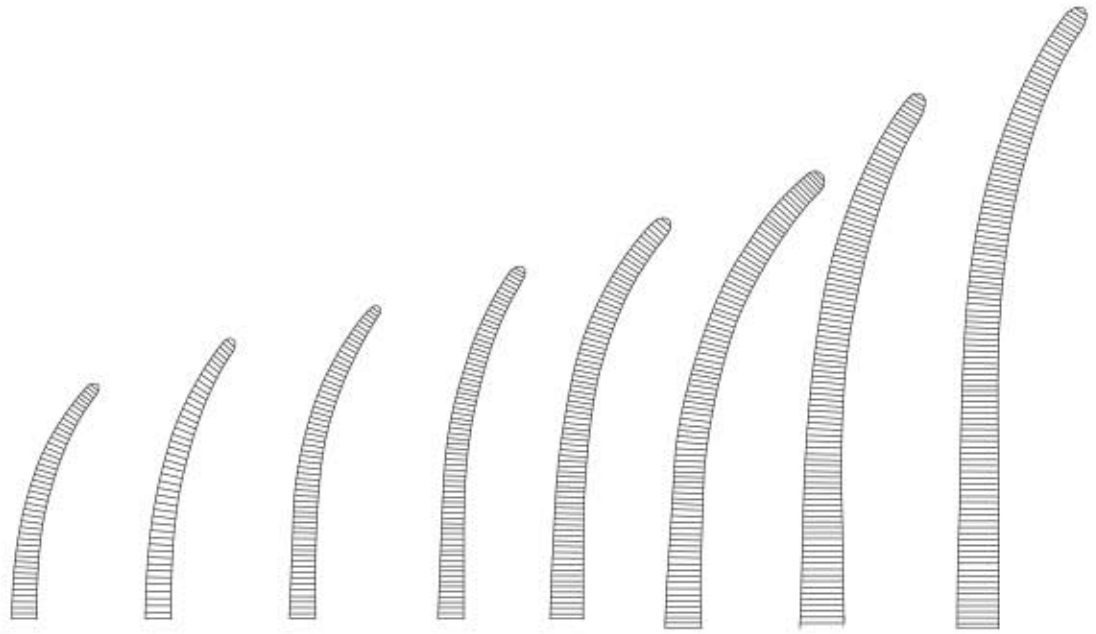

- |   |  |  |  |  |  |  |  |
|---|--|--|--|--|--|--|--|
| <b>HI-06-091</b><br>14 cm, 5.5"<br>Curved | <b>HI-06-092</b><br>16cm, 6 ¼"<br>Curved | <b>HI-06-093</b><br>18.5cm, 7 ¼"<br>Curved | <b>HI-06-094</b><br>20cm, 8"<br>Curved | <b>HI-06-095</b><br>22.5cm, 9"<br>Curved | <b>HI-06-096</b><br>24cm, 9 ¾"<br>Curved | <b>HI-06-097</b><br>25.4 cm, 10"<br>Curved | <b>HI-06-098</b><br>27.9 cm, 11"<br>Curved |
|---|--|--|--|--|--|--|--|

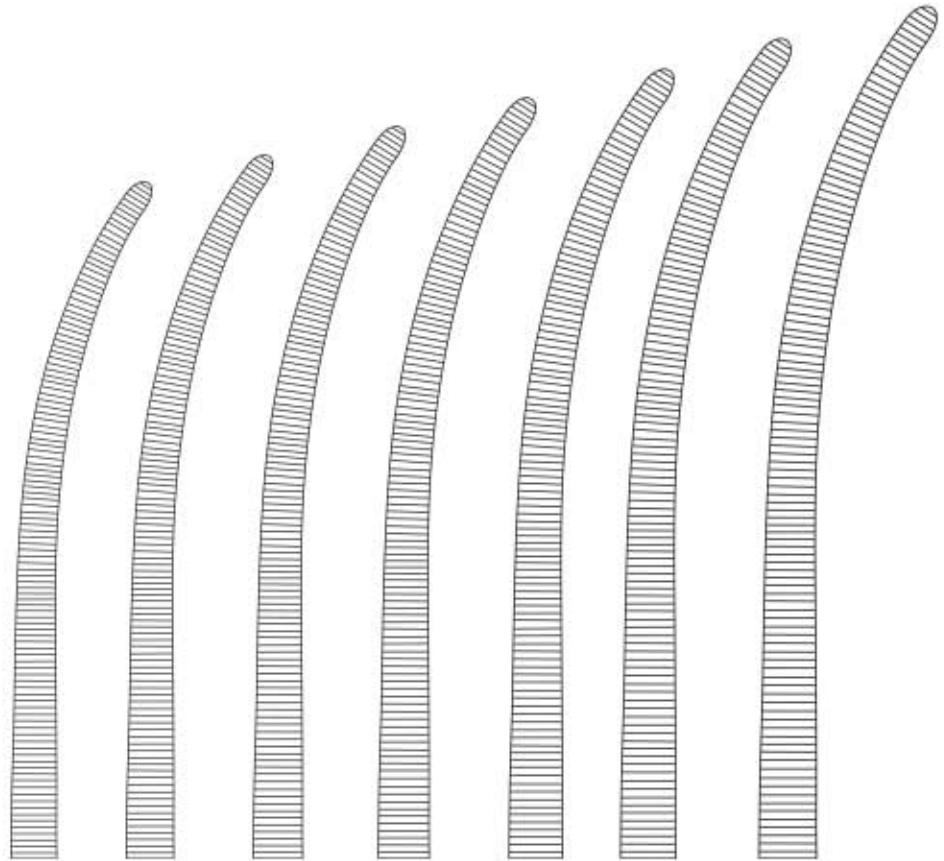

- |   |   |  |  |   |  |  |
|---|---|--|--|---|--|--|
| <b>HI-06-099</b><br>30.5 cm,<br>12"<br>Curved | <b>HI-06-100</b><br>35.6 cm,<br>14"<br>curved | <b>HI-06-101</b><br>40.64 cm,<br>16"<br>curved | <b>HI-06-102</b><br>45.72 cm,<br>18"<br>curved | <b>HI-06-103</b><br>50.8 cm,<br>20"<br>curved | <b>HI-06-104</b><br>55.88 cm,<br>22"<br>curved | <b>HI-06-105</b><br>60.96 cm,<br>24"<br>curved |
|---|---|--|--|---|--|--|

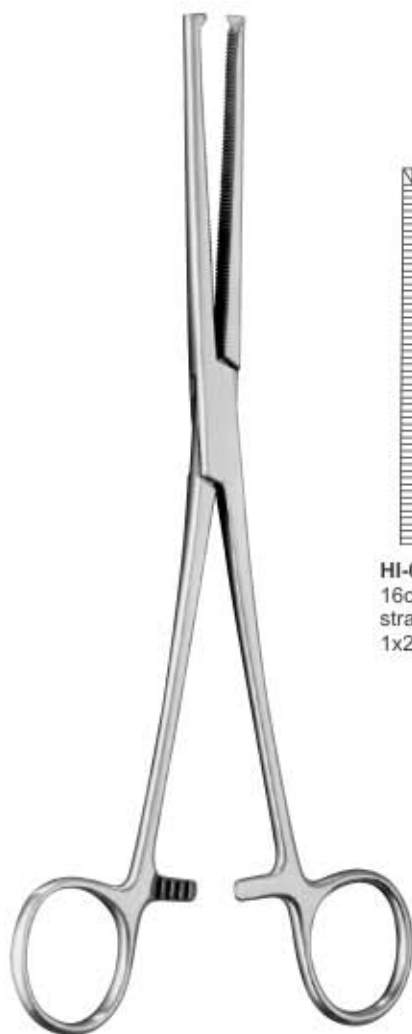

**Kocher-Ochsner  
Haemostatic Forceps**  
1x2 teeth

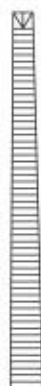

**HI-06-106**  
16cm, 6 1/4"  
straight  
1x2 teeth



**HI-06-107**  
18.5cm, 7 1/4"  
straight  
1x2 teeth

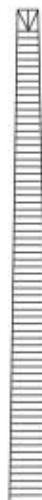

**HI-06-108**  
20cm, 8"  
straight  
1x2 teeth



**HI-06-109**  
22.5cm, 9"  
straight  
1x2 teeth



**HI-06-110**  
24.0cm, 9 3/4"  
straight  
1x2 teeth



**HI-06-111**  
26cm, 10 1/4"  
straight  
1x2 teeth

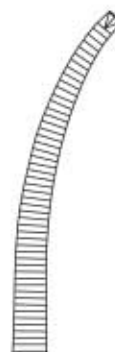

**HI-06-112**  
16cm, 6 1/4"  
Curved  
1x2 teeth

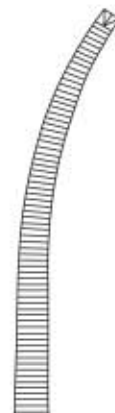

**HI-06-113**  
18.5cm, 7 1/4"  
Curved  
1x2 teeth



**HI-06-114**  
20cm, 8"  
Curved  
1x2 teeth

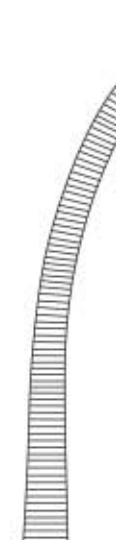

**HI-06-115**  
22.5cm, 9"  
Curved  
1x2 teeth



**HI-06-116**  
24.0cm, 9 3/4"  
Curved  
1x2 teeth

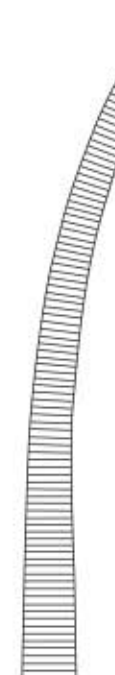

**HI-06-117**  
26cm, 10 1/4"  
Curved  
1x2 teeth



# HAEMOSTATIC FORCEPS



Arterienklemmen  
Pincas Hemostatiques

Pinzas Hemostaticas  
Pinze Emostatiche



**HI-06-118**  
15.9cm, 6 1/4"  
**HI-06-119**  
20.3cm 8"  
Straight

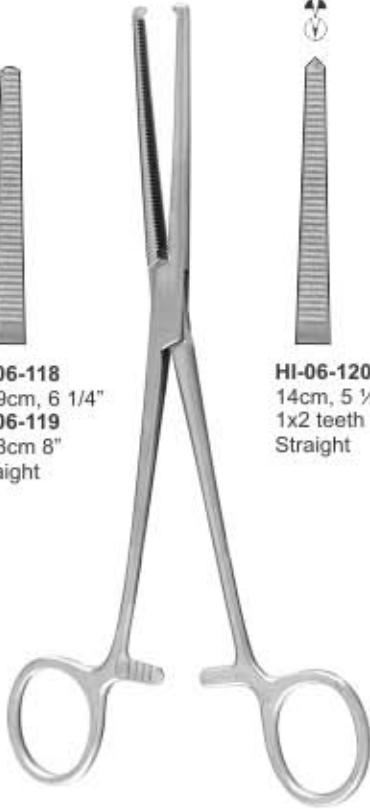

**Rochester-Ochsner  
Haemostatic Forceps**



**HI-06-120**  
14cm, 5 1/2"  
1x2 teeth  
Straight



**HI-06-121**  
14cm, 5 1/2"  
1x2 teeth  
Curved



**Rochester-Carmalt  
Haemostatic Forceps**



**HI-06-122**  
16 cm, 6 1/4"  
**HI-06-123**  
20 cm, 8"  
Straight



**HI-06-124**  
16 cm, 6 1/4"  
**HI-06-125**  
20 cm, 8"  
Curved

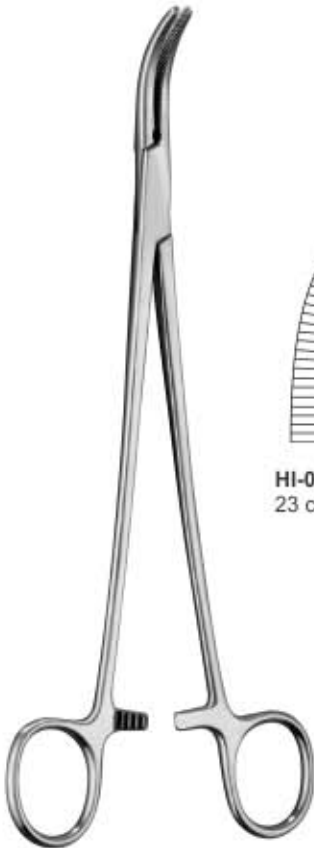

**Moynihan Haemostatic Forceps**



**HI-06-126**  
23 cm, 9"

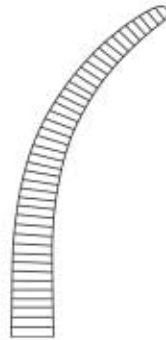

**HI-06-127**  
24 cm, 9 3/4"



**Negus Haemostatic Forceps**

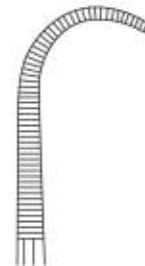

**HI-06-128**  
19.5 cm, 7 3/4"

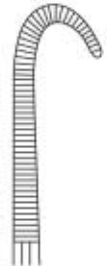

**HI-06-129**  
19.5 cm, 7 3/4"

# HAEMOSTATIC FORCEPS

Arterienklemmen  
Pinces Hemostatiques

Pinzas Hemostaticas  
Pinze Emostatiche

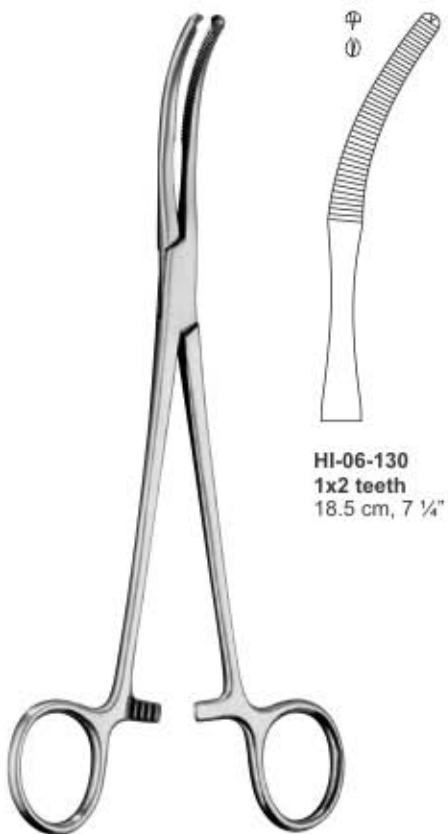

**HI-06-130**  
1x2 teeth  
18.5 cm, 7 1/4"

Mikulicz Haemostatic Tissue Forceps



**HI-06-131**  
Serrated  
21.5 cm, 8 1/2"

**HI-06-132**  
1x2 teeth  
21.5 cm, 8 1/2"

Halsted Haemostatic Forceps



**HI-06-133**  
24.5 cm, 9 3/4"  
straight

**HI-06-134**  
24.5 cm, 9 3/4"  
Curved

Bengolea Haemostatic Forceps



**HI-06-135**  
24.5 cm, 9 3/4"  
straight

**HI-06-136**  
24.5 cm, 9 3/4"  
Curved

Bengolea Haemostatic Tissue Forceps  
(rat tooth 1x2 teeth)

# HAEMOSTATIC FORCEPS



Arterienklemmen  
Pincas Hemostatiquas

Pinzas Hemostaticas  
Pinze Emostatiche



**Mixer-O'Shaugnessy  
Haemostatic Forceps**

- HI-06-137 14 cm, 5 1/2"
- HI-06-138 16.5 cm, 6 1/2"
- HI-06-139 19 cm, 7 1/2"
- HI-06-140 21.5 cm, 8 1/2"
- HI-06-141 24 cm, 9 1/2"

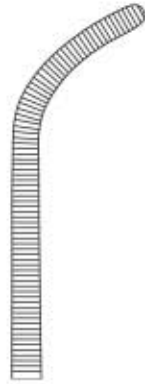

**Mixer-O'Shaugnessy  
Haemostatic Forceps**

- HI-06-142 14 cm, 5 1/2"
- HI-06-143 16.5 cm, 6 1/2"
- HI-06-144 19 cm, 7 1/2"
- HI-06-145 21.5 cm, 8 1/2"
- HI-06-146 24 cm, 9 1/2"
- Fine Point

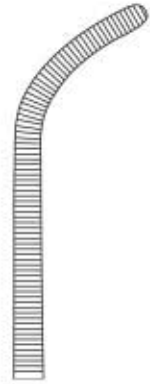

**Mixer-O'Shaugnessy  
Haemostatic Forceps**

- HI-06-147 14cm, 5 1/2"
- HI-06-148 16.5cm, 6 1/2"
- HI-06-149 19cm, 7 1/2"
- HI-06-150 21.5cm, 8 1/2"
- HI-06-151 24cm, 9 1/2"
- micro point



**Craford Haemostatic Forceps**

- HI-06-152  
24.5 cm, 9 3/4"

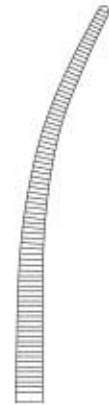



# HAEMOSTATIC FORCEPS

Arterienklemmen  
Pinces Hemostatiques

Pinzas Hemostaticas  
Pinze Emostatiche



**Herrick Haemostatic Forceps**  
HI-06-153 23.0 cm, 9"

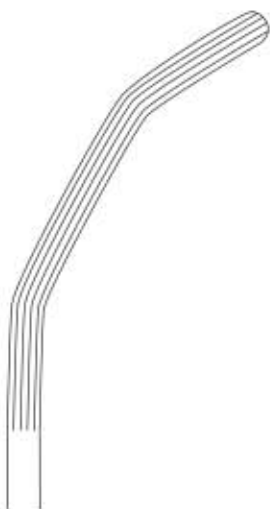

**Roberts Haemostatic Forceps**

**HI-06-154**  
22.0 cm, 8 ¾"  
straight

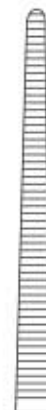

**HI-06-155**  
22.0 cm, 8 ¾"  
Curved



**Crafoord-Sellers  
Haemostatic Forceps**

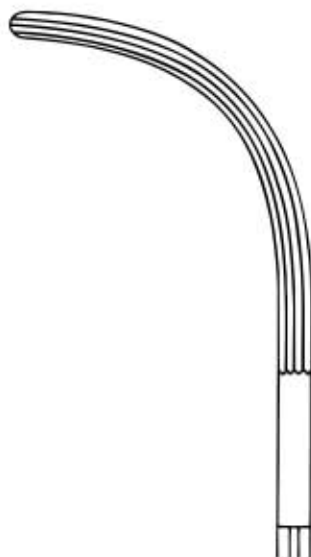

**HI-06-156**  
22.0 cm, 8 ¾"

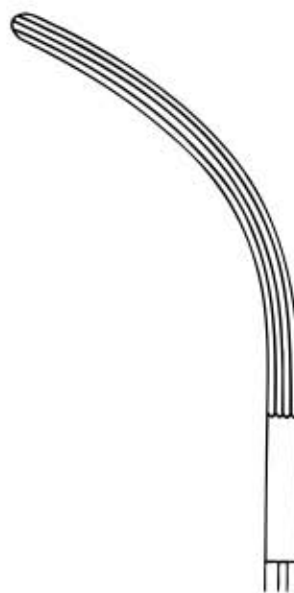

**HI-06-157**  
23.0 cm, 9"



**HI-06-158**  
24.0 cm, 9 ½"

# HAEMOSTATIC FORCEPS



Arterienklemmen  
Pincas Hemostatiquas

Pinzas Hemostaticas  
Pinze Emostatiche



**HI-06-159**  
20 cm, 8"  
Straight,  
Serrated

**Heaney / Ballantine  
Haemostatic Forceps**



**HI-06-160**  
20 cm, 8"  
Slight Curve,  
Serrated



**HI-06-161** 21 cm, 8 1/4"  
Straight, Cross Serrated  
**HI-06-162** 21 cm, 8 1/4"  
Slight curved, Cross  
Serrated

**Heaney / Rezak  
Haemostatic Forceps**



**HI-06-163**  
15.5 cm, 6"  
straight  
(1x2teeth)

**Dixon-Lovelace  
Haemostatic Tissue Forceps**

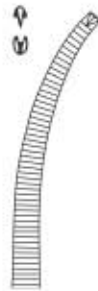

**HI-06-164**  
15.5 cm, 6"  
Curved  
(1x2teeth)

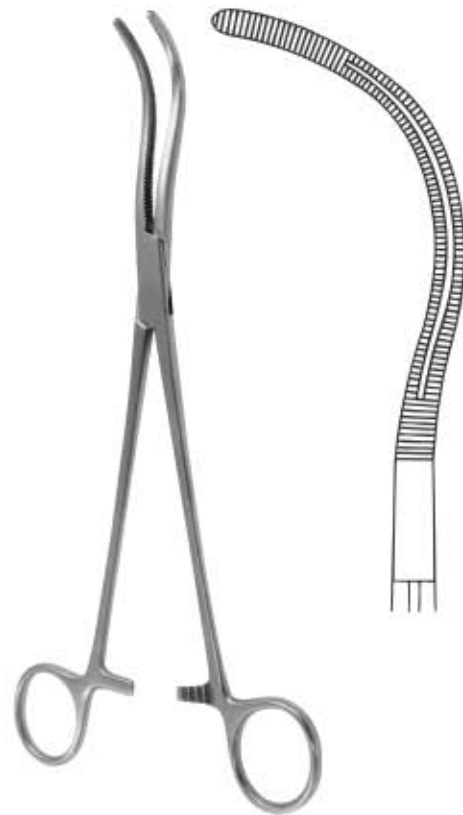

**Stille Haemostatic Forceps**  
**HI-06-165** 23 cm, 9"

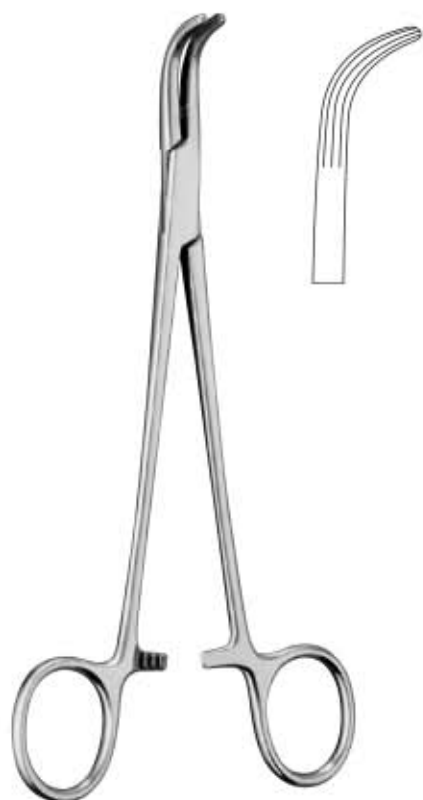

**Lower Haemostatic Forceps**  
HI-06-166 18cm, 7"

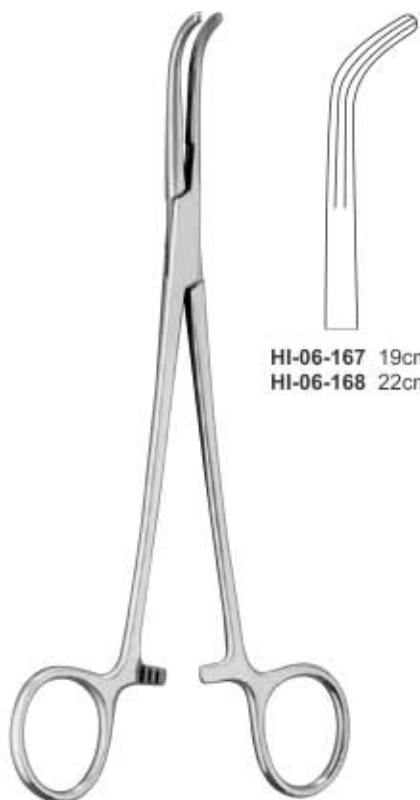

HI-06-167 19cm, 7 1/2"  
HI-06-168 22cm, 8 3/4"

**Lahey (Sweet)  
Haemostatic Forceps**



**Desjardins Haemostatic  
Forceps**  
HI-06-169 22cm, 8 3/4"



HI-06-170  
22cm, 8 3/4"

**Mixer Haemostatic  
Gall Duct Forceps**

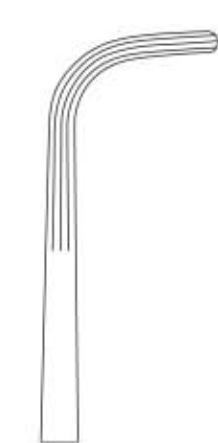

HI-06-171  
25cm, 10"

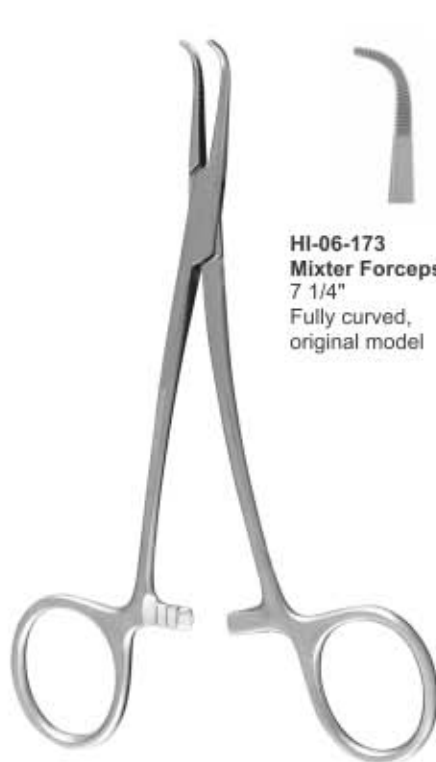

HI-06-173  
**Mixer Forceps**, 18.4 cm  
7 1/4"  
Fully curved,  
original model

**Mixer Forceps, Lee Modif**  
HI-06-172 13.3 cm, 5.25"  
Curved jaws and angled  
shanks, delicate

# HAEMOSTATIC FORCEPS



Arterienklemmen  
Pincas Hemostatiquas

Pinzas Hemostaticas  
Pinze Emostatiche



Heaney Haemostatic Forceps

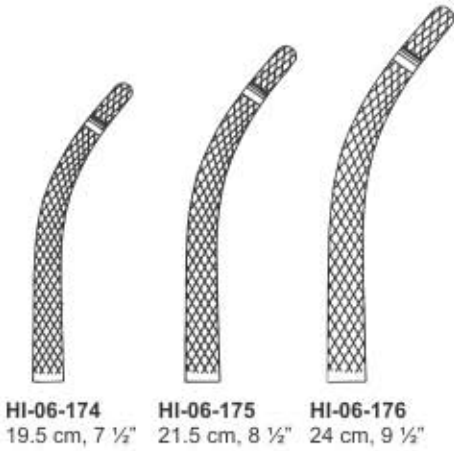

HI-06-174 19.5 cm, 7 1/2"  
HI-06-175 21.5 cm, 8 1/2"  
HI-06-176 24 cm, 9 1/2"

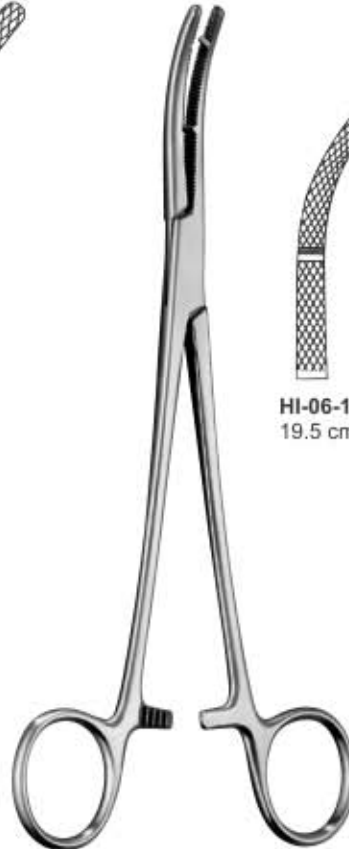

Heaney Modif. Haemostatic Forceps

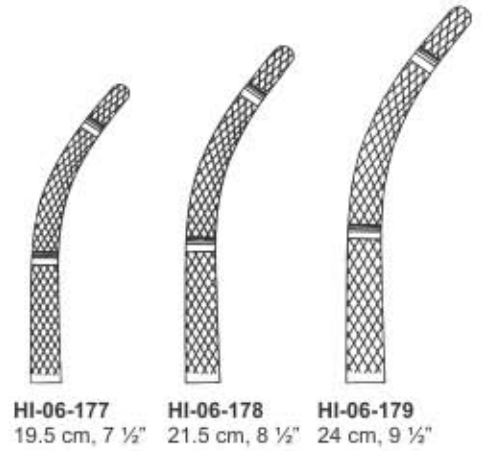

HI-06-177 19.5 cm, 7 1/2"  
HI-06-178 21.5 cm, 8 1/2"  
HI-06-179 24 cm, 9 1/2"



Heaney-Kanter Haemostatic Forceps



HI-06-180 21 cm, 8 1/4"

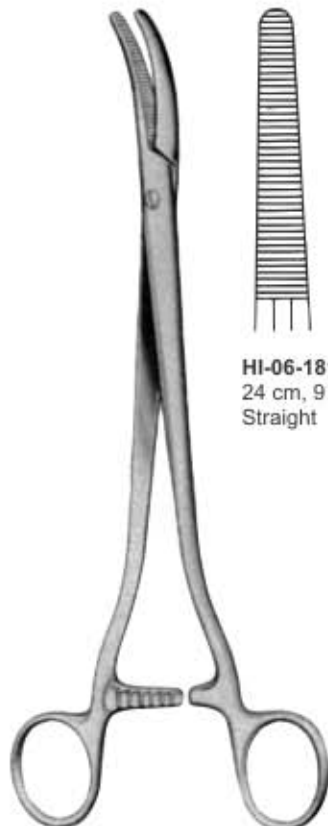

Segond-Landau Haemostatic Forceps

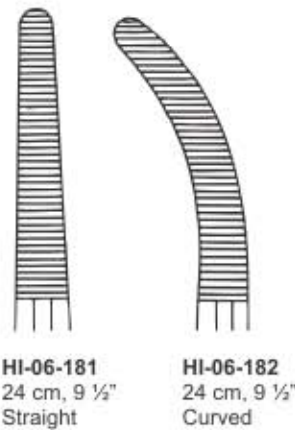

HI-06-181 24 cm, 9 1/2" Straight  
HI-06-182 24 cm, 9 1/2" Curved



Schindler Haemostatic Tissue Forceps

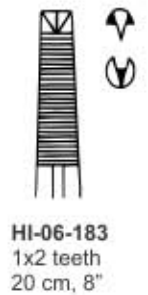

HI-06-183 1x2 teeth 20 cm, 8"



# HAEMOSTATIC FORCEPS

Arterienklemmen  
Pinces Hemostatiques

Pinzas Hemostaticas  
Pinze Emostatiche



Parametrium Haemostatic Forceps

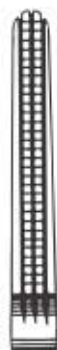

HI-06-184  
21 cm, 8 1/4"  
Straight



HI-06-185  
21 cm, 8 1/4"  
25° Angled



HI-06-186  
21 cm, 8 1/4"  
45° Angled



HI-06-187  
21 cm, 8 1/4"  
90° Angled



HI-06-188  
24 cm, 9 1/2"  
Straight



HI-06-189  
24 cm, 9 1/2"  
25° Angled



HI-06-190  
24 cm, 9 1/2"  
45° Angled



HI-06-191  
24 cm, 9 1/2"  
90° Angled



Bozemann Haemostatic Forceps



HI-06-192  
26 cm, 10 1/4"  
Curved, Serrated



Bozemann Haemostatic Forceps



HI-06-193  
26 cm, 10 1/4"  
Straight



Westermark Haemostatic Forceps

HI-06-194  
23 cm, 9"  
Straight

# HAEMOSTATIC FORCEPS



Arterienklemmen  
Pincas Hemostatiquas

Pinzas Hemostaticas  
Pinze Emostatiche



**HI-06-195**  
1x2 teeth  
21.5 cm, 8 1/2"  
Straight

**Phaneuf Haemostatic Tissue Forceps**



**HI-06-196**  
1x2 teeth  
21.5 cm, 8 1/2"  
Hard Curved



**HI-06-197**  
1x2 teeth  
19.0 cm, 7 1/2"  
Curved

**Long Haemostatic Tissue Forceps**



**HI-06-198**  
1x2 teeth  
19.0 cm, 7 1/2"  
Straight



**HI-06-199**  
1x2 teeth  
14 cm, 5 1/2"

**Baby-Mikulicz Haemostatic Tissue Forceps**



**HI-06-200**  
1x2 teeth  
18.5cm, 7 1/4"

**Mikulicz Haemostatic Tissue Forceps**



Mikulicz Haemostatic Tissue Forceps



Mikulicz Haemostatic Tissue Forceps



Mikulicz Haemostatic Tissue Forceps



Faure Haemostatic Tissue Forceps

# HAEMOSTATIC FORCEPS



Arterienklemmen  
Pincas Hemostatiques

Pinzas Hemostaticas  
Pinze Emostatiche



**HI-06-205**  
1x2 teeth  
23.5cm, 9 1/4"

**Wertheim Haemostatic  
Tissue Forceps**

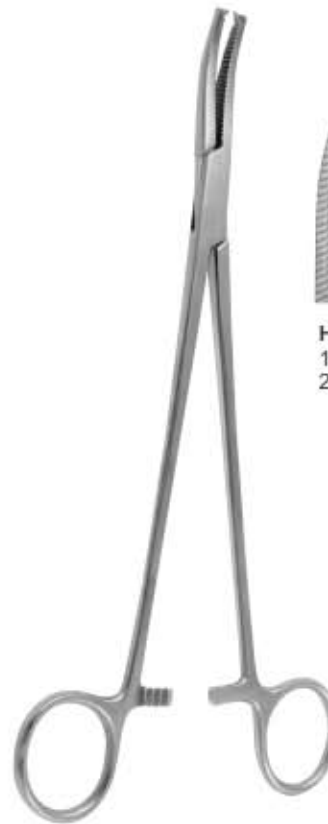

**HI-06-206**  
1x2 teeth  
24.5cm, 9 3/4"

**Wertheim Haemostatic  
Tissue Forceps**



**Heaney Atraumata  
Hysterectomy Forceps**



**HI-06-207**  
22.5cm, 9"  
Straight



**HI-06-208**  
22.5cm, 9"  
25° Angled



**HI-06-209**  
21.5cm, 8 1/2"  
45° Angled



**HI-06-210**  
20.5cm, 8"  
90° Angled



# HAEMOSTATIC FORCEPS

Arterienklemmen  
Pinces Hemostatiques

Pinzas Hemostaticas  
Pinze Emostatiche



Wertheim Parametrium Clamps



**HI-06-211**  
25cm, 10"  
Straight



**HI-06-212**  
24.5cm, 9 3/4"  
25° Angled



**HI-06-213**  
24cm, 9 1/2"  
45° Angled



**HI-06-214**  
22cm, 8 3/4"  
90° Angled



Wertheim Hysterectomy Forceps



**HI-06-215**  
25.5cm, 10"



Wertheim Parametrium Clamp



**HI-06-216**  
26cm, 10 1/4"



**Gemini Mixer Hemostatic Forceps**  
**HI-06-217** 5 1/2"  
**HI-06-218** 7"  
full curve, delicate

# HAEMOSTATIC FORCEPS



Arterienklemmen  
Pinces Hemostatiques

Pinzas Hemostaticas  
Pinze Emostatiche



Dick Haemostatic Forceps

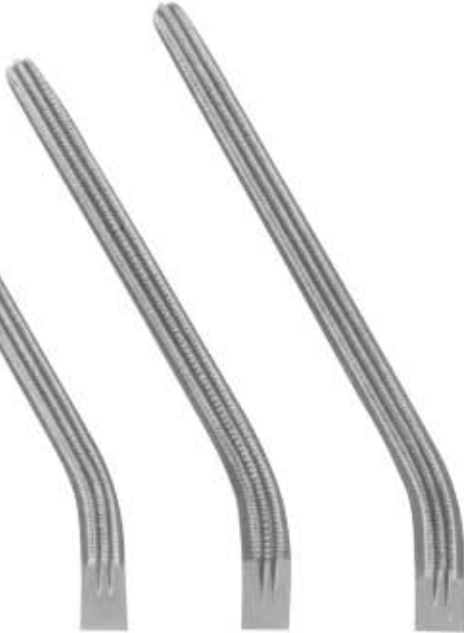

HI-06-219  
25.5cm, 10"

HI-06-220  
26.5cm, 10 1/2"

HI-06-221  
27.5cm, 10 3/4"



HI-06-222  
21.5cm, 8 1/2"

Wertheim-Cullen  
Haemostatic Forceps



Wertheim-Cullen Haemostatic  
Forceps  
23cm, 9"

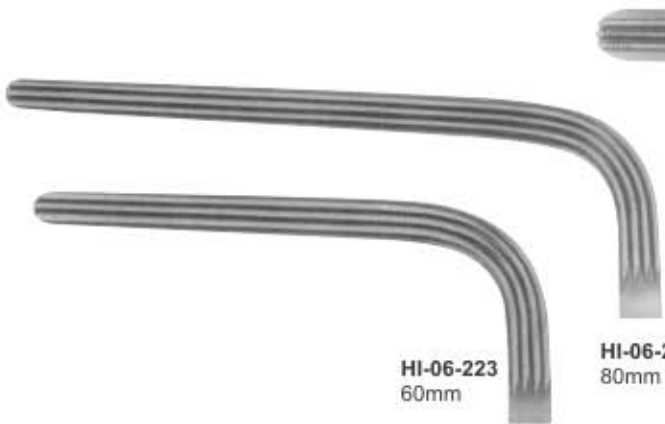

HI-06-223  
60mm

HI-06-224  
80mm



HI-06-225  
25cm, 10"

Wertheim Haemostatic Forceps

## TOWEL FORCEPS

Tuchklemmen | Pincés à champs  
Pinzas de campo | Pinze fissatele



**Jones / Perforating  
Towel Forceps**  
HI-06-226 9 cm, 3 1/2"  
Slight Curve



**Engl. Modell  
Towel Forceps**  
HI-06-227  
9 cm, 3 1/2"



**Schaedel Towel  
Forceps**  
HI-06-228  
9 cm, 3 1/2"



**Thomson-Walker's  
Penile Clamps**  
HI-06-229 9 cm, 3 1/2"  
Cross-Action model.



**Doyen Towel Forceps**  
HI-06-230 18 cm, 7"

## TOWEL FORCEPS

Tuchklemmen | Pincés à champs  
Pinzas de campo | Pinze fissatele



### Backhaus Towel Forceps

HI-06-231 8 cm, 3"  
HI-06-232 11 cm, 4 1/2"  
HI-06-233 13 cm, 5"  
HI-06-234 15 cm, 5 3/4"  
Curved



### Backhaus Clip Towel Forceps

HI-06-235 11 cm, 4 1/2"  
with clip for tubing or cable



### Roeder Towel Forceps

HI-06-236 13 cm, 5"  
HI-06-237 15 cm, 6"  
Curved, Serrated



### Lorna Towel Forceps

HI-06-238 9.0 cm, 3 1/2"  
HI-06-239 11.4 cm, 4 1/2"  
HI-06-240 13.5 cm, 5 1/4"



### Ball & Socket Towel Forceps

HI-06-241 13 cm, 5"  
Non-perforating



### Tohoku Towel Forceps

HI-06-242 10cm, 4"  
HI-06-243 13cm, 5"  
Non-Perforating



## HAEMOSTATIC FORCEPS

Arterienklemmen  
Pincés Hemostatiques

Pinzas Hemostaticas  
Pinze Emostatiche

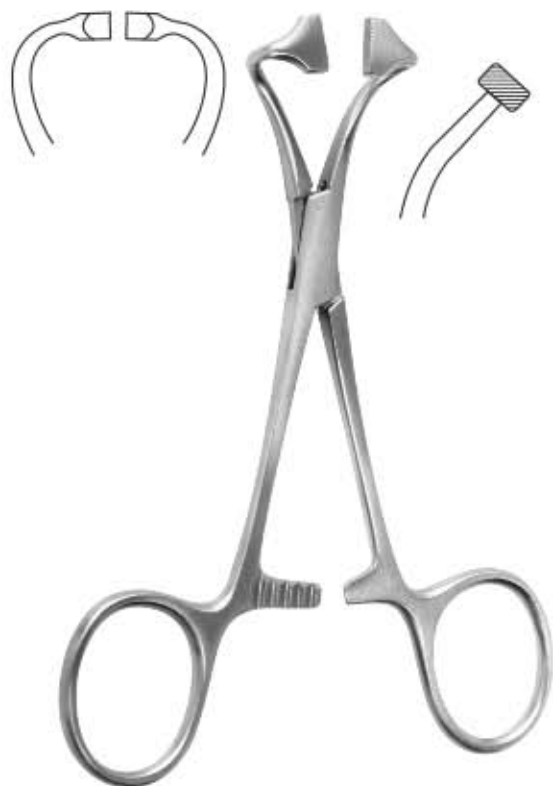

**Non-Perforating Towel Forceps**  
HI-06-244 11 cm, 4 1/2"  
HI-06-245 13 cm, 5"

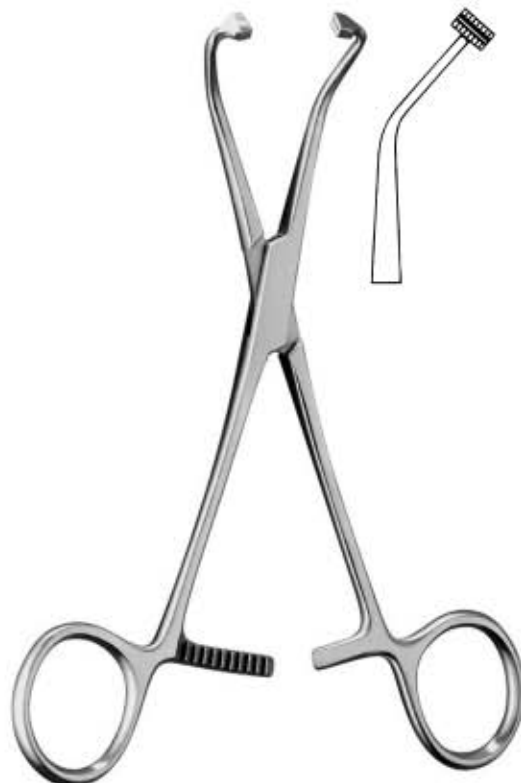

**Peers-Bertman Towel Forceps**  
HI-06-246 14.5 cm, 5 1/4"  
Serrated



**Bernhard Towel Forceps**  
HI-06-247  
16.5 cm, 6 1/2"

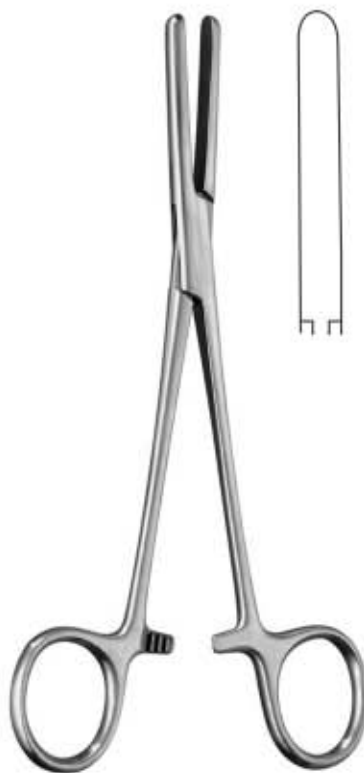

**Presbyterian Tubing Clamp**  
HI-06-248 16.5 cm, 6 1/2"  
HI-06-249 18 cm, 7"  
Straight, Smooth



**Tubing Clamp**  
HI-06-250 18 cm, 7"  
HI-06-251 20 cm, 8"  
Cross Serrated

# HAEMOSTATIC FORCEPS

Arterienklemmen

Pinzas Hemostaticas

Pinces Hemostatiques

Pinze Emostatiche

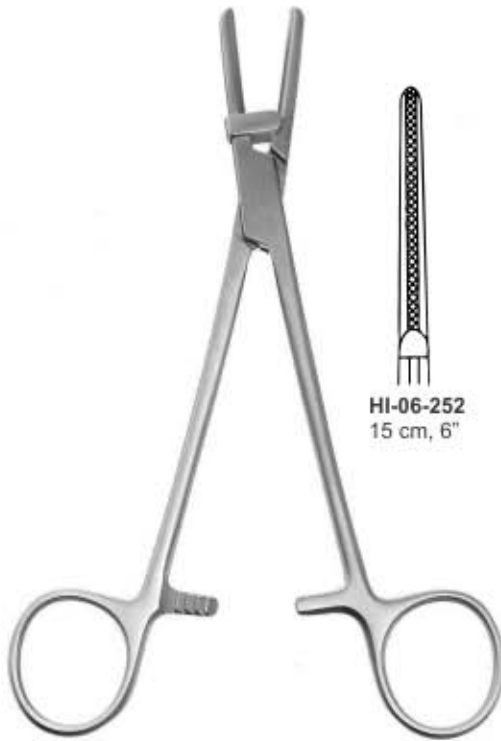

Tubing Clump with Protector,  
Cross Serrated



HI-06-252  
15 cm, 6"



HI-06-253  
18 cm, 7"



HI-06-254  
20 cm, 8"



Klinikum Berlin Tubing Clamp



HI-06-255 14.5 cm, 5 3/4"  
with long ratchet



Fergusson Tubing Clamp



HI-06-256  
16 cm, 6 1/4"



HI-06-257  
20 cm, 8"



HI-06-258  
16 cm, 6 1/4"

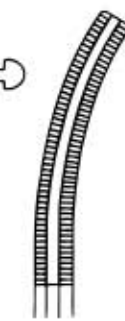

HI-06-259  
20 cm, 8"



Fricke Artery Forceps  
HI-06-260 13cm, 5 1/4"

# HAEMOSTATIC FORCEPS

Arterienklemmen  
Pincas Hemostatiques

Pinzas Hemostaticas  
Pinze Emostatiche



**Tuffier Haemostatic Forceps**  
HI-06-261 13.0 cm, 5"



**Chaput Haemostatic Forceps**  
HI-06-262 13.0 cm, 5"



**Martel Haemostatic Forceps**  
HI-06-263 14.0 cm, 5 1/2"

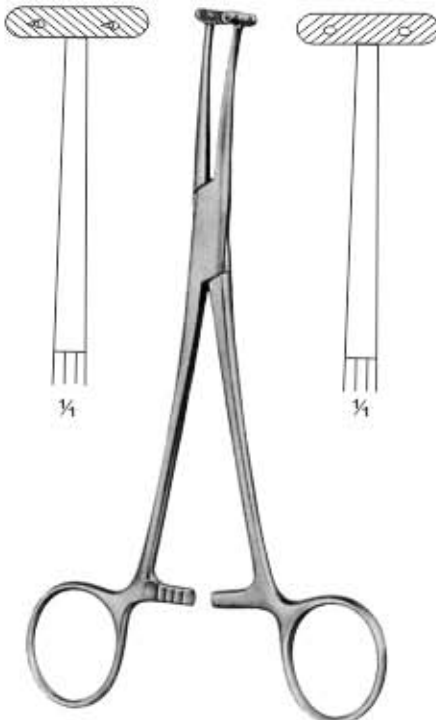

**Willet-Martel Haemostatic Forceps**  
HI-06-264 19.0 cm, 7 1/2"



**Pratt Haemostatic Forceps**  
HI-06-265 15 cm, 4 3/4"



**Pennington / Siezing Haemostatic Forceps**  
HI-06-266 15.5 cm, 6"  
HI-06-267 20 cm, 8"  
Straight

# HAEMOSTATIC FORCEPS



Arterienklemmen  
Pinces Hemostatiques

Pinzas Hemostaticas  
Pinze Emostatiche

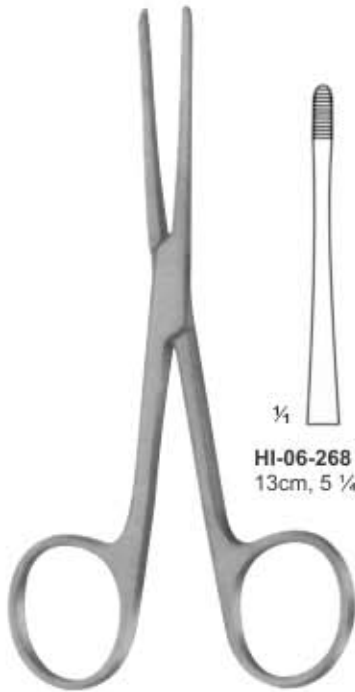

HI-06-268  
13cm, 5 1/4"

HI-06-269  
15.5cm, 6"

HI-06-270  
17.5cm, 7"

Lister Sinus Forceps



HI-06-271  
12.5cm,  
4 3/4"

HI-06-272  
14cm, 5 1/2"

Collin Dressing  
Haemostatic Forceps



HI-06-273  
16.5cm,  
6 1/2"

HI-06-274  
18.5cm,  
7 1/4"

Colling Dressing  
Haemostatic Forceps

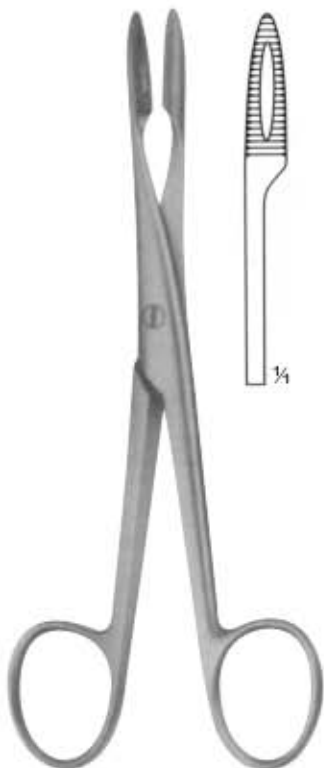

Gross Maier Dressing Forceps  
HI-06-275 14.5cm, 5 3/4" straight  
Without Ratchet



Gross Maier Dressing Forceps  
HI-06-276 14.5cm, 5 3/4" straight  
With Ratchet



Gross Maier Dressing Forceps  
HI-06-277 14.5cm, 5 3/4" curved  
With Ratchet



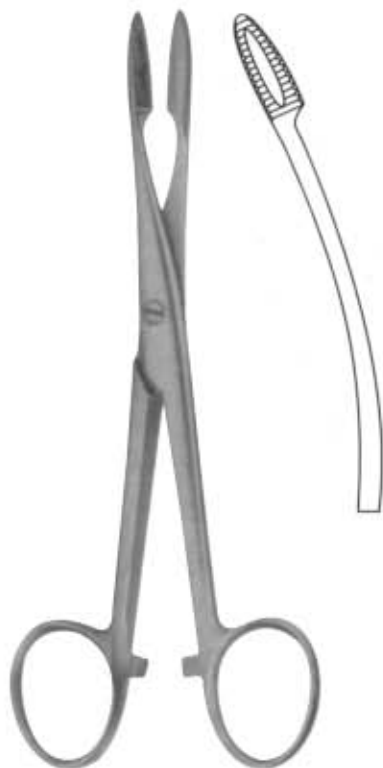

**Gross Maier Dressing Forceps**  
HI-06-278 14.5cm, 5 3/4" curved  
With Ratchet



**Gross Maier Dressing  
Sponge & Dressing Forceps**  
HI-06-279 20.5 cm, 8" straight  
Without Ratchet

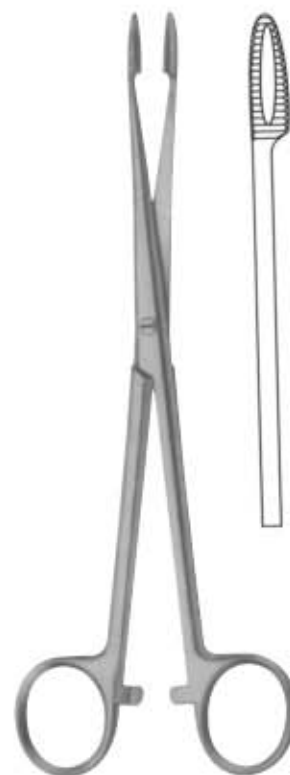

**Gross Maier Dressing  
Sponge & Dressing Forceps**  
HI-06-280 17.8 cm, 7" straight  
With Ratchet

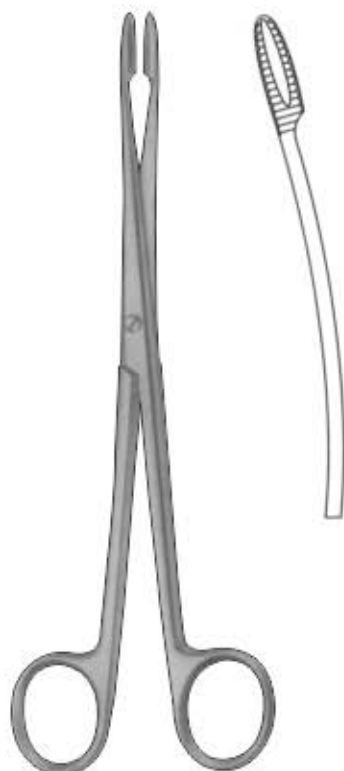

**Gross Maier Dressing  
Sponge & Dressing Forceps**  
HI-06-281 20.5 cm, 8" curved  
Without Ratchet  
(bullet holding forceps)

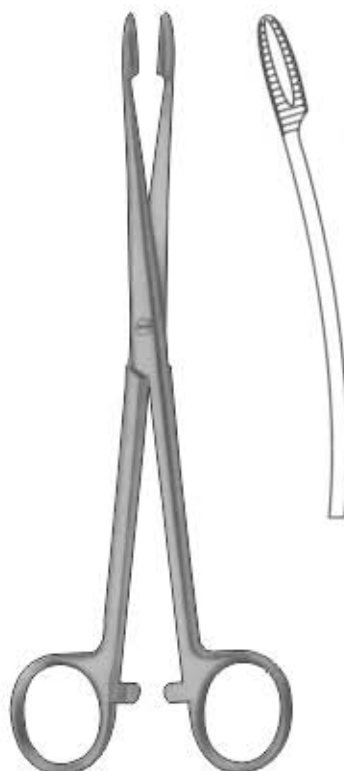

**Gross Maier Dressing  
Sponge & Dressing Forceps**  
HI-06-282 17.8 cm, 7" curved  
With Ratchet

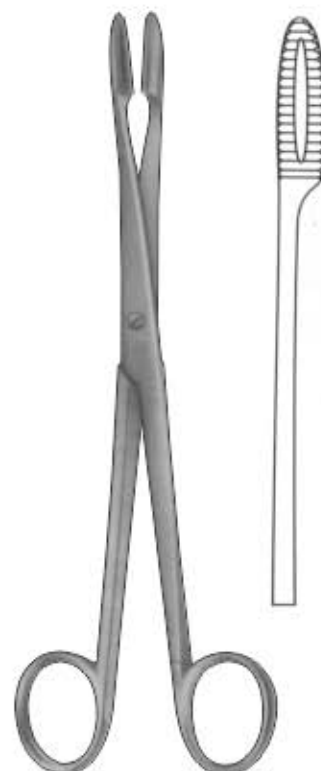

**Gross Maier Dressing Forceps**  
HI-06-283 26.5cm, 10 1/2" straight  
Without Ratchet  
(bullet holding forceps)

# HAEMOSTATIC FORCEPS



Arterienklemmen  
Pincas Hemostatiquas

Pinzas Hemostaticas  
Pinze Emostatiche

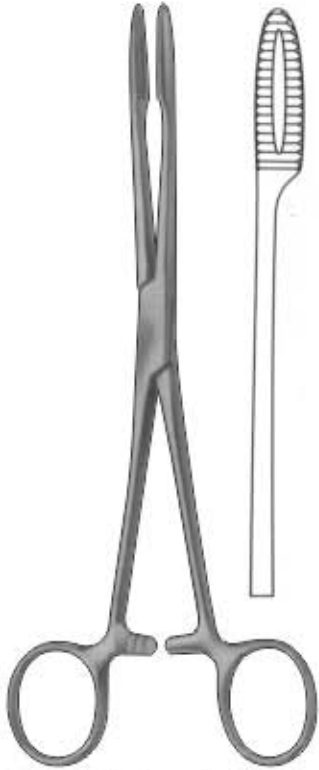

**Gross Maier Dressing Forceps**  
**HI-06-284** 26.5cm, 10 1/2" straight  
With Ratchet  
(bullet holding forceps)

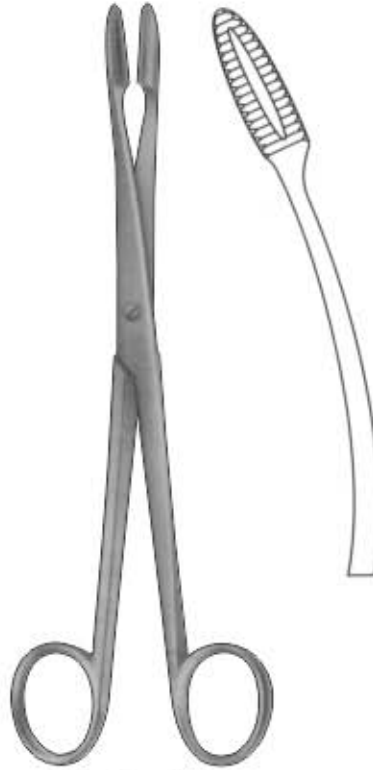

**Gross Maier Dressing Forceps**  
**HI-06-285** 26.5cm, 10 1/2" curved  
Without Ratchet  
(bullet holding forceps)



**Gross Maier Dressing Forceps**  
**HI-06-286** 26.5cm, 10 1/2" curved  
With Ratchet  
(bullet holding forceps)

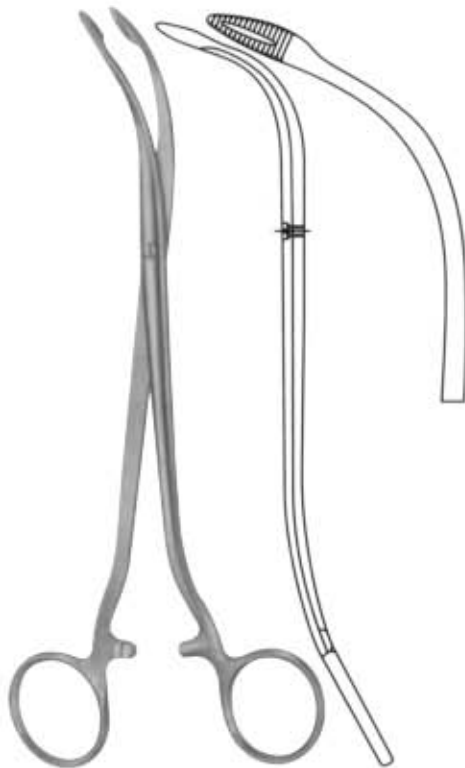

**Duplay Sponge & Dressing Forceps**  
**HI-06-287** 19cm, 7 1/2"  
Slight Curve

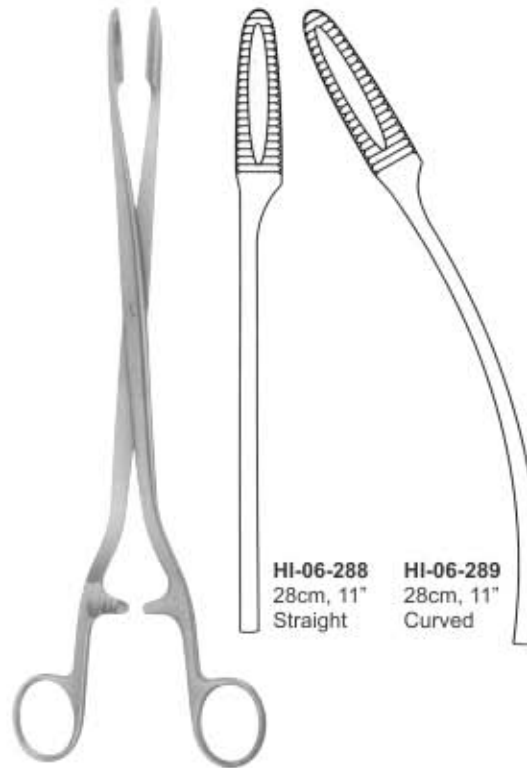

**HI-06-288**  
28cm, 11"  
Straight

**HI-06-289**  
28cm, 11"  
Curved

**Sims-Maier Sponge & Dressing Forceps**



**HI-06-290**  
24cm, 9 1/2"

**Collin Sponge & Dressing Forceps**

# HAEMOSTATIC FORCEPS

Arterienklemmen  
Pinces Hemostatiques

Pinzas Hemostaticas  
Pinze Emostatiche

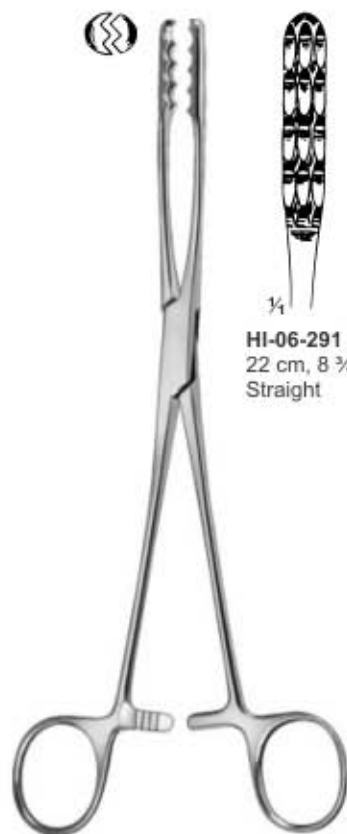

**HI-06-291**  
22 cm, 8 3/4"  
Straight

Ulrich Sponge Forceps

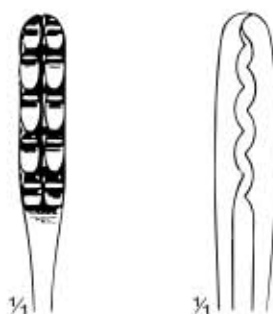

**HI-06-292**  
25 cm, 10"  
**HI-06-293**  
27 cm, 11"  
Straight



**HI-06-294**  
22 cm, 8 3/4"  
Curved

Ulrich Sponge Forceps



**HI-06-295**  
25 cm, 10"  
**HI-06-296**  
27 cm, 11"  
Curved



**HI-06-297**  
22cm, 9 1/4"  
Straight

Aesculap Sponge &  
Dressing Forceps



**HI-06-298**  
22cm, 9 1/4"  
Curved



**HI-06-299**  
24 cm, 9 1/2"  
Straight

Fletcher Sponge Forceps



**HI-06-300**  
24 cm, 9 1/2"  
Slight Curve

Fletcher Sponge Forceps



# HAEMOSTATIC FORCEPS



Arterienklemmen  
Pincas Hemostatiques

Pinzas Hemostaticas  
Pinze Emostatiche



1/4  
**HI-06-301**  
25 cm, 10"  
Straight

Pelkmann Sponge Forceps



1/4  
**HI-06-302**  
25 cm, 10"  
Curved

Pelkmann Sponge Forceps

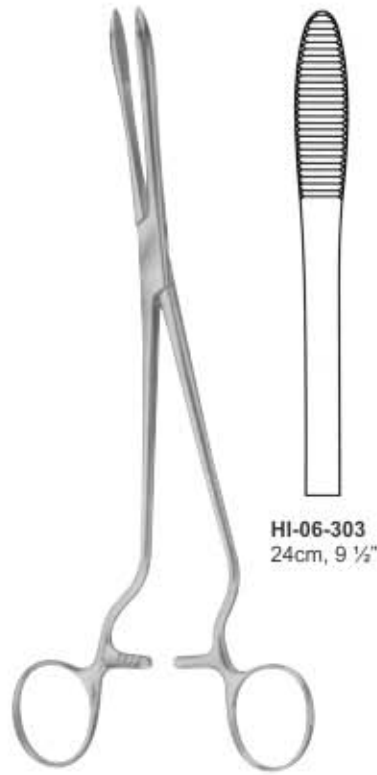

**HI-06-303**  
24cm, 9 1/2"

Cheron Forceps  
Handles Laterally  
Angled



1/4  
**HI-06-304**  
20.5 cm, 8"  
Straight

Duplay Sponge Forceps

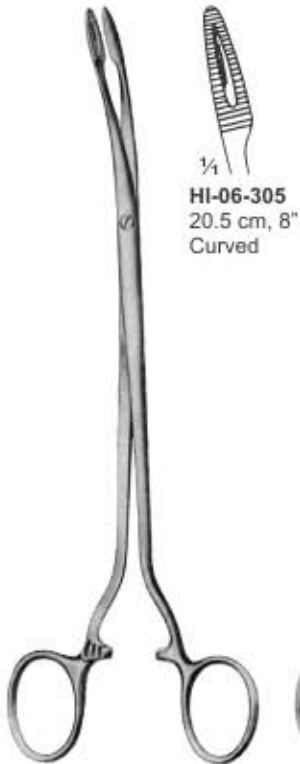

1/4  
**HI-06-305**  
20.5 cm, 8"  
Curved

Duplay Sponge Forceps



**Heywood Smith  
Sponge Forceps**  
**HI-06-306** 25 cm, 10"



**HI-06-307**  
21cm, 8 1/4"

**Emmet Sponge &  
Dressing Forceps**

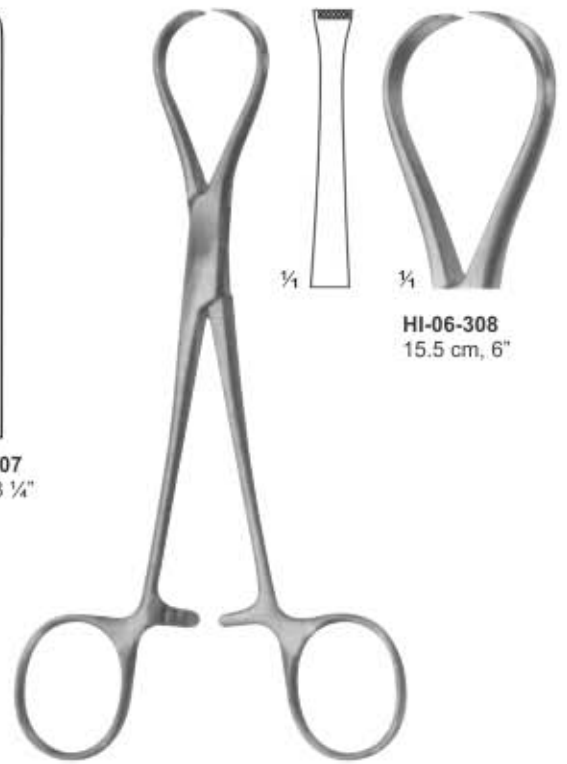

1/4  
**HI-06-308**  
15.5 cm, 6"

**Tendon Seizing Forceps**





**Herz Tendon Seizing Forceps**



**HI-06-309**  
15.5 cm, 6"  
coarse serration



**HI-06-310**  
15.5 cm, 6"  
fine serrations

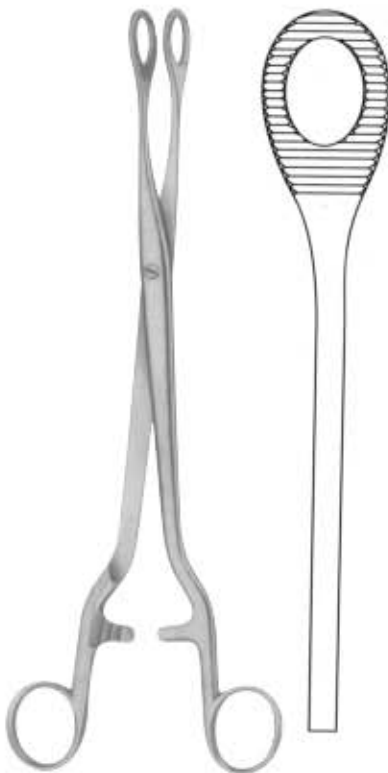

**Noto Sponge &  
Dressing Forceps**  
HI-06-311 28cm, 11"



**Kelly Sponge &  
Dressing Forceps**



**HI-06-312**  
32cm, 12 1/2"  
Curved



**HI-06-313**  
32cm, 12 1/2"  
Straight

# HAEMOSTATIC FORCEPS



Arterienklemmen  
Pincas Hemostatiques

Pinzas Hemostaticas  
Pinze Emostatiche



**Foerster-Ballenger Sponge Forceps**  
& (bullet holding forceps)



**HI-06-314** 18cm, 7"  
**HI-06-315** 20.3cm, 8"  
**HI-06-316** 24.1cm, 9.5"  
Straight Smooth



**HI-06-317** 18cm, 7"  
**HI-06-318** 20.3cm, 8"  
**HI-06-319** 24.1cm, 9.5"  
Straight Serrated



**HI-06-320** 18cm, 7"  
**HI-06-321** 20.3cm, 8"  
**HI-06-322** 24.4cm, 9.5"  
Curved Smooth

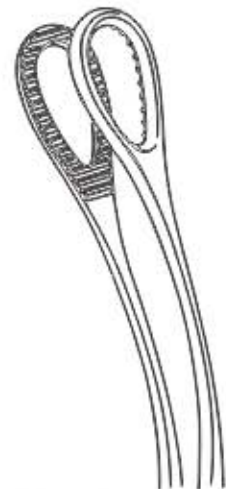

**HI-06-323** 18cm, 7"  
**HI-06-324** 20.3cm, 8"  
**HI-06-325** 24.1cm, 9.5"  
Curved Serrated

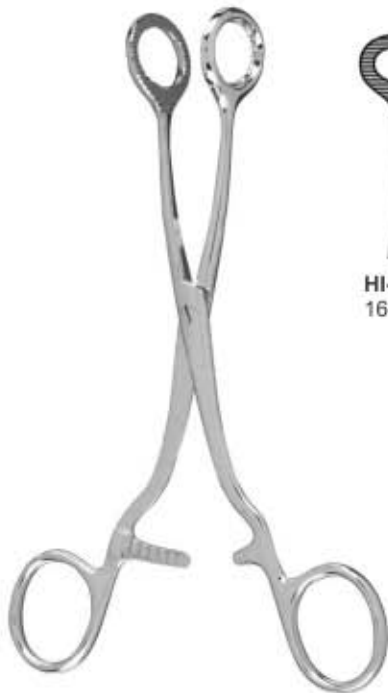

**Collin Sponge & Dressing Forceps**



**HI-06-326**  
16cm, 6 1/4"



**HI-06-327**  
16cm, 6 1/4"



**HI-06-328**  
17cm, 6 3/4"



**Heywood-Smith Sponge & Dressing Forceps**  
**HI-06-329** 20cm, 8"

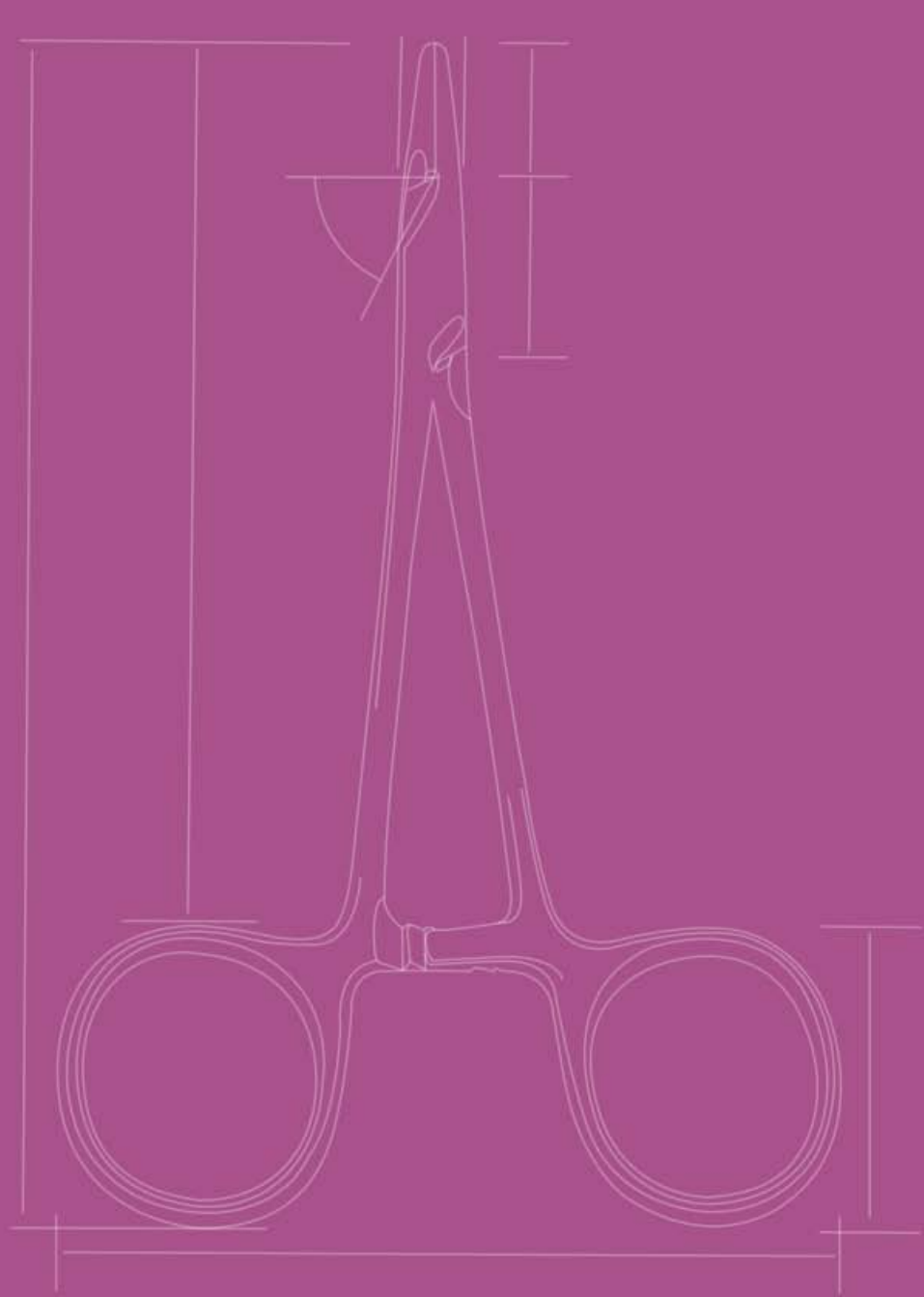

**HOMEDICA**  
INTERNATIONAL