

Surgical Instruments Catalogue

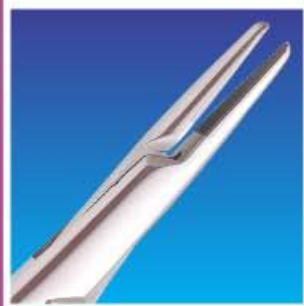

HOMEDICA
INTERNATIONAL

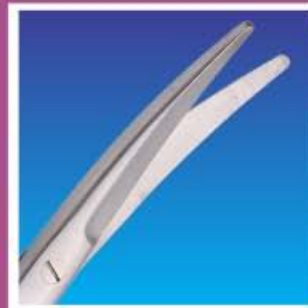

HOMEDICA INTERNATIONAL

Homedica feels great honor introducing itself to be one of the leading manufacturing company of surgical & dental instruments. Professional always prefer Homedica instruments, which is our pride.

Our all instruments are manufactured by the high quality stainless steel made on our requirements, every instrument is hand crafted with the highest workmanship available in the industry. Through heat treatment, the instruments are hardened and tempered for proper functioning and long life. All instruments are polished electrolytically and manually for maximum resistance to corrosion and long life. Homedica pays special attention to the needs of doctors, with innovative designs to meet the needs of professionals. The wide assortment of standard patterns and exclusive Homedica designs gives you the most desirable range of surgical and dental instruments.

Over the several years, we have earned the reputation of for maintaining highest quality standards of quality and service. To manufacture instruments that meet with your changing demands is our achievement. Our highly skilled staff of professionals will continue to serve your needs and will try their outmost to uplift the standards which we have set in the past.

With your co-operation and guidance, Homedica will continue serving surgical and dental instruments in future.

Management of Homedica international

BASIC METHODS FOR HANDLING AND CARE OF SURGICAL AND DENTAL INSTRUMENTS

Dear Customers:

We have received some questions concerning staining, pitting or rusting in stainless steel instruments. So, we took great honour and pleasure in guiding our respected customers to eliminate the problems about staining or rusting etc. The points are as follows:-

- 1) Rinse the instruments as soon as possible after use to remove blood and serum.
- 2) Dry the instruments after cleaning or before wrapping and storing, if not so, moisture left can cause rust and corrosion.
- 3) Do not leave instruments in cold sterilization solution for a long period, as the solution may lead the instrument to be corrosive.
- 4) Never use caustic cleaners, use those specified for cleaning surgical instruments.
- 5) Avoid cleaning instruments with steel wool; if want to clean with hand, use detergent soap and a soft brush and finally treat with distilled water.
- 6) You should check your autoclave; Iron, calcium, sodium or copper in water can cause rusting, staining or corrosion.
- 7) Leaving of instruments for a long time in the following solutions can also cause corrosion.
 - i) Phenol or Iodine.
 - ii) Aluminium, Barium or Calcium.
 - iii) Any Acid, Mercury or Potassium solution.
- 8) Try your utmost not to sterilize stainless steel instrument with chrome plated brass instruments, as any break in chrome surface may cause pitting or rusty surface in instruments.
- 9) Muslin wraps should be rinsed sufficiently by the laundry, so that all chlorine bleach may remove, which can cause corrosion or custing during autoclaving.

We hope that by acting on the above instructions, your problems relating to rusting, staining or pitting would abolish and the age of your instrument would increase.

MANAGEMENT

GYNECOLOGY / OBSTETRICS

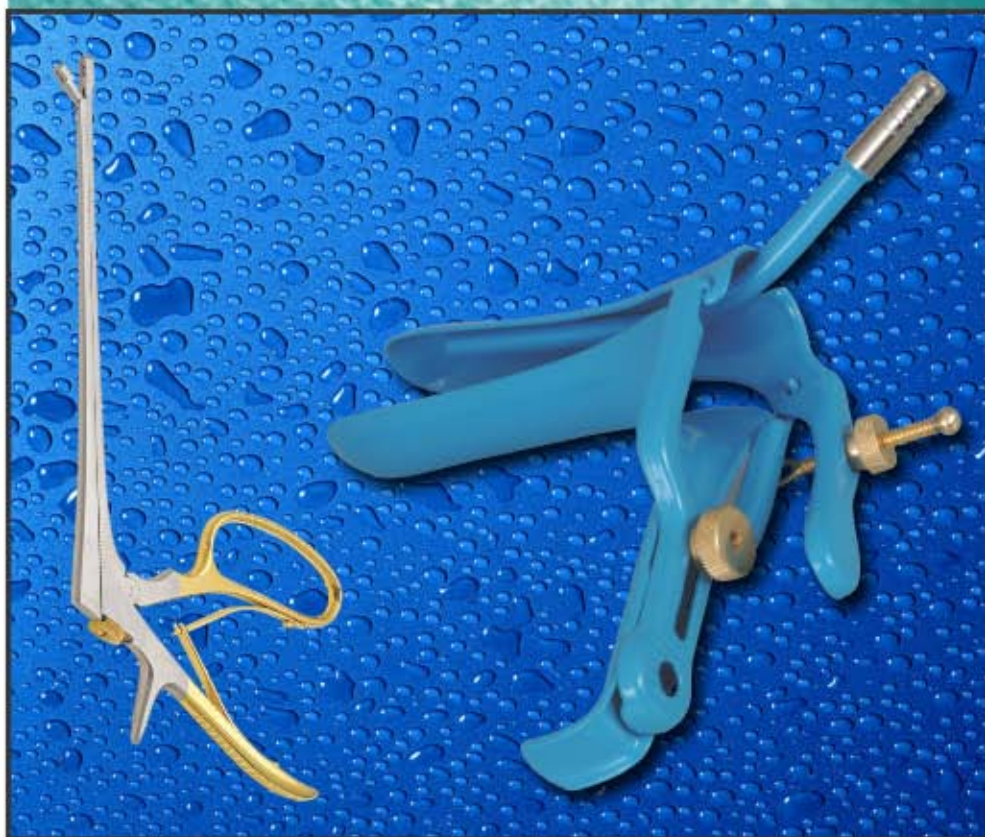

VAGINAL SPECULUM

Scheidenspekula | Espéculos vaginales
Spéculums vaginaux | Specoli vaginali



Cusco vaginal speculum
HI-13-001 75 mm x 32 mm
HI-13-002 85 mm x 35 mm
HI-13-003 100 mm x 35 mm
HI-13-004 75 mm x 17 mm
for virgines



Cusco vaginal speculum
HI-13-005 75 mm x 32 mm
HI-13-006 80 mm x 35 mm
HI-13-007 100 mm x 37 mm



Cusco vaginal speculum
HI-13-008 80 mm x 22 mm
HI-13-009 100 mm x 25 mm
HI-13-010 105 mm x 27 mm
Swiss pattern



Grave vaginal speculum
HI-13-011 75 mm x 20 mm
HI-13-012 95 mm x 35 mm
HI-13-013 115 mm x 35 mm



Collin vaginal speculum
HI-13-014 85 mm x 30 mm
HI-13-015 100 mm x 35 mm
HI-13-016 110 mm x 40 mm



Semm vaginal speculum
HI-13-017 90 mm x 14 / 18 mm
HI-13-018 100 mm x 17 / 20 mm
HI-13-019 110 mm x 25 / 30 mm

VAGINAL SPECULUM

Scheidenspekula | Espéculos vaginales
Spéculums vaginaux | Specoli vaginali



Graves Vaginal Speculum

- HI-13-020 Small 2.2 cm 7/8" Blade
- HI-13-021 Medium 3.5 cm 1 3/8" Blade
- HI-13-022 Large 3.7 cm 1 1/2" Blade



Trelat vaginal speculum

- HI-13-023 85 mm x 30 mm
- HI-13-024 95 mm x 35 mm
- HI-13-025 115 mm x 43 mm



Collin vaginal speculum

- HI-13-025A Virgin
- HI-13-025B Small
- HI-13-025C Medium
- HI-13-025D Large



Pederson vaginal speculum

- HI-13-026 75 mm x 13 mm
- HI-13-027 100 mm x 22 mm
- HI-13-028 120 mm x 25 mm



- ### Graves Vaginal Speculum Leep / Lietz
- HI-13-029 Small
 - HI-13-030 Medium
 - HI-13-031 Large
 - HI-13-032 X-large



- ### Pederson Vaginal Speculum Leep / Lietz
- HI-13-033 Small
 - HI-13-034 Medium
 - HI-13-035 Large
 - HI-13-036 X-Large

VAGINAL SPECULUM

Scheidenspekula | Espéculos vaginales
Spéculums vaginaux | Specoli vaginali



Kristeller Speculum & Retractor
HI-13-037 70 mm x 27 mm
HI-13-038 80 mm x 30 mm
HI-13-039 90 mm x 36 mm
HI-13-040 110 mm x 27 mm
HI-13-041 110 mm x 30 mm
HI-13-042 110 mm x 36 mm



Kristeller Speculum & Retractor
HI-13-043 75 mm x 23 mm
HI-13-044 85 mm x 26 mm
HI-13-045 100 mm x 32 mm
HI-13-046 115 mm x 23 mm
HI-13-047 115 mm x 26 mm
HI-13-048 115 mm x 32 mm

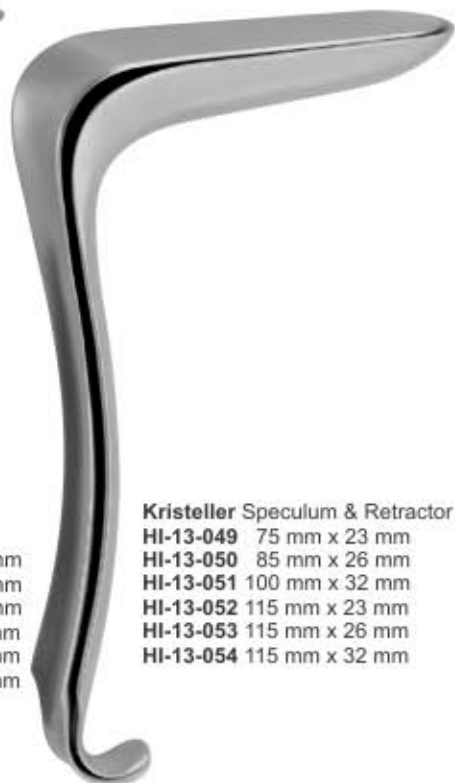

Kristeller Speculum & Retractor
HI-13-049 75 mm x 23 mm
HI-13-050 85 mm x 26 mm
HI-13-051 100 mm x 32 mm
HI-13-052 115 mm x 23 mm
HI-13-053 115 mm x 26 mm
HI-13-054 115 mm x 32 mm



Kristeller speculum & retractor
HI-13-055 105 mm x 18 mm
HI-13-056 105 mm x 21 mm
Speculum tapered, for virgins



Kristeller Speculum & Retractor
HI-13-057 110 mm x 14 mm
HI-13-058 115 mm x 17 mm



Kristeller Speculum & Retractor
HI-13-059 110 mm x 14 mm
HI-13-060 115 mm x 17 mm

VAGINAL SPECULUM

Scheidenspekula | Espéculos vaginales
Spéculums vaginaux | Specoli vaginali



Jackson Speculum & Retractor

HI-13-061 75 mm x 35 mm
HI-13-062 75 mm x 40 mm
HI-13-063 90 mm x 35 mm
HI-13-064 90 mm x 40 mm
HI-13-065 100 mm x 35 mm
HI-13-066 100 mm x 40 mm



Sims Speculum & Retractor

HI-13-067 60 mm x 25 mm / 30 mm
HI-13-068 70 mm x 30 mm / 35 mm
HI-13-069 80 mm x 35 mm / 40 mm



Kallmorgen Speculum & Retractor

HI-13-070 70 mm x 40 mm
HI-13-071 90 mm x 40 mm



Kallmorgen Speculum & Retractor

HI-13-072 70 mm x 33 mm
HI-13-073 90 mm x 33 mm



Kallmorgen Speculum & Retractor

HI-13-074 70 mm x 33 mm
HI-13-075 90 mm x 33 mm

VAGINAL SPECULUM

Scheidenspekula | Espéculos vaginales
Spéculums vaginaux | Specoli vaginali



AUVARD,
speculum & retractor
HI-13-076
80 x 38 mm - 28 mm
1,530 kg
with fixed weight
23 cm, 9"

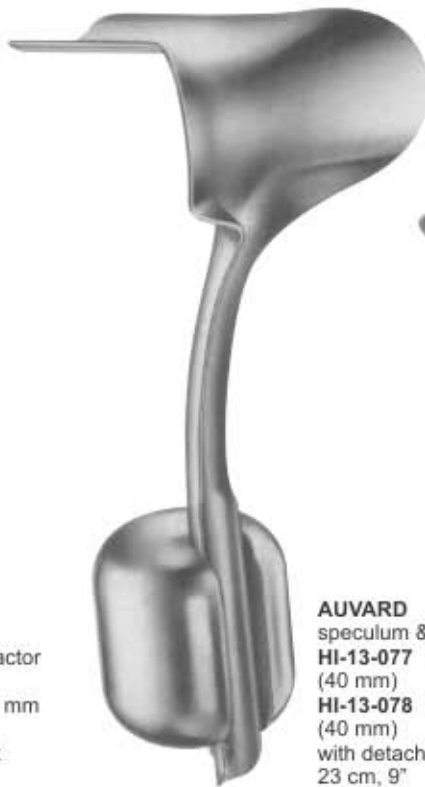

AUVARD
speculum & retractor
HI-13-077 75 x 42 mm
(40 mm)
HI-13-078 105 x 43 mm
(40 mm)
with detachable weight
23 cm, 9"



WEISSBARTH
speculum & retractor
HI-13-079 80 x 28 mm
HI-13-080 85 x 42 mm
21 cm, 8 1/4"



Garrigue Weighted Vaginal Speculum
HI-13-081 4.0 cm x 8.0 cm 1 5/8" x 3 1/8"
Weight 2 lbs



Henrotin Weighted Vaginal Speculum
HI-13-082 3.8 cm x 9.0 cm 1 1/2" x 3 1/2"
Weight 3 lbs.



Landau speculum
29.0 cm 11 1/2"
HI-13-083 100 mm x 28 mm
HI-13-084 100 mm x 38 mm



Breisky speculum
30.0 cm 12"
HI-13-085 130 mm x 20 mm
HI-13-086 130 mm x 25 mm
HI-13-087 130 mm x 30 mm
HI-13-088 130 mm x 35 mm
HI-13-089 130 mm x 40 mm
Vienna pattern



Breisky speculum
30.0 cm 12"
HI-13-090 100 mm x 20 mm
HI-13-091 100 mm x 25 mm
HI-13-092 100 mm x 30 mm
HI-13-093 100 mm x 35 mm
HI-13-094 100 mm x 40 mm



Breisky speculum
35.0 cm 13 3/4"
HI-13-095 160 mm x 40 mm
HI-13-096 180 mm x 40 mm

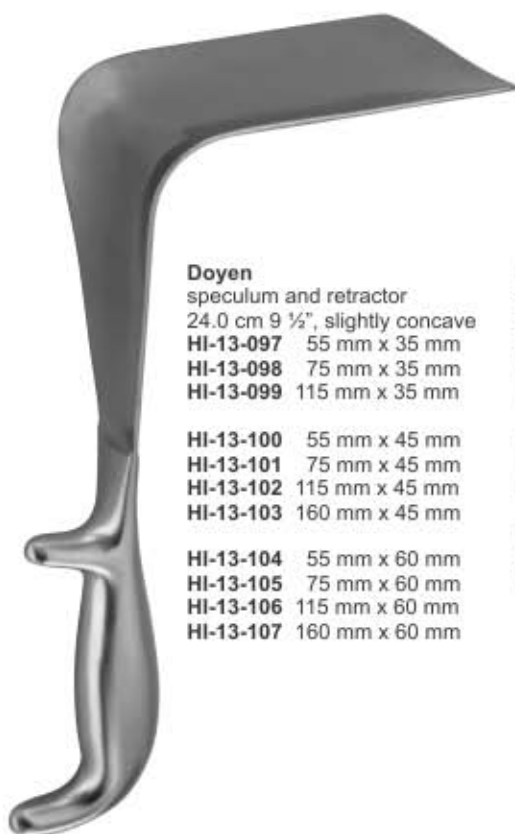

Doyen
speculum and retractor
24.0 cm 9 1/2", slightly concave
HI-13-097 55 mm x 35 mm
HI-13-098 75 mm x 35 mm
HI-13-099 115 mm x 35 mm

HI-13-100 55 mm x 45 mm
HI-13-101 75 mm x 45 mm
HI-13-102 115 mm x 45 mm
HI-13-103 160 mm x 45 mm

HI-13-104 55 mm x 60 mm
HI-13-105 75 mm x 60 mm
HI-13-106 115 mm x 60 mm
HI-13-107 160 mm x 60 mm



Doyen
speculum and retractor
24.0 cm 9 1/2", medium concave
HI-13-108 55 mm x 35 mm
HI-13-109 75 mm x 35 mm
HI-13-110 115 mm x 35 mm

HI-13-111 55 mm x 45 mm
HI-13-112 75 mm x 45 mm
HI-13-113 115 mm x 45 mm

HI-13-114 55 mm x 60 mm
HI-13-115 75 mm x 60 mm
HI-13-116 115 mm x 60 mm

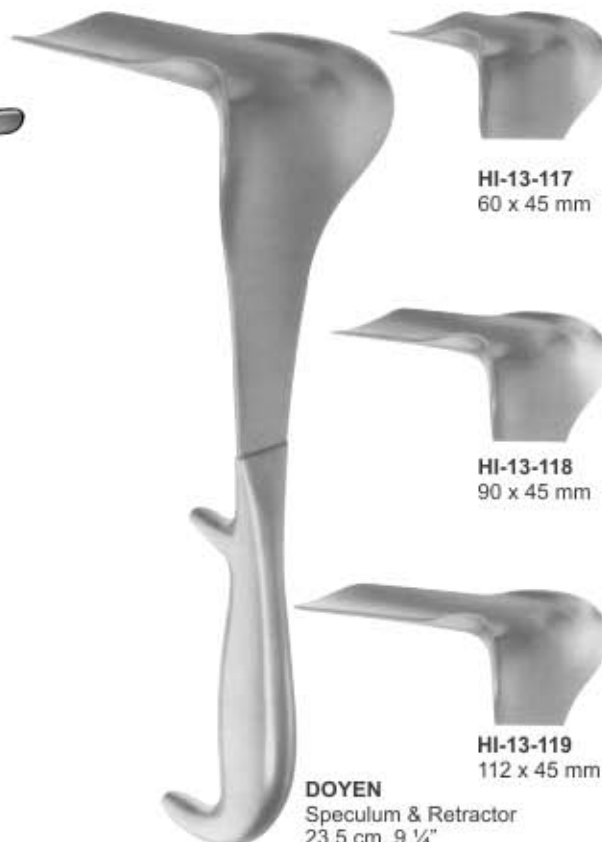

HI-13-117
60 x 45 mm

HI-13-118
90 x 45 mm

HI-13-119
112 x 45 mm

DOYEN
Speculum & Retractor
23.5 cm, 9 1/4"

VAGINAL SPECULUM

Scheidenspekula | Espéculos vaginales
Spéculums vaginaux | Specoli vaginali



**Scherback Speculum
HI-13-120**
Set consisting of:
handle weight 5 blades

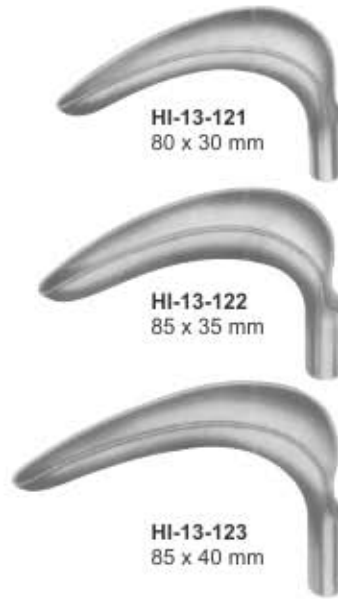

HI-13-121
80 x 30 mm

HI-13-122
85 x 35 mm

HI-13-123
85 x 40 mm



HI-13-124
55 x 40 - 60 mm

HI-13-125
70 x 45 - 70 mm

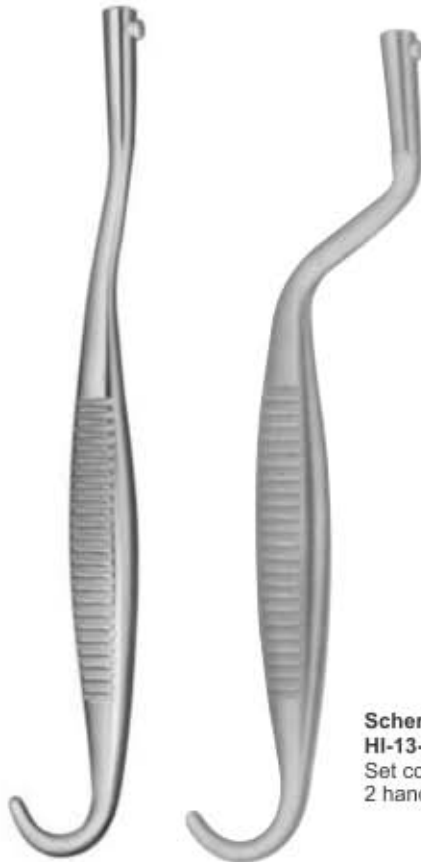

**Scherback Speculum
HI-13-126**
Set consisting of:
2 handle, 8 blades



HI-13-127
80 x 30 mm

HI-13-131
65 x 30 mm

HI-13-128
85 x 33 mm

HI-13-132
75 x 35 mm

HI-13-129
100 x 38 mm

HI-13-133
85 x 35 mm

HI-13-130
110 x 42 mm

HI-13-134
95 x 35 mm

VAGINAL SPECULUM

Scheidenspekula | *Espéculos vaginales*
Spéculums vaginaux | *Specoli vaginali*



**O'Sullivan - O'Connor
Vaginal Retractor**
HI-13-135 Set of 3 Complete



HI-13-136
45 x 17 mm



HI-13-137
90 x 37 mm



HI-13-138
90 x 45 mm



Abdominal Retractor
 HI-13-139 9 cm, 3 ½" wide
 HI-13-140 10 cm, 4" wide
 HI-13-141 11.5 cm, 4 ½" wide



Friedmann Retractor
 HI-13-142
 10 cm, 4"

VAGINAL SPECULUM

Scheidenspekula | Espéculos vaginales
Spéculums vaginaux | Specoli vaginali



**Kogan speculum
HI-13-143**
24 cm, 9 1/2"
with scale-ratchet
and fixation screw



**Kogan speculum
HI-13-144**
24 cm, 9 1/2"



**Kogan - Modif.
speculum**
28 cm, 11"
HI-13-145
x=4 mm y=8mm
HI-13-146
x=2 mm y=4mm



**Lateral Nonconductive
Vaginal Retractor**
HI-13-147 6.3 cm wide



**McGee Lateral
Vaginal Retractor**
With Ratchet Handle
HI-13-148 20cm, 8"

UTERINE SOUNDS

Uterus-Sonden

Histerómetros uterinos

Hystéromètres du col de l'utérus

Isterometri uterini



Sims Uterine Sound
HI-13-149
33 cm, 13"
right, malleable



Sims Uterine Sound
HI-13-150
32.5cm 12 3/4"
Non-graduated



Sims Uterine Sound
HI-13-151
32.5cm 12 3/4"
Graduated in cm



Sims-Special Uterine Sound
HI-13-152 33 cm, 13"



Sims Uterine Sound
schwed. Modell
HI-13-153
26 cm, 10 1/4"



Martin Uterine Sound
HI-13-154 30 cm, 12"



Valleix Uterine Sound
HI-13-155 25 cm, 10"



Mayo Uterine Sound
HI-13-156 33 cm 13"
biegam malleable



Simpson Uterine Sound
HI-13-157 29 cm 11 1/2"
malleable silver-plated



Simpson Uterine Sound
HI-13-158 32.5cm 12 3/4"
Graduated in inches

Uterus-Sonden

Histerómetros uterinos

Hystéromètres du col de l'utérus

Isterometri uterini



Hegar Uterine Dilator
single ended

HI-13-159	1.0mm Ø	HI-13-179	11.5mm Ø	HI-13-199	23.0mm Ø
HI-13-160	1.5mm Ø	HI-13-180	12.0mm Ø	HI-13-200	24.0mm Ø
HI-13-161	2.0mm Ø	HI-13-181	12.5mm Ø	HI-13-201	25.0mm Ø
HI-13-162	2.5mm Ø	HI-13-182	13.0mm Ø	HI-13-202	26.0mm Ø
HI-13-163	3.0mm Ø	HI-13-183	13.5mm Ø	HI-13-203	27.0mm Ø
HI-13-164	3.5mm Ø	HI-13-184	14.0mm Ø	HI-13-204	28.0mm Ø
HI-13-165	4.0mm Ø	HI-13-185	14.5mm Ø	HI-13-205	29.0mm Ø
HI-13-166	4.5mm Ø	HI-13-186	15.0mm Ø	HI-13-206	30.0mm Ø
HI-13-167	5.0mm Ø	HI-13-187	15.5mm Ø		
HI-13-168	6.0mm Ø	HI-13-188	16.0mm Ø		
HI-13-169	6.5mm Ø	HI-13-189	16.5mm Ø		
HI-13-170	7.0mm Ø	HI-13-190	17.0mm Ø		
HI-13-171	7.5mm Ø	HI-13-191	17.5mm Ø		
HI-13-172	8.0mm Ø	HI-13-192	18.0mm Ø		
HI-13-173	8.5mm Ø	HI-13-193	18.5mm Ø		
HI-13-174	9.0mm Ø	HI-13-194	19.0mm Ø		
HI-13-175	9.5mm Ø	HI-13-195	19.5mm Ø		
HI-13-176	10.0mm Ø	HI-13-196	20.0mm Ø		
HI-13-177	10.5mm Ø	HI-13-197	21.0mm Ø		
HI-13-178	11.0mm Ø	HI-13-198	22.0mm Ø		

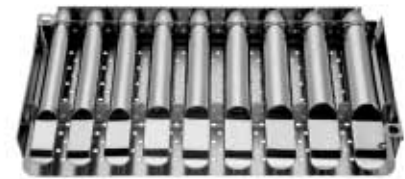

Hegar Uterine Dilator
single ended
HI-13-207 4 mm - 17 mm Ø
8 Pieces per set
HI-13-208 1 mm - 26 mm Ø
24 Pieces per set



Hegar Uterine Dilator
single ended
HI-13-209 4 mm - 17 mm Ø
24 pieces per set



Hegar uterine dilator

HI-13-210	1 / 2 mm Ø
HI-13-211	3 / 4 mm Ø
HI-13-212	5 / 6 mm Ø
HI-13-213	7 / 8 mm Ø
HI-13-214	9 / 10 mm Ø
HI-13-215	11 / 12 mm Ø
HI-13-216	13 / 14 mm Ø
HI-13-217	15 / 16 mm Ø
HI-13-218	17 / 18 mm Ø
HI-13-219	19 / 20 mm Ø
HI-13-220	21 / 22 mm Ø
HI-13-221	23 / 24 mm Ø
HI-13-222	25 / 26 mm Ø

double ended



Hegar uterine dilator
HI-13-223 3 / 4 mm - 17 / 18 mm Ø
8 Pieces per set
HI-13-224 1 / 2 mm - 25 / 26 mm Ø
14 Pieces per set



Hegar Uterine Dilator, Double-ended

- HI-13-225 3mm & 4mm, 7 7/8" (20cm)
- HI-13-226 5mm & 6mm, 7 7/8" (20cm)
- HI-13-227 7mm & 8mm, 7 7/8" (20cm)
- HI-13-228 9mm & 10mm, 7 7/8" (20cm)
- HI-13-229 11mm & 12mm, 7 7/8" (20cm)
- HI-13-230 13mm & 14mm, 7 7/8" (20cm)
- HI-13-231 15mm & 16mm, 7 7/8" (20cm)
- HI-13-232 17mm & 18mm, 7 7/8" (20cm)



Hegar Uterine Dilators 8 Set W/Roll

- HI-13-233 Complete Set
- Curved, Delicate, 3mm to 18mm, Curved



Hank Dilator

- HI-13-234 Fig. 19 / 10 4.5 / 5.0 mm Ø
- HI-13-235 Fig. 11 / 12 5.5 / 6.0 mm Ø
- HI-13-236 Fig. 13 / 14 6.5 / 7.0 mm Ø
- HI-13-237 Fig. 15 / 16 7.5 / 8.0 mm Ø
- HI-13-238 Fig. 17 / 18 8.5 / 9.0 mm Ø
- HI-13-239 Fig. 19 / 20 9.5 / 10.0 mm Ø



Hank Dilator set

- HI-13-240 Fig. 4.5 / 5 mm - 9.5 / 10.0 mm Ø
- 6 Pieces per set

PARAMETRIUM FORCEPS, HYSTERECTOMY FORCEPS



Parametriumklemmen, Hysterektomieklemmen | Pinzas parametrium, Pinzas-clamps para histerectomia
 Pincas parametrium, Pincas à hystérectomie | Pinze parametrium, Pinze per isterectomia

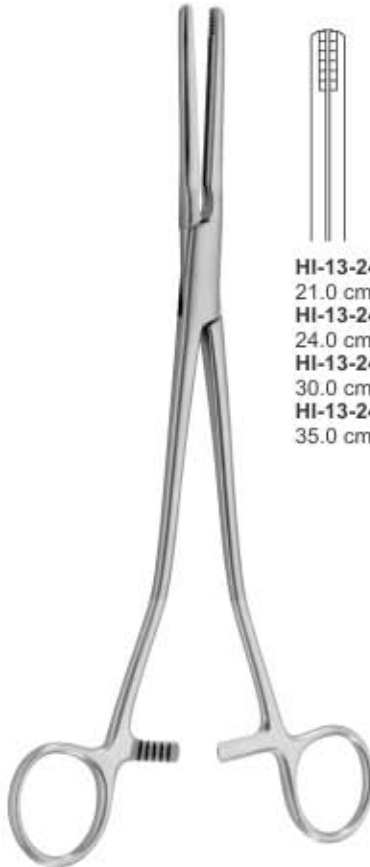

**Parametrium
Hysterectomy
Forceps**

HI-13-241 21.0 cm 8 1/4"	HI-13-245 21.0 cm 8 1/4"	HI-13-249 21.0 cm 8 1/4"	HI-13-253 21.0 cm 8 1/4"	HI-13-257 21.0 cm 8 1/4"
HI-13-242 24.0 cm 9 1/2"	HI-13-246 24.0 cm 9 1/2"	HI-13-250 24.0 cm 9 1/2"	HI-13-254 24.0 cm 9 1/2"	HI-13-258 24.0 cm 9 1/2"
HI-13-243 30.0 cm 12"	HI-13-247 30.0 cm 12"	HI-13-251 30.0 cm 12"	HI-13-255 30.0 cm 12"	HI-13-259 30.0 cm 12"
HI-13-244 35.0 cm 13 3/4"	HI-13-248 35.0 cm 13 3/4"	HI-13-252 35.0 cm 13 3/4"	HI-13-256 35.0 cm 13 3/4"	HI-13-260 35.0 cm 13 3/4" S-curved



**Rogers Parametrium
Hysterectomy Forceps**

HI-13-261 Fig. 1 22.0 cm 8 3/4"	HI-13-262 Fig. 2 21.5 cm 8 1/2"	HI-13-263 Fig. 3 21.0 cm 8 1/4"	HI-13-264 Fig. 4 20.5 cm 8"
HI-13-265 Fig. 1 25.0 cm 9 3/4"	HI-13-266 Fig. 2 25.0 cm 9 3/4"	HI-13-267 Fig. 3 24.5 cm 9 1/2"	HI-13-268 Fig. 4 23.0 cm 9"



Stauder - Moore
Tenaculum Forceps
HI-13-269
17.0 cm 6 3/4"



Barrett
Tenaculum Forceps
HI-13-270
18.0 cm 7"

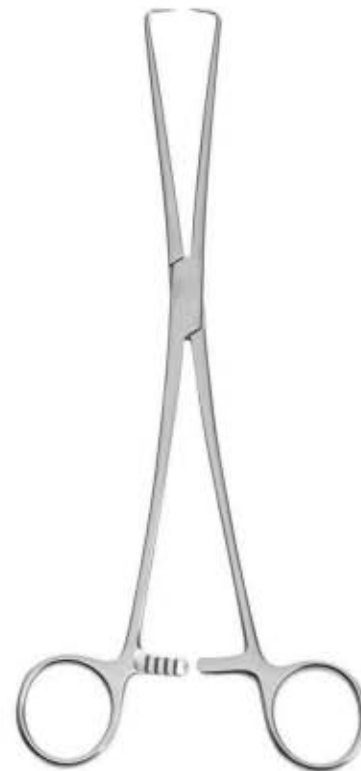

Schroeder-Braun
Tenaculum Forceps
HI-13-271
25.0 cm 9 3/4"



Skene
Tenaculum Forceps
HI-13-272
24.0 cm 9 1/2"



Pozzi Tenaculum Forceps
HI-13-273 25.5 cm 10"



Schroeder Tenaculum Forceps
HI-13-274 25.0 cm 9 3/4"

TENACULUM FORCEPS



Hakenzangen

Pinzas para coger el cuello del útero

Pinces pour l'abaissement du col de l'utérus

Pinze per abbassare il collo dell'utero



**Schroeder Vulsellum
Tenaculum Forceps**



HI-13-275
24.0 cm 9 1/2"



HI-13-276
24.0 cm 9 1/2"



**Duplay Tenaculum
Forceps**
HI-13-277 28.0 cm 11"



Iowa Tenaculum Forceps
HI-13-278 26.0 cm 10 1/4"



Beacham Amniotome
HI-13-279 26.0 cm 10 1/4"



Pratt Tenaculum Forceps
HI-13-280
26.0 cm 10 1/4"



Czerny Tenaculum Forceps
HI-13-281
20.5 cm 8"

Hakenzangen

Pinzas para coger el cuello del útero

Pinces pour l'abaissement du col de l'utérus

Pinze per abbassare il collo dell'utero



Museux Tenaculum Forceps

HI-13-282 8 mm	HI-13-285 8 mm
HI-13-283 6 mm	HI-13-286 6 mm
HI-13-284 10 mm	HI-13-287 10 mm
24.0 cm 9 1/2"	24.0 cm 9 1/2"



Jacobs Uterine Vulsellum Forceps



HI-13-288 21.0 cm 8 1/4"
HI-13-289 21.0 cm 8 1/4"



Teale Tenaculum Forceps
HI-13-290
 23.0 cm 9"



Gellhorn Biopsy Forceps
HI-13-291
 23.0 cm 9"



Thoms-Gaylor Biopsy Forceps
HI-13-292 22.0 cm 8 3/4"
HI-13-293 24.0 cm 9 1/2"

CERVICAL BIOPSY AND SPECIMEN FORCEPS



Probeexzisionszangen

Pinzas saca-bocados para biopsia

Pinces emporte-pièces à biopsie

Pinze taglianti per biopsia



Schubert Biopsy Forceps
 HI-13-294 21.0 cm 8 1/2"
 HI-13-295 28.0 cm 11"



Faure Uterine Biopsy Forceps
 HI-13-296 21.0 cm 8 1/2"



Schubert Biopsy Forceps
 HI-13-297
 26.0 cm 10 1/4"



Van Doren Biopsy Forceps
 HI-13-298
 24.0 cm 9 1/2"



Schumacher Biopsy Forceps

Fig. 1
 HI-13-299
 24.0 cm 9 1/2"

Fig. 2
 HI-13-300
 24.0 cm 9 1/2"

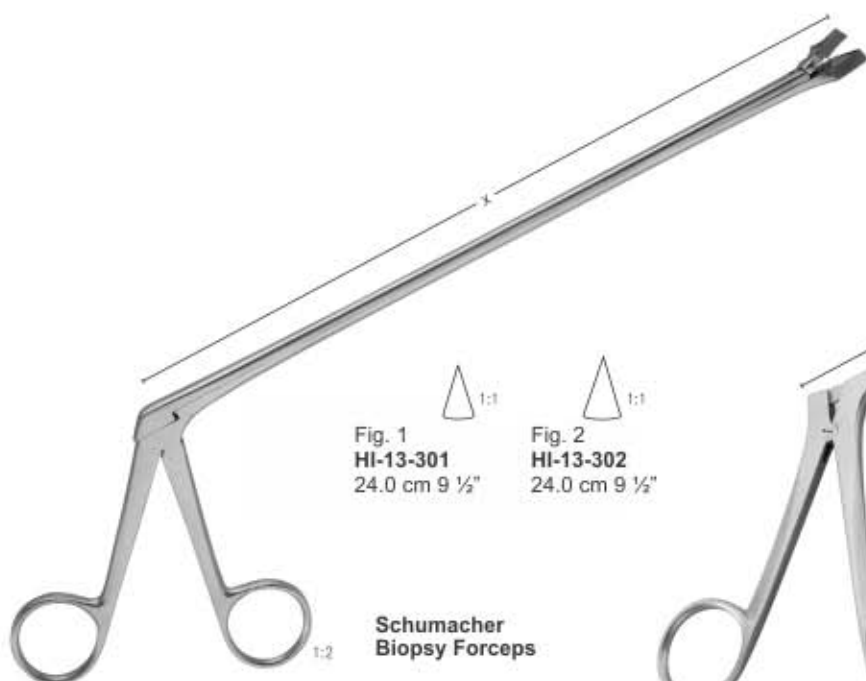

Fig. 1
HI-13-301
24.0 cm 9 1/2"

Schumacher
Biopsy Forceps

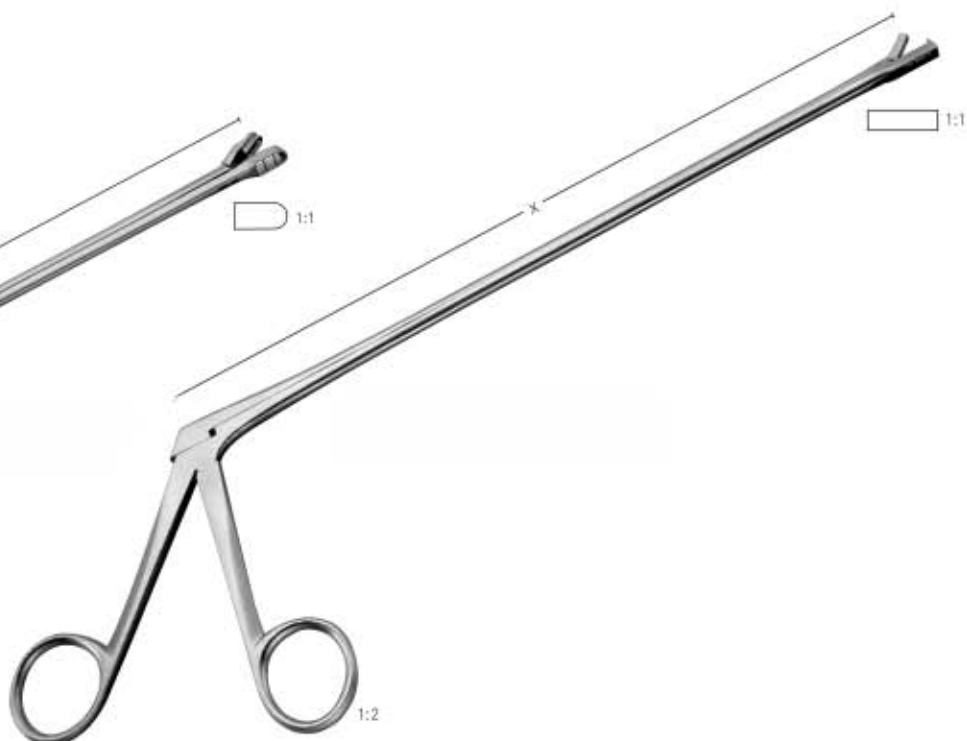

Fig. 2
HI-13-302
24.0 cm 9 1/2"

Berger
Biopsy and Specimen Forceps
HI-13-303
x = 200 mm - 8"



Eppendorfer
Biopsy and Specimen Forceps
HI-13-304
x = 200 mm - 8"



Kevorkian
Biopsy and Specimen Forceps
HI-13-305
x = 245 mm - 9 3/4"

CERVICAL BIOPSY AND SPECIMEN FORCEPS

Probeexzisionszangen

Pinzas saca-bocados para biopsia

Pinces emporte-pièces à biopsie

Pinze taglianti per biopsia

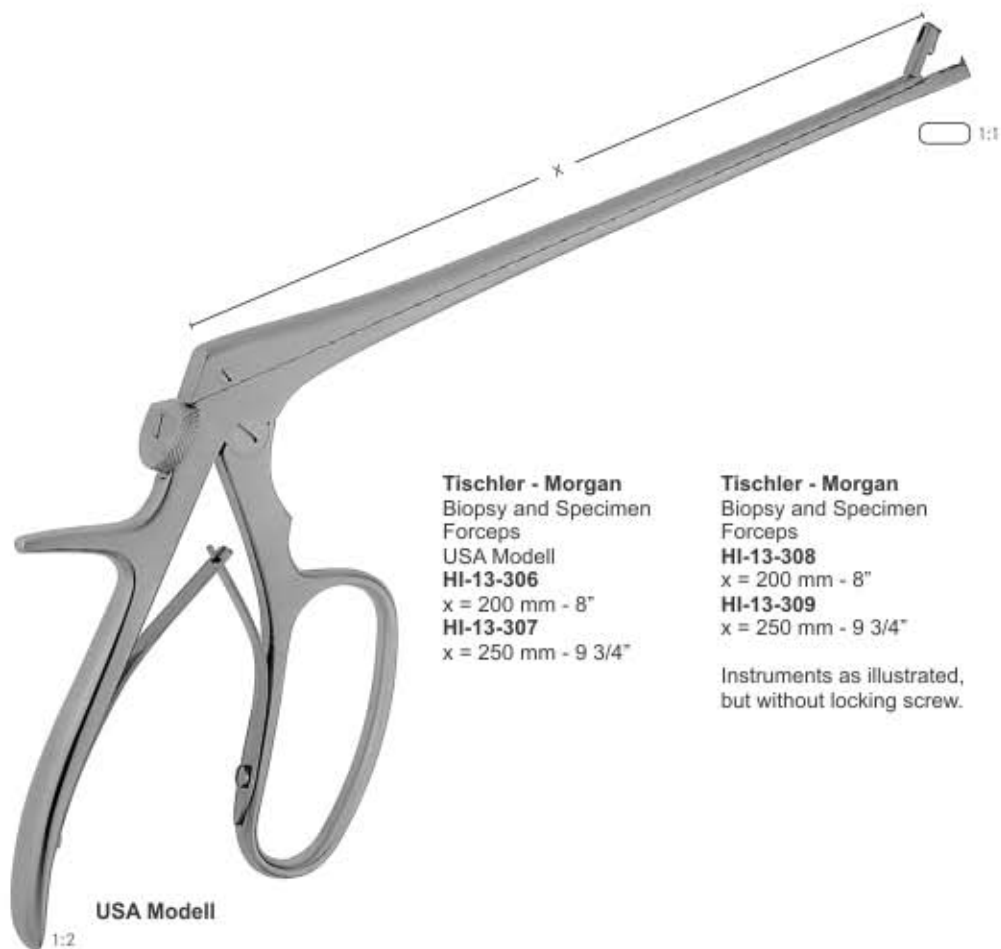

Tischler - Morgan
Biopsy and Specimen
Forceps
USA Modell
HI-13-306
x = 200 mm - 8"
HI-13-307
x = 250 mm - 9 3/4"

Tischler - Morgan
Biopsy and Specimen
Forceps
HI-13-308
x = 200 mm - 8"
HI-13-309
x = 250 mm - 9 3/4"

Instruments as illustrated,
but without locking screw.

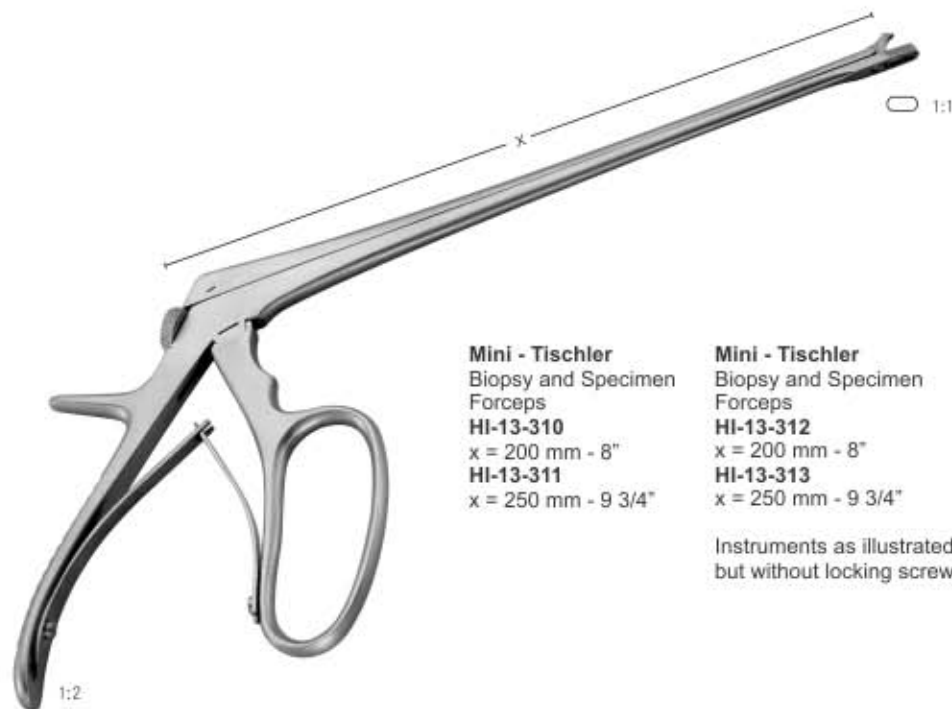

Mini - Tischler
Biopsy and Specimen
Forceps
HI-13-310
x = 200 mm - 8"
HI-13-311
x = 250 mm - 9 3/4"

Mini - Tischler
Biopsy and Specimen
Forceps
HI-13-312
x = 200 mm - 8"
HI-13-313
x = 250 mm - 9 3/4"

Instruments as illustrated,
but without locking screw.



**Segond
Myoma Knife
Fistula Hook**
HI-13-314
27.0 cm 10 3/4"

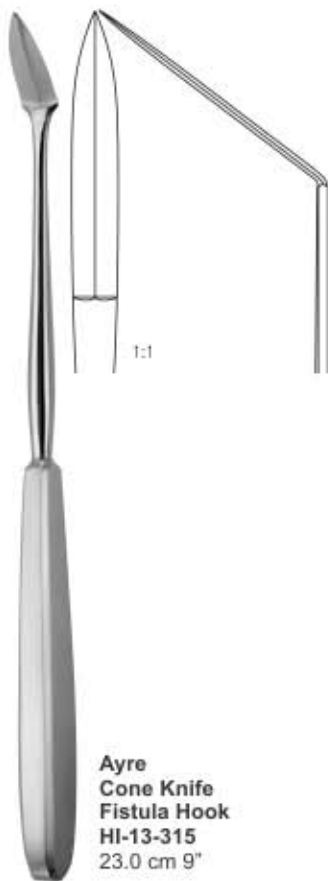

**Ayre
Cone Knife
Fistula Hook**
HI-13-315
23.0 cm 9"



**Doyen
Myoma Screw
And Fistula Hook**
HI-13-316
17.0 cm 6 3/4"



**Fig. 1
HI-13-317**
22.0 cm 8 3/4"



**Simon
Fistula Hook,
One Prong**



**Fig. 2
HI-13-318**
22.0 cm 8 3/4"



**Simon
Fistula Hook,
Two Prong**



**Emmet
Fistula Hook**



**Fig. 1
HI-13-319**
22.0 cm 8 3/4"



**Fig. 2
HI-13-320**
22.0 cm 8 3/4"



**Fig. 3
HI-13-321**
22.0 cm 8 3/4"



**Fig. 4
HI-13-322**
22.0 cm 8 3/4"



**Fig. 5
HI-13-323**
22.0 cm 8 3/4"

BIOPSY CURETTES, ASPIRATING CURETTES



Biopsieküretten, Absaugküretten

Curetas de aspiración

Curettes pour biopsie, Curettes d'aspiration

Curette per aspirazione



Uni - Randall
aspirating curette
HI-13-324 4 mm Ø
24.0 cm 9 1/2"



Novak
aspirating curette
HI-13-325 4 mm Ø
23.0 cm 9"

Mini - Novak
aspirating curette
23.5 cm 9 1/4"
HI-13-326 1 mm Ø
HI-13-327 2 mm Ø
HI-13-328 3 mm Ø

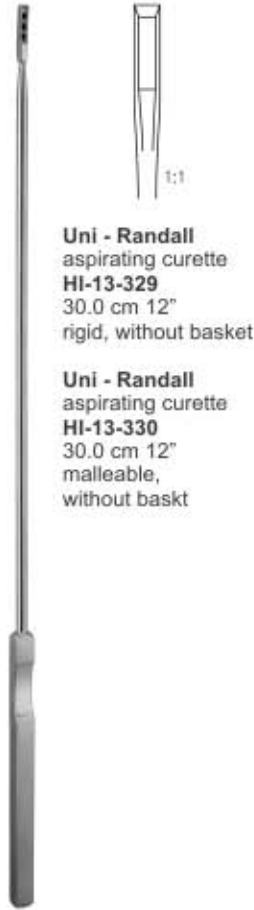

Uni - Randall
aspirating curette
HI-13-329
30.0 cm 12"
rigid, without basket

Uni - Randall
aspirating curette
HI-13-330
30.0 cm 12"
malleable,
without basket

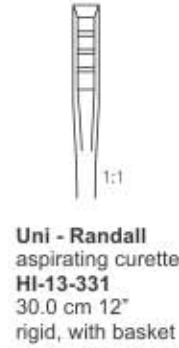

Uni - Randall
aspirating curette
HI-13-331
30.0 cm 12"
rigid, with basket

Uni - Randall
aspirating curette
HI-13-332
30.0 cm 12"
malleable,
with basket

Specimen And Aspirating Curette

- 20.0 cm 11 1/2"
- HI-13-333** 3 mm Ø
- HI-13-334** 4 mm Ø
- HI-13-335** 6 mm Ø
- HI-13-336** 8 mm Ø
- HI-13-337** 10 mm Ø
- HI-13-338** 12 mm Ø
- HI-13-339** 14 mm Ø

Coupling Piece aspirating curette
12.0 cm 4 3/4"
HI-13-340



Braun Uterine Depressor
HI-13-341 28.0 cm 11"



Blake Double Ended
HI-13-342 245mm (9.3/4")
Sharp / Blunt



Zweifel Double Ended
HI-13-343 245mm (9.3/4")
Sharp / Sharp

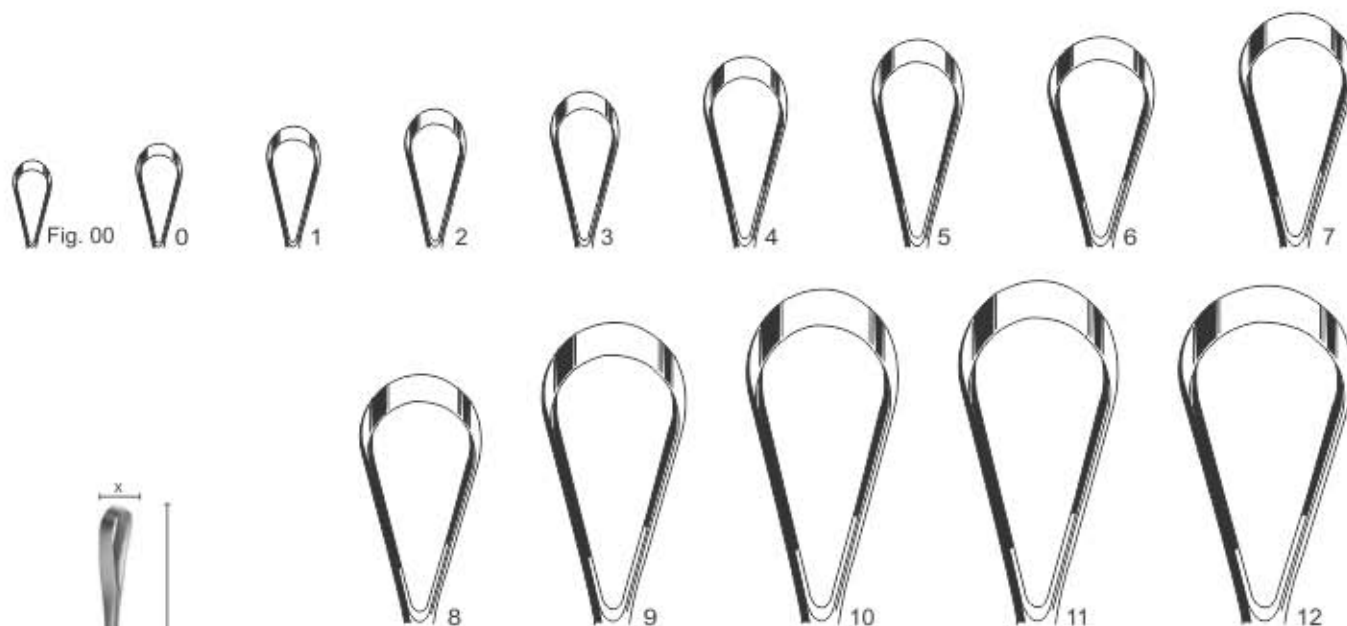

Recamier
uterine curette
y=26.0 cm 10 1/4"

Fig.	x=mm	Sharp, malleable	Blunt, malleable	Sharp, rigid	Blunt, rigid
00	5	HI-13-344	HI-13-358	HI-13-372	HI-13-386
0	6	HI-13-345	HI-13-359	HI-13-373	HI-13-387
1	7	HI-13-346	HI-13-360	HI-13-374	HI-13-388
2	8	HI-13-347	HI-13-361	HI-13-375	HI-13-389
3	9	HI-13-348	HI-13-362	HI-13-376	HI-13-390
4	11	HI-13-349	HI-13-363	HI-13-377	HI-13-391
5	12	HI-13-350	HI-13-364	HI-13-378	HI-13-392
6	14	HI-13-351	HI-13-365	HI-13-379	HI-13-393
7	15	HI-13-352	HI-13-366	HI-13-380	HI-13-394
8	16	HI-13-353	HI-13-367	HI-13-381	HI-13-395
9	19	HI-13-354	HI-13-368	HI-13-382	HI-13-396
10	20	HI-13-355	HI-13-369	HI-13-383	HI-13-397
11	21	HI-13-356	HI-13-370	HI-13-384	HI-13-398
12	23	HI-13-357	HI-13-371	HI-13-385	HI-13-399

Recamier
uterine curette
y=31.0 cm 12 1/4"

Fig.	x=mm	Sharp, malleable	Blunt, malleable	Sharp, rigid	Blunt, rigid
00	5	HI-13-400	HI-13-414	HI-13-428	HI-13-442
0	6	HI-13-401	HI-13-415	HI-13-429	HI-13-443
1	7	HI-13-402	HI-13-416	HI-13-430	HI-13-444
2	8	HI-13-403	HI-13-417	HI-13-431	HI-13-445
3	9	HI-13-404	HI-13-418	HI-13-432	HI-13-446
4	11	HI-13-405	HI-13-419	HI-13-433	HI-13-447
5	12	HI-13-406	HI-13-420	HI-13-434	HI-13-448
6	14	HI-13-407	HI-13-421	HI-13-435	HI-13-449
7	15	HI-13-408	HI-13-422	HI-13-436	HI-13-450
8	16	HI-13-409	HI-13-423	HI-13-437	HI-13-451
9	19	HI-13-410	HI-13-424	HI-13-438	HI-13-452
10	20	HI-13-411	HI-13-425	HI-13-439	HI-13-453
11	21	HI-13-412	HI-13-426	HI-13-440	HI-13-454
12	23	HI-13-413	HI-13-427	HI-13-441	HI-13-455

UTERINE CURETTES



Uterusküretten | Curettes uterinas
Curettes utérines | Curette uterine



	Fig.	x=mm	Sharp, malleable	Blunt, malleable	Sharp, rigid	Blunt, rigid
Recamier uterine curette y=34.0 cm 13 1/2"	13	25	HI-13-456	HI-13-460	HI-13-464	HI-13-468
	14	30	HI-13-457	HI-13-461	HI-13-465	HI-13-469
	15	35	HI-13-458	HI-13-462	HI-13-466	HI-13-470
	16	40	HI-13-459	HI-13-463	HI-13-467	HI-13-471

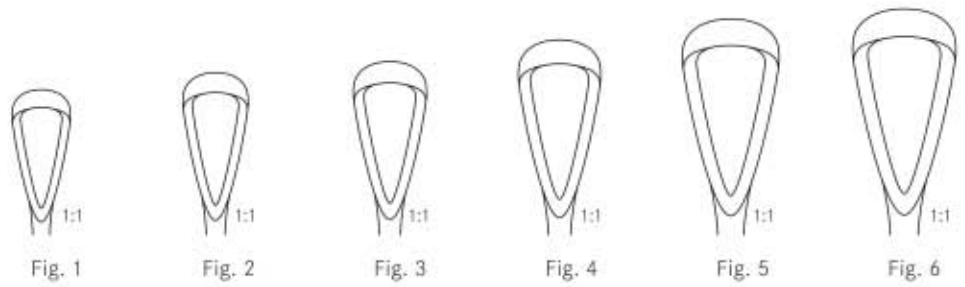

Fig.	x=mm	Sharp, malleable	Blunt, malleable	Sharp, rigid	Blunt, rigid
1	7	HI-13-472	HI-13-478	HI-13-484	HI-13-490
2	8	HI-13-473	HI-13-479	HI-13-485	HI-13-491
3	9	HI-13-474	HI-13-480	HI-13-486	HI-13-492
4	11	HI-13-475	HI-13-481	HI-13-487	HI-13-493
5	12	HI-13-476	HI-13-482	HI-13-488	HI-13-494
6	14	HI-13-477	HI-13-483	HI-13-489	HI-13-495

Sims
uterine curette
27.9 cm 11"

UTERINE SPOONS

Scharfe Löffel
Curettes tranchantes

Cucharillas cortantes
Cucchiai tahlienti



Schröder
Uterine Spoon



Fig. 1
HI-13-496
25.0 cm 9 3/4"
Sharp, rigid



Fig. 2
HI-13-497
25.0 cm 9 3/4"
Sharp, rigid



Fig. 3
HI-13-498
25.0 cm 9 3/4"
Sharp, rigid



Fig. 4
HI-13-499
25.0 cm 9 3/4"
Sharp, rigid



Fig. 5
HI-13-500
25.0 cm 9 3/4"
Sharp, rigid



Fig. 6
HI-13-501
25.0 cm 9 3/4"
Sharp, rigid



Schröder
Uterine Spoon



Fig. 1
HI-13-502
30.0 cm 12"



Fig. 2
HI-13-503
30.0 cm 12"



Fig. 3
HI-13-504
30.0 cm 12"



Fig. 4
HI-13-505
30.0 cm 12"



Fig. 5
HI-13-506
30.0 cm 12"



Fig. 6
HI-13-507
30.0 cm 12"

PELVIMETER, OBSTETRICAL FORCEPS



Beckenzirkel, Geburtszangen | Pelvimetro, Forceps obstétricos
 Pelvimètre, Forceps obstétriques | Pelvimetri, Forcipi obstetrici



Thole Pelvimeter,
Obstetrical Forceps
HI-13-508
 for internal and external measurements,
 graduated in centimeters



De Lee Pelvimeter,
Obstetrical Forceps
HI-13-509
 graduated in centimeters
 and inches



Collin Pelvimeter,
Obstetrical Forceps
HI-13-510
 Graduated in
 Centimeters



Martin Pelvimeter,
Obstetrical Forceps
HI-13-511
 graduated in
 centimeters



Collin Pelvimeter,
Obstetrical Forceps
HI-13-512
 graduated in centimeters

The additional straight arm
 can be replaced. The pelvimeter
 with straight arm is used for
 localisation of the portio vaginalis
 uteri and of vaginal metastasis.



Breisky Pelvimeter,
Obstetrical Forceps
HI-13-513
 graduated in
 centimeters



Simpson
obstetrical forceps
HI-13-514
30.0 cm 12"



Simpson - Braun
obstetrical forceps
HI-13-515 33.0 cm 13"
HI-13-516 36.0 cm 14 1/4"



Naegele
obstetrical forceps
HI-13-517 36.0 cm 14 1/4"
HI-13-518 40.0 cm 16"



Piper
obstetrical forceps
HI-13-519
44.0 cm 17 1/4"



Simpson - Luikart
obstetrical forceps
HI-13-520
36.0 cm 14 1/4"



Wrigley
obstetrical forceps
HI-13-521 25.0 cm 9 3/4"
for caesarian section



De Lee
obstetrical forceps
HI-13-522
30.0 cm 12"



De Lee
obstetrical forceps
HI-13-523 36.0 cm 14 1/4"
HI-13-524 15.0 cm 15 1/2"

OBSTETRICAL FORCEPS



Geburtszangen

Forceps obstétricos

Forceps obstétriquis

Forcipi



Elliot
obstetrical forceps
HI-13-525 32.0 cm 12 1/2"
HI-13-526 38.0 cm 15"



McLean
obstetrical forceps
HI-13-527 36.0 cm 14 1/4"



Kielland
obstetrical forceps
HI-13-528 41.0 cm 16 1/4"



Kielland-Luikart
obstetrical forceps
HI-13-529 40.0 cm 16"



Braun
obstetrical forceps
HI-13-530
42.0 cm 16 1/2"
Cranioclast, one
jaw fenestrated



Tarnier
obstetrical forceps
HI-13-531
46.0 cm 17 1/4"
Basiotribe



Sellheim
Obstetrical Lever
HI-13-532
28.0 cm 11"

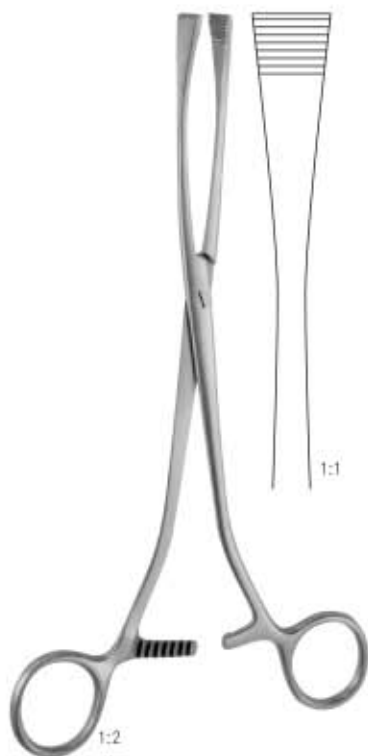

Green-Armytage
 Uterine Elevating Forceps
 HI-13-533 21.0 cm 8 1/4"



Smellie
 Obstetrical Forceps
 HI-13-534 25.0 cm 10"
 Perforator

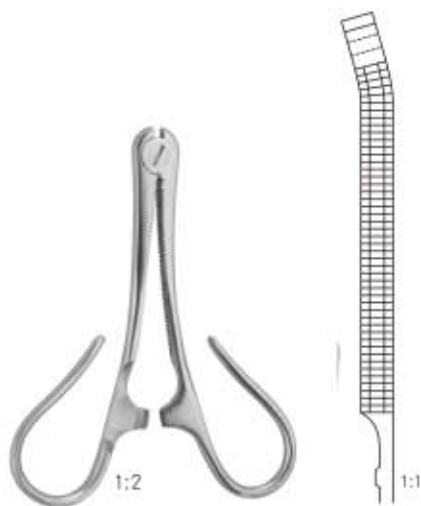

Kane
 obstetrical forceps
 HI-13-535
 85.0 cm 3 1/4"



Collin
 obstetrical forceps
 HI-13-536
 90.0 cm 3 1/2"



Braun, Midwifery
 Decapitating hook
 HI-13-537
 32.5 cm 12 3/4"

ABORTION FORCEPS - OVUM CURETTES



Abortuszangen - Abortusküretten

Pinzas para abort - Curetas para aborto

Pinces à faux germes - Curette d'avortement

Pinze per placenta ed aborto - Curette per placenta ed aborto

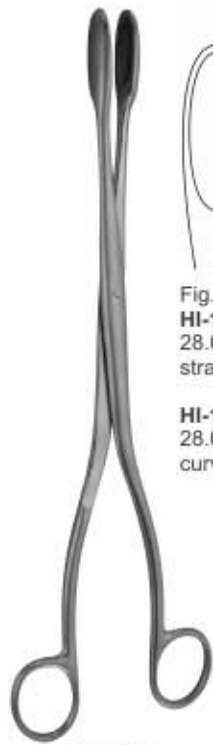

Winter
abortion forceps



Fig. 1
HI-13-538
28.0 cm 11"
straight

HI-13-539
28.0 cm 11"
curved



Fig. 2
HI-13-540
28.0 cm 11"
straight

HI-13-541
28.0 cm 11"
curved

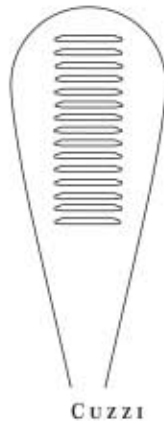

Fig. 3
HI-13-542
28.0 cm 11"
straight

HI-13-543
28.0 cm 11"
curved



Cuzzi
ovum curette
blunt, back serrated



Cuzzi



14.5 mm
HI-13-544
30.0 cm 12"



18.0 mm
HI-13-545
30.0 cm 12"



21.0 mm
HI-13-546
30.0 cm 12"



Saenger
abortion forceps



HI-13-547
27.0 cm 10 3/4"
Straight



HI-13-548
27.0 cm 10 3/4"
Curved



Wallich
ovum curette
HI-13-549 42.0 cm 16 1/2"



Pestalozza
ovum curette
HI-13-550 30.0 cm 12"

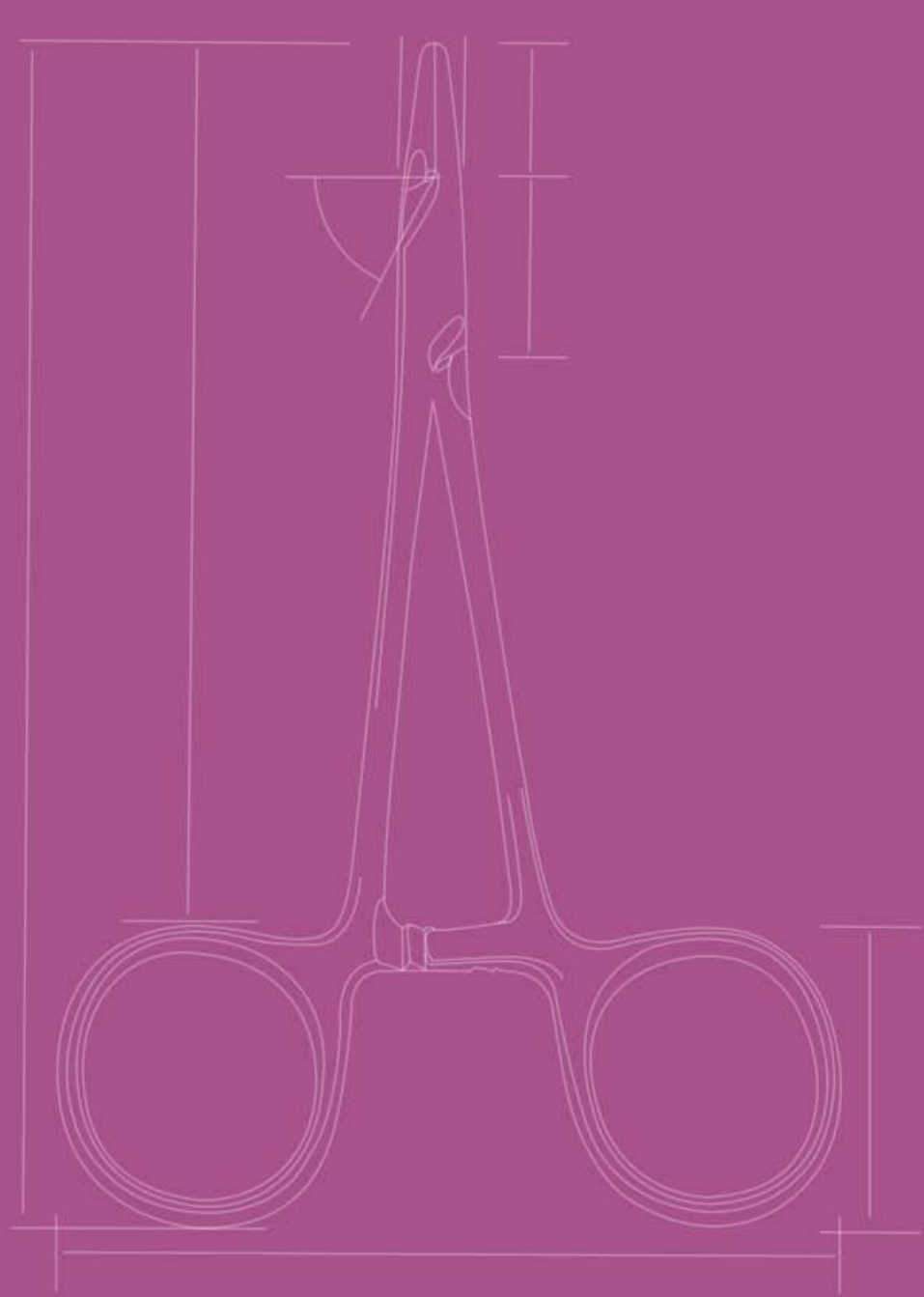

HOMEDICA
INTERNATIONAL