

Surgical Instruments Catalogue

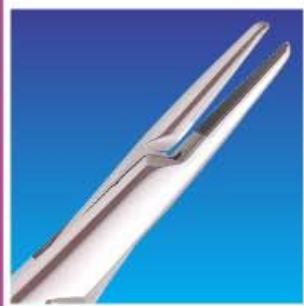

HOMEDICA
INTERNATIONAL



HOMEDICA INTERNATIONAL

Homedica feels great honor introducing itself to be one of the leading manufacturing company of surgical & dental instruments. Professional always prefer Homedica instruments, which is our pride.

Our all instruments are manufactured by the high quality stainless steel made on our requirements, every instrument is hand crafted with the highest workmanship available in the industry. Through heat treatment, the instruments are hardened and tempered for proper functioning and long life. All instruments are polished electrolytically and manually for maximum resistance to corrosion and long life. Homedica pays special attention to the needs of doctors, with innovative designs to meet the needs of professionals. The wide assortment of standard patterns and exclusive Homedica designs gives you the most desirable range of surgical and dental instruments.

Over the several years, we have earned the reputation of for maintaining highest quality standards of quality and service. To manufacture instruments that meet with your changing demands is our achievement. Our highly skilled staff of professionals will continue to serve your needs and will try their outmost to uplift the standards which we have set in the past.

With your co-operation and guidance, Homedica will continue serving surgical and dental instruments in future.

Management of Homedica international

BASIC METHODS FOR HANDLING AND CARE OF SURGICAL AND DENTAL INSTRUMENTS

Dear Customers:

We have received some questions concerning staining, pitting or rusting in stainless steel instruments. So, we took great honour and pleasure in guiding our respected customers to eliminate the problems about staining or rusting etc. The points are as follows:-

- 1) Rinse the instruments as soon as possible after use to remove blood and serum.
- 2) Dry the instruments after cleaning or before wrapping and storing, if not so, moisture left can cause rust and corrosion.
- 3) Do not leave instruments in cold sterilization solution for a long period, as the solution may lead the instrument to be corrosive.
- 4) Never use caustic cleaners, use those specified for cleaning surgical instruments.
- 5) Avoid cleaning instruments with steel wool; if want to clean with hand, use detergent soap and a soft brush and finally treat with distilled water.
- 6) You should check your autoclave; Iron, calcium, sodium or copper in water can cause rusting, staining or corrosion.
- 7) Leaving of instruments for a long time in the following solutions can also cause corrosion.
 - i) Phenol or Iodine.
 - ii) Aluminium, Barium or Calcium.
 - iii) Any Acid, Mercury or Potassium solution.
- 8) Try your utmost not to sterilize stainless steel instrument with chrome plated brass instruments, as any break in chrome surface may cause pitting or rusty surface in instruments.
- 9) Muslin wraps should be rinsed sufficiently by the laundry, so that all chlorine bleach may remove, which can cause corrosion or custing during autoclaving.

We hope that by acting on the above instructions, your problems relating to rusting, staining or pitting would abolish and the age of your instrument would increase.

MANAGEMENT

DRESSING & TISSUE FORCEPS



Anatomische pinzetten, chirurgische pinzetten
 Pinzas de disección, pinzas de disección condientes

Pinces à dissection, pincés à griffes
 Pinze Anatomiche per dissezion, pinze chirurgiche a dentiditopo



HI-05-001
 10.5 cm, 4 1/4"
 serrated



HI-05-002
 11.5 cm, 4 1/2"
 serrated



HI-05-003
 13 cm, 5"
 serrated

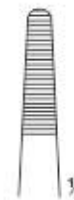

HI-05-004
 14.5 cm, 5 3/4"
 serrated



HI-05-005
 16 cm 6 1/4"
 serrated

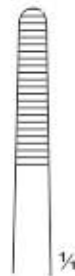

HI-05-006
 18 cm, 7"
 serrated

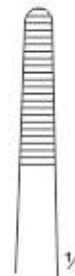

HI-05-007
 20 cm, 8"
 serrated

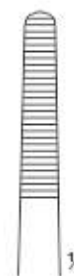

HI-05-008
 25 cm, 10"
 serrated



HI-05-009
 30 cm, 12"
 serrated

STANDARD DRESSING FORCEPS



HI-05-010
 10.5 cm, 4 1/4"



HI-05-011
 11.5 cm, 4 1/2"



HI-05-012
 13 cm, 5"



HI-05-013
 14.5 cm, 5 3/4"

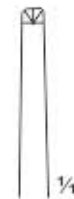

HI-05-014
 16 cm 6 1/4"



HI-05-015
 18 cm, 7"



HI-05-016
 20 cm, 8"



HI-05-017
 25 cm, 10"



HI-05-018
 30 cm, 12"

STANDARD TISSUE FORCEPS 1x2 teeth

TISSUE & DRESSING FORCEPS



Pinzas para tejidos, Pincas à dissection | Pincas a tissu, Anatomische pinzetten
 Pinze per tessuti, Pinze per dissezione | Gewebe, Pinzas de disección



Mod. USA, Tissue Forceps
 1x2 teeth
 HI-05-019 10.2 cm, 4"
 HI-05-020 11.4 cm, 4.5"
 HI-05-021 12.7 cm, 5"
 HI-05-022 14.0 cm, 5.5"
 HI-05-023 15.2 cm, 6"
 HI-05-024 17.8 cm, 7"
 HI-05-025 20.3 cm, 8"
 HI-05-026 25.4 cm, 10"
 HI-05-027 30.5 cm, 12"



Mod. USA, Dressing Forceps serrated
 HI-05-028 12 cm, 4 3/4"
 HI-05-029 13 cm, 5"
 HI-05-030 14.5 cm, 5 3/4"
 HI-05-031 15.5 cm, 6"
 HI-05-032 18 cm, 7"
 HI-05-033 21 cm, 8 1/4"
 HI-05-034 25 cm, 10"
 HI-05-035 31 cm, 12 1/4"



MOD. MARTIN Dressing Forceps
 HI-05-036 12.7 cm, 5"
 HI-05-037 14.0 cm, 5.5"



Standard Dressing Forceps
 HI-05-038 11.4 cm, 4.5"
 HI-05-039 12.7 cm, 5"
 HI-05-040 14.0 cm, 5.5"
 HI-05-041 15.2 cm, 6"
 HI-05-042 17.8 cm, 7"
 HI-05-043 20.3 cm, 8"
 HI-05-044 25.4 cm, 10"
 HI-05-045 30.5 cm, 12"
 Curved, serrated

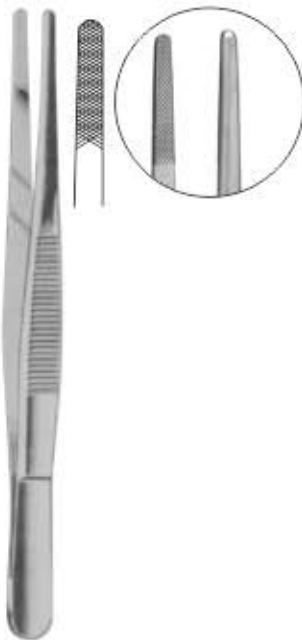

Standard Dressing Forceps wide pattern cross serration
 HI-05-046 11.4 cm, 4.5"
 HI-05-047 12.7 cm, 5"
 HI-05-048 14.0 cm, 5.5"
 HI-05-049 15.2 cm, 6"
 HI-05-050 17.8 cm, 7"
 HI-05-051 20.3 cm, 8"
 HI-05-052 25.4 cm, 10"
 HI-05-053 30.5 cm, 12"



Standard Dressing Forceps Narrow Point
 HI-05-054 12.7 cm, 5" serrated
 HI-05-055 14 cm, 5.5" serrated
 HI-05-056 15.2 cm, 6" serrated
 HI-05-057 17.8 cm, 7" serrated
 HI-05-058 20.3 cm, 8" serrated
 HI-05-059 25.4 cm, 10" serrated
 HI-05-060 30.5 cm, 12" serrated



SEMKEN Dressing Forceps straight serrated
 HI-05-061 12.5 cm, 5"
 HI-05-062 15.5 cm, 6"

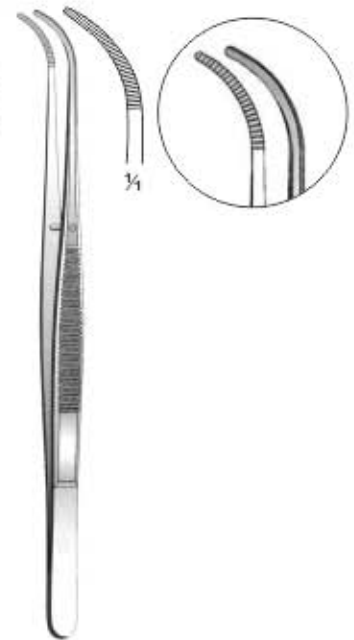

SEMKEN Dressing Forceps curved serrated
 HI-05-063 12.5 cm, 5"
 HI-05-064 15.5 cm, 6"

Pinces a tissu, Anatomische pinzetten | Pinzas para tejidos, Pincas à dissection
Gewebe, Pinzas de disección | Pinze per tessuti, Pinze per dissezione



POTTS-SMITH Dressing Forceps
HI-05-065 17.5 cm, 7"
HI-05-066 21.0 cm, 8 1/4"
HI-05-067 25.0 cm, 10"
 straight serrated



POTTS-SMITH Dressing Forceps
HI-05-068 17.5 cm, 7"
HI-05-069 21.0 cm, 8 1/4"
HI-05-070 25.0 cm, 10"
 curved serrated



POTTS-SMITH Tissue Forceps 1x2 teeth
HI-05-071 17.5 cm, 7"
HI-05-072 21.0 cm, 8 1/4"
HI-05-073 25.0 cm, 10"
 straight



POTTS-SMITH Tissue Forceps 1x2 teeth
HI-05-074 17.5 cm, 7"
HI-05-075 21.0 cm, 8 1/4"
HI-05-076 25.0 cm, 10"
 curved



Brophy Dressing Forceps
HI-05-077 20.0 cm, 8"
 straight serrated



Brophy Dressing Forceps
HI-05-078 20.0 cm, 8"
 curved serrated



Brophy Tissue Forceps 1x2 teeth
HI-05-079 20.0 cm, 8"
 straight serrated

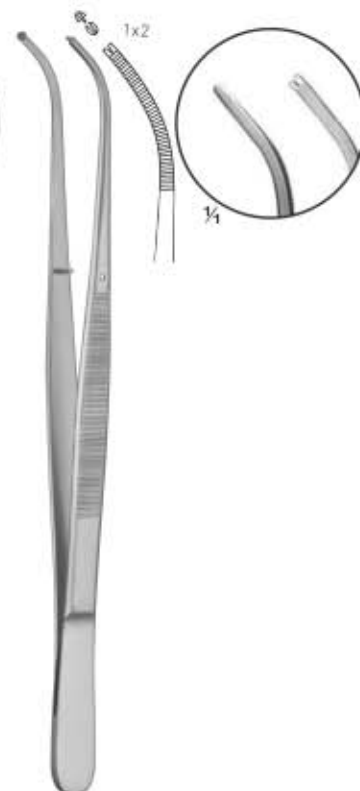

Brophy Tissue Forceps 1x2 teeth
HI-05-080 20.0 cm, 8"
 curved serrated

TISSUE & DRESSING FORCEPS



Pinzas para tejidos, Pincas à dissection | Pincas a tissu, Anatomische pinzetten
 Pinze per tessuti, Pinze per dissezione | Gewebe, Pinzas de disección



WANGENSTEEN
 Dressing Forceps
 HI-05-081 23 cm, 9"



Bulldog Straight
 HI-05-081 A 4cm
 HI-05-081 B 5cm
 HI-05-081 C 6cm

Bulldog Curved
 HI-05-081 D 4cm
 HI-05-081 E 5cm
 HI-05-081 F 6cm



Bishop Forceps
 HI-05-081 G 8cm



Stone Tissue Forceps
 4X5 Teeth
 HI-05-082 15.2 cm, 6"



Lerche Tissue Forceps
 5X6 Teeth
 HI-05-083 15 cm, 6"



Adlerkreutz Tissue Forceps 2X3 Teeth
 HI-05-084 15 cm, 6"
 HI-05-085 20 cm, 8"



Adlerkreutz Tissue Forceps 4X5 Teeth
 HI-05-086 15 cm, 6"
 HI-05-087 20 cm, 8"

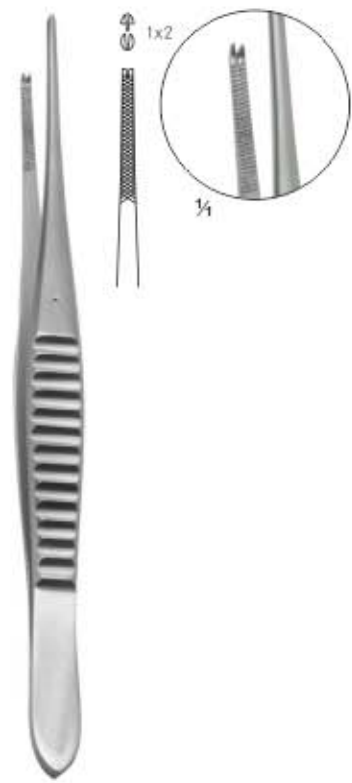

Gillies Tissue Forceps 1X2 Teeth
 HI-05-088 15 cm, 6"
 straight serrated



Gillies Tissue Forceps 1X2 Teeth
 HI-05-089 15 cm, 6"
 curved serrated

Pinzas para tejidos, Pincas à dissection
Pinze per tessuti, Pinze per dissezione

Pincas a tissu, Anatomische pinzetten
Gewebe, Pinzas de disección



Tissue Forceps 2x3 Teeth
 HI-05-090 11.4 cm 4 1/2"
 HI-05-091 13.0 cm 5"
 HI-05-092 14.5 cm 5 3/4"
 HI-05-093 16.0 cm 6 1/4"
 HI-05-094 17.5 cm 7"
 HI-05-095 20.0 cm 8"
 HI-05-096 25.0 cm 10"
 HI-05-097 30.0 cm 12"



Tissue Forceps 3x4 Teeth
 HI-05-098 11.4 cm 4 1/2"
 HI-05-099 12.7 cm 5"
 HI-05-100 14 cm 5 1/2"
 HI-05-101 15.9 cm 6 1/4"
 HI-05-102 17.8 cm 7"
 HI-05-103 20.3 cm 8"
 HI-05-104 25.4 cm 10"
 HI-05-105 30.5 cm 12"



Tissue Forceps 4x5 Teeth
 HI-05-106 11.4 cm 4 1/2"
 HI-05-107 12.7 cm 5"
 HI-05-108 14 cm 5 1/2"
 HI-05-109 15.9 cm 6 1/4"
 HI-05-110 17.8 cm 7"
 HI-05-111 20.3 cm 8"
 HI-05-112 25.4 cm 10"
 HI-05-113 30.5 cm 12"

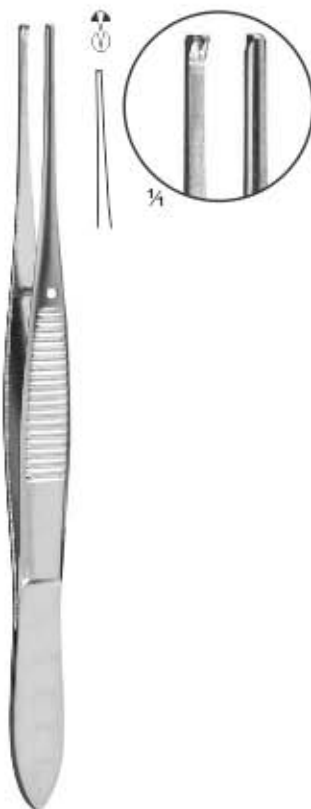

Iris Tissue Forceps
 HI-05-114 10.2 cm, 4"
 1x2 Teeth, Straight



Iris Tissue Forceps
 HI-05-115 10.2 cm, 4"
 1x2 Teeth, Half Curved



Iris Tissue Forceps
 HI-05-116 10.2 cm, 4"
 1x2 Teeth, Full Curved

TISSUE & DRESSING FORCEPS



Pinzas para tejidos, Pincers à dissection | *Pincers a tissu, Anatomische pinzetten*
Pinze per tessuti, Pinze per dissezione | *Gewebe, Pinzas de disección*



Waugh Dressing Forceps
HI-05-117 15.0 cm, 6"
HI-05-118 18.0 cm, 7"
 slightly heavier
 non-toothed,
 serrated jaws.



Waugh Tissue Forceps
1x2 Teeth
HI-05-119 15.0 cm, 6"
HI-05-120 18.0 cm, 7"
 as above but one two
 tooth on serrated jaws.
 Known as Scott.



Leedham Tissue Forceps
1x2 Teeth
HI-05-121 14.5 cm, 5.75"
HI-05-122 18.0 cm, 7"
 Green Dissecting
 Forceps two three
 teeth, smooth jaws.



Treves Tissue Forceps
1x2 Teeth
HI-05-123 12.5 cm, 5"
HI-05-124 15.0 cm, 6"
HI-05-125 18.0 cm, 7"
 Dissecting Forceps
 teeth, on smooth jaws.



Charnley Tissue Forceps
1x2 Teeth
HI-05-126 14.5 cm, 5 3/4"
HI-05-127 18.0 cm, 7"
 Dissecting Forceps
 one into two teeth,
 block on jaws.



Ramsay Dissecting Forceps
HI-05-128 18.0 cm, 7"
 serrated jaws.



Ramsay Tissue Forceps
1x2 Teeth
HI-05-129 18.0 cm, 7"
 Dissecting Forceps
 one into teeth on
 serrated jaws.



Dissecting Dressing
Forceps
HI-05-130 12.5 cm, 5"
HI-05-131 15.0 cm, 6"
HI-05-132 18.0 cm, 7"
 turn over end,
 serrated jaws.



Dissecting Dressing
Forceps
HI-05-133 12.5 cm, 5"
HI-05-134 15.0 cm, 6"
HI-05-135 18.0 cm, 7"
HI-05-136 20.0 cm, 8"
 block end, serrated
 jaws.

Pinces a tissu, Anatomische pinzetten
Gewebe, Pinzas de disección

Pinzas para tejidos, Pinces à dissection
Pinze per tessuti, Pinze per dissezione



Ferris-Smith Tissue Forceps 1x2 Teeth
HI-05-137
18 cm, 7"

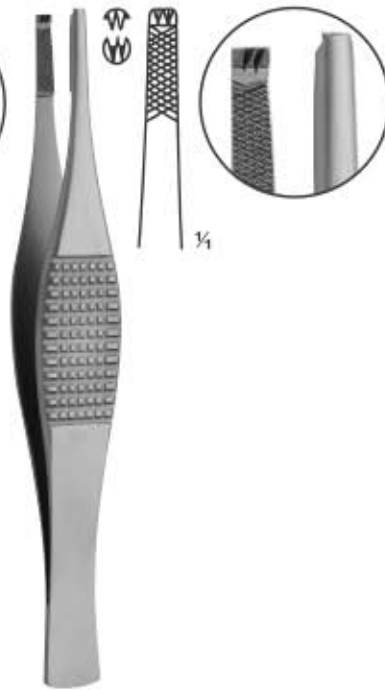

Ferris-Smith Tissue Forceps 2x3 Teeth
HI-05-138
18 cm, 7"

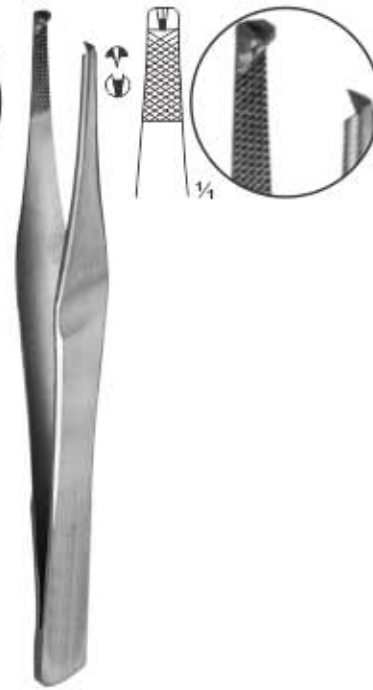

Lane Tissue Forceps 1x2 Teeth
HI-05-139 12.5cm, 5 1/2"
HI-05-140 15 cm, 6"
HI-05-141 17 cm, 6 3/4"
HI-05-142 18 cm, 7"
HI-05-143 20 cm, 8"

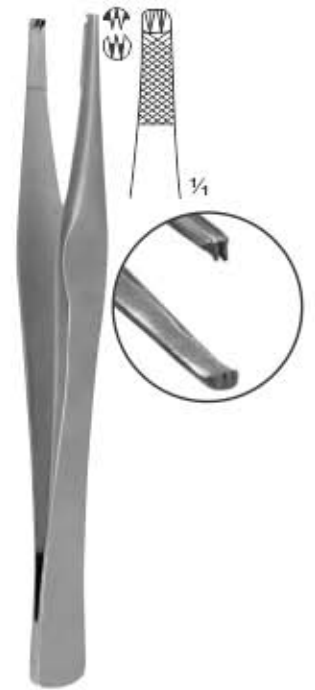

Lane Tissue Forceps 2x3 Teeth
HI-05-144 12.5cm, 5 1/2"
HI-05-145 15 cm, 6"
HI-05-146 17 cm, 6 3/4"
HI-05-147 18 cm, 7"
HI-05-148 20 cm, 8"

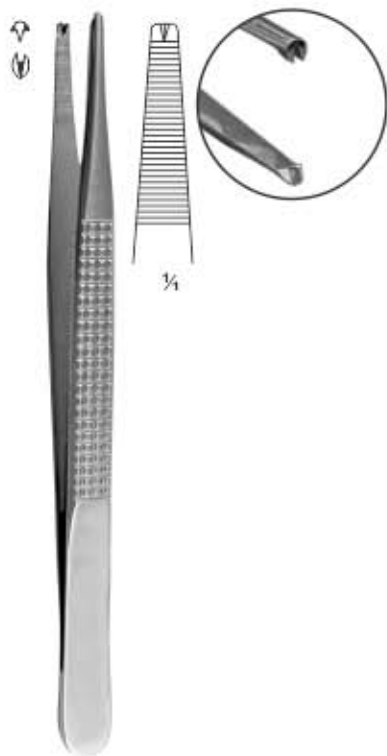

Bonney Tissue Forceps 1x2 Teeth
HI-05-149
18 cm, 7"

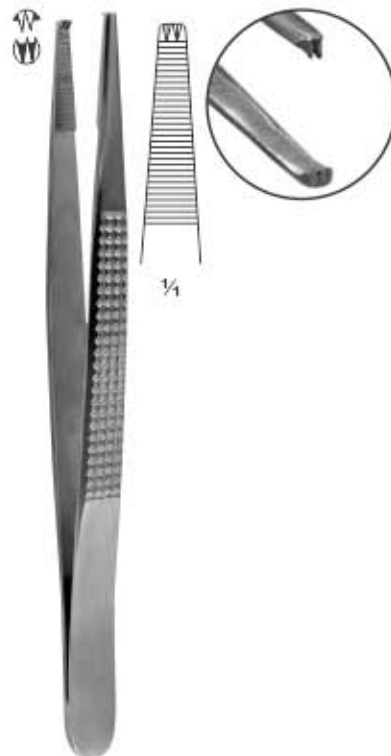

Bonney Tissue Forceps 2x3 Teeth
HI-05-150
18 cm, 7"



Durante Tissue Grasping Forceps
HI-05-151 14.5cm, 5 3/4"
HI-05-152 16 cm, 6 1/4"
HI-05-153 20 cm, 8"



Nelson Tissue Forceps
HI-05-154 23 cm, 9"
6x7 Teeth

TISSUE & DRESSING FORCEPS



Pinzas para tejidos, Pincas à dissection | *Pincas a tissu, Anatomische pinzetten*
Pinze per tessuti, Pinze per dissezione | *Gewebe, Pinzas de disección*

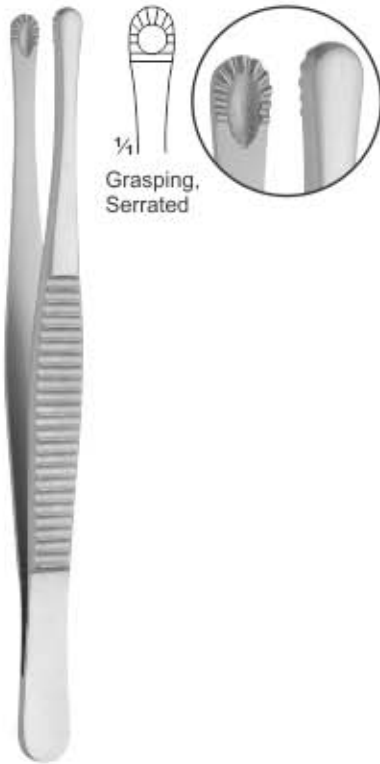

1/4
Grasping,
Serrated

**Russian-Modell
Tissue Forceps**
 HI-05-155 15 cm, 6"
 HI-05-156 20 cm, 8"
 HI-05-157 25 cm, 10"



1/4

**Singley-Tuttle
Forceps**
 HI-05-158
 23 cm, 9"



**Collin-Duval
Forceps**

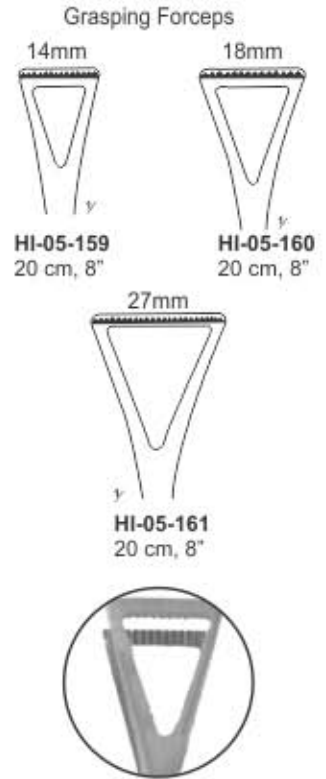

Grasping Forceps

14mm

18mm

HI-05-159
20 cm, 8"

HI-05-160
20 cm, 8"

27mm

HI-05-161
20 cm, 8"

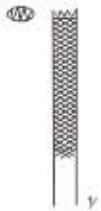

**Stille-Barraya Tissue
Forceps 3x4 Teeth**
 HI-05-162 18 cm, 7"
 HI-05-163 20 cm, 8"
 HI-05-164 25 cm, 10"



**Duehrssen Dressing
Forceps**
 HI-05-165 20 cm, 8"
 Serrated



**Duehrssen Tissue
Forceps 1x2 Teeth**
 HI-05-166
 20 cm, 8"



**Duehrssen Tissue
Forceps 2x3 Teeth**
 HI-05-167
 20 cm, 8"

Pinzas para tejidos, Pincas à dissection
Pinze per tessuti, Pinze per dissezione

Pincas a tissu, Anatomische pinzetten
Gewebe, Pinzas de disección

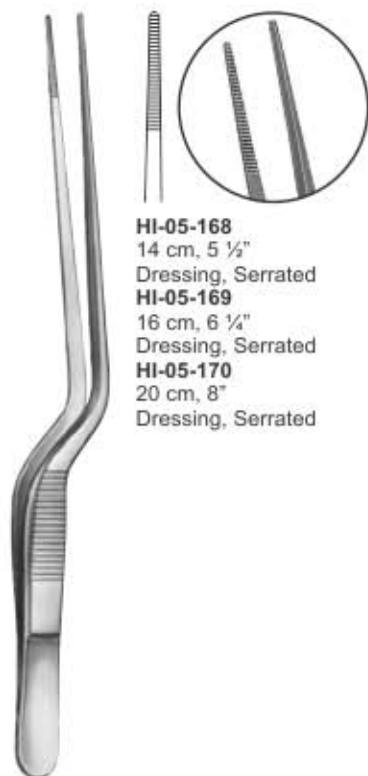

HI-05-168
14 cm, 5 1/2"
Dressing, Serrated
HI-05-169
16 cm, 6 1/4"
Dressing, Serrated
HI-05-170
20 cm, 8"
Dressing, Serrated

LUCAE / ENT Dressing Forceps



Paper Dressing Forceps
HI-05-171 15 cm, 6"



Paper Dressing Forceps
HI-05-172 15 cm, 6"



Paper Dressing Forceps
HI-05-173 15 cm, 6"
Curved

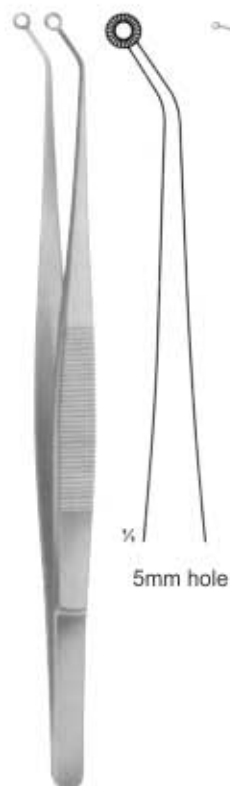

Hunt Tumor and Vessel Forceps
HI-05-174
20 cm, 8"



Sanii Forceps
Spoon-Shaped Jaws Left
HI-05-175
24 cm, 9 1/2"
3mm hole



HI-05-176
24 cm, 9 1/2"
4mm hole



HI-05-177
24 cm, 9 1/2"
5mm hole



Sanii Forceps
Spoon-Shaped Jaws Right
HI-05-178
24 cm, 9 1/2"
3mm hole



HI-05-179
24 cm, 9 1/2"
4mm hole



HI-05-180
24 cm, 9 1/2"
5mm hole

TISSUE & DRESSING FORCEPS



Pinces a tissu, Anatomische pinzetten
Gewebe, Pinzas de disección

Pinzas para tejidos, Pinces à dissection
Pinze per tessuti, Pinze per dissezione



HI-05-181 regular point straight
HI-05-182 fine point straight
HI-05-183 mirco point straight
12 cm, 4 3/4" 1x2 Teeth



HI-05-187 regular point curved
HI-05-188 fine point curved
HI-05-189 mirco point curved
12 cm, 4 3/4" 1x2 Teeth



HI-05-184 regular point with platform straight
HI-05-185 fine point with platform straight
HI-05-186 mirco point with platform straight
12 cm, 4 3/4" 1x2 Teeth



HI-05-190 regular point straight
HI-05-191 fine point straight
HI-05-192 mirco point straight
12 cm, 4 3/4" 1x2 Teeth



HI-05-193 regular point, straight
HI-05-194 fine point, straight
Forceps, 12cm 4 3/4"
9x9 teeth



HI-05-195 regular point, Curved
HI-05-196 fine point, Curved
Forceps, 12cm 4 3/4"
9x9 teeth

Adson Tissue Forceps
Cuter Print

Adson Brown Tissue



HI-05-197 regular point straight
HI-05-198 fine point straight
HI-05-199 mirco point straight
12 cm, 4 3/4" 1x2 Teeth



HI-05-203 regular point curved
HI-05-204 fine point curved
HI-05-205 mirco point curved
12 cm, 4 3/4" 1x2 Teeth



HI-05-200 regular point with platform straight
HI-05-201 fine point with platform straight
HI-05-202 mirco point with platform straight
12 cm, 4 3/4" 1x2 Teeth



HI-05-206 regular point curved
HI-05-207 fine point curved
HI-05-208 mirco point curved
12 cm, 4 3/4" 1x2 Teeth



HI-05-209 regular point, straight
HI-05-210 fine point, straight
12cm 4 3/4"
7x7 teeth



HI-05-211 regular point, Curved
HI-05-212 fine point, Curved
12cm 4 3/4"
7x7 teeth

Adson Tissue Forceps
with fenestrated handle

Adson Brown Tissue Forceps
Fenestrated Handle

Pinces a tissu, Anatomische pinzetten
Gewebe, Pinzas de disección

Pinzas para tejidos, Pinces à dissection
Pinze per tessuti, Pinze per dissezione

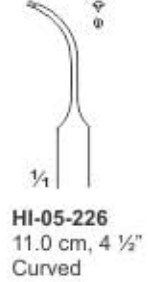
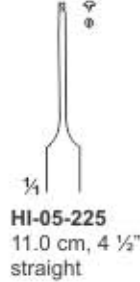
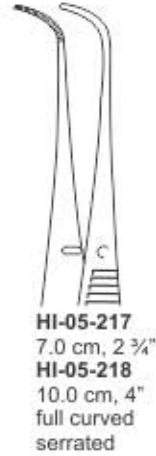
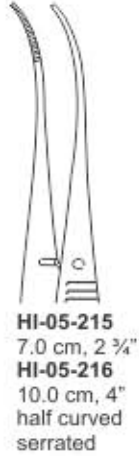
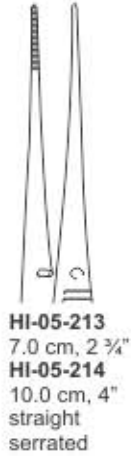

Graefe Forceps

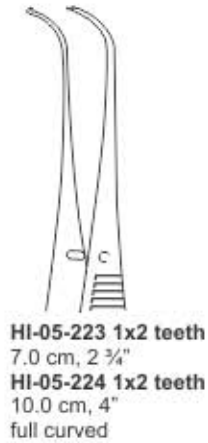
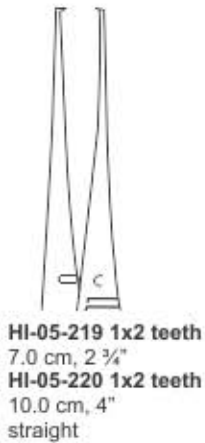

Stevens Tissue Forceps 1x2 Teeth

Stevens Tissue Forceps 1x2 Teeth



Graefe Dressing Forceps
HI-05-227 0.5 mm
HI-05-228 0.7 mm
HI-05-229 1.0 mm
7.0 cm, 3"
straight serrated

Graefe Dressing Forceps
HI-05-230 0.5 mm
HI-05-231 0.7 mm
HI-05-232 1.0 mm
7.0 cm, 3"
curved serrated

Graefe Tissue Forceps 1x2 Teeth
HI-05-233 0.5 mm
HI-05-234 0.7 mm
HI-05-235 1.0 mm
7.0 cm, 3"
straight

Graefe Tissue Forceps 1x2 Teeth
HI-05-236 0.5 mm
HI-05-237 0.7 mm
HI-05-238 1.0 mm
7.0 cm, 3"
curved

Graefe Fixation Forceps
HI-05-239
11.2 cm 4 3/8"
standard jaws 4.5mm wide
with fine teeth

JEWELER TYPE, DISSECTING FORCEPS



Chirurgische pinzetten, Uhrmacher-Pinzetten

Pinces à dissection à groffes, Pinces d'horloger

Pinzas de disección con dientes, Pinzas de relojero

Pinze per dissezione con denti, Pinze de orologiaio



Dumont Forceps
HI-05-240 11.5 cm, 4 1/2"
curved



1/4
HI-05-241
10.5 cm, 4"
full curved



1/4
HI-05-242
10.5 cm, 4"
half curved



HI-05-243
11 cm, 4 1/2"



HI-05-244
11 cm, 4 1/2"
fine point



1/4
HI-05-245
11 cm, 4 1/2"
extra fine point



HI-05-246
12 cm, 5"
fine point



HI-05-247
12 cm, 5"
extra fine point



HI-05-248
12 cm, 5"



Dumont Forceps
HI-05-249
style 1, fine point,
12.1 cm 4 3/4"



Dumont Forceps
HI-05-250
style 2, strong
fine point,
12.1 cm 4 3/4"



Dumont Forceps
HI-05-251
style 3, narrow
fine point,
12.1 cm 4 3/4"



Dumont Forceps
HI-05-252
style 3C, narrow
fine point,
11.2 cm 4 3/8"

Chirurgische pinzetten, Uhrmacher-Pinzetten
Pinzas de disección con dientes, Pinzas de relojero

Pinces à dissection à groffes, Pinces d'horloger
Pinze per dissezione con denti, Pinze de orologiaio



Dumont Forceps
HI-05-253
 style 4, fine point,
 11.2cm 4 3/8"



Dumont Forceps
HI-05-254
 style 5, super fine
 11.2cm point, 4 3/8"



Dumont Forceps
HI-05-255
 style 5, micro fine
 11.2cm point, 4 3/8"



Dumont Forceps
HI-05-256
 style 6, pick up,
 11.4 cm 4 1/2"



Dumont Forceps
HI-05-257
 style 7, fine curved,
 11.4 cm 4 1/2"



Dumont Forceps
HI-05-258
 style 7, micro fine
 11.4 cm curved, 4 1/2"

CILIA FORCEPS



Cilienpinzetten
Pinzas depilatorias

Pincès à épiler les cils
Pinze depilatoria



Ziegler Cilia Forceps
HI-05-259
9 cm, 3 1/2"



Douglas Cilia Forceps
HI-05-260
9 cm, 3 1/2"



Beer Cilia Forceps
HI-05-261
9 cm, 3 1/2"



Gradle Cilia Forceps
HI-05-262
10.5cm, 4"



Kuehne Cilia Forceps
HI-05-263
10.5cm, 4"



Kuehne Cilia Forceps
HI-05-264
10.5cm, 4"
angled sideways



Barraquer Cilia Forceps
HI-05-265
10.5cm, 4"



Littauer Cilia Forceps
HI-05-266
8.5 cm, 3"



Littauer Cilia Forceps
HI-05-267
9 cm, 3 1/2"

SPLINTER FORCEPS

Splitterpinzetten | Pincas à échardes
Pinzas Para espinas | Pinze per scheggie



Splinter Forceps

HI-05-268 8 cm, 3"
HI-05-269 9 cm, 3 1/2"
HI-05-270 10.5 cm, 4"
HI-05-271 11.5 cm, 4 1/2"
HI-05-272 12.5 cm, 5"
HI-05-273 14.5 cm, 5 1/2"
Straight Plain



Splinter Forceps

HI-05-274 8 cm, 3"
HI-05-275 9 cm, 3 1/2"
HI-05-276 10.5 cm, 4"
HI-05-277 11.5 cm, 4 1/2"
HI-05-278 12.5 cm, 5"
HI-05-279 14.5 cm, 5 1/2"
Curved Plain



Splinter Forceps

HI-05-280 8 cm, 3"
HI-05-281 9 cm, 3 1/2"
HI-05-282 10.5 cm, 4"
HI-05-283 11.5 cm, 4 1/2"
HI-05-284 12.5 cm, 5"
HI-05-285 14.5 cm, 5 1/2"
Straight serrated

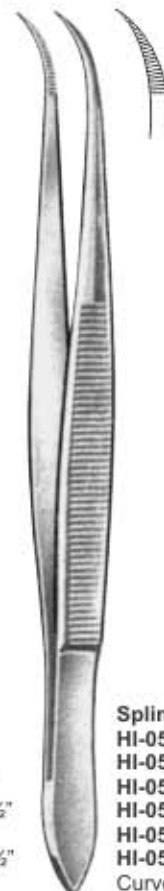

Splinter Forceps

HI-05-286 8 cm, 3"
HI-05-287 9 cm, 3 1/2"
HI-05-288 10.5 cm, 4"
HI-05-289 11.5 cm, 4 1/2"
HI-05-290 12.5 cm, 5"
HI-05-291 14.5 cm, 5 1/2"
Curved serrated



HI-05-292
7.5 cm, 3"
HI-05-293
9 cm, 3 1/2"
HI-05-294
11 cm, 4"
Straight

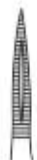

HI-05-295
10.5 cm, 4"
Straight



HI-05-296
10.5 cm, 4"
Curved



HI-05-297
10.5 cm, 4"
Straight



HI-05-298
10.5 cm, 4"
Curved



Feilchenfeld Forceps

Hunter Forceps

Hunter Forceps

Carmalt Forceps

Carmalt Forceps

SPLINTER FORCEPS



Splitterpinzetten
Pinzas Para espinas

Pinces à échardes
Pinze per scheggie



Splinter Forceps

HI-05-299 8.0 cm, 3"
HI-05-300 9.0 cm, 3 1/2"
HI-05-301 10.5 cm, 4"
HI-05-302 11.5 cm, 4 1/2"
HI-05-303 12.5 cm 5"
HI-05-304 14.5 cm 5 1/2"
Straight serrated with
guide pin



Splinter Forceps

HI-05-305 8.0 cm, 3"
HI-05-306 9.0 cm, 3 1/2"
HI-05-307 10.5 cm, 4"
HI-05-308 11.5 cm, 4 1/2"
HI-05-309 12.5 cm 5"
HI-05-310 14.5 cm 5 1/2"
Curved serrated with
guide pin



Splinter Forceps

HI-05-311 8.0 cm, 3"
HI-05-312 9.0 cm, 3 1/2"
HI-05-313 10.5 cm, 4"
HI-05-314 11.5 cm, 4 1/2"
HI-05-315 12.5 cm 5"
HI-05-316 14.5 cm 5 1/2"
Straight plain with
guide pin



Splinter Forceps

HI-05-317 8.0 cm, 3"
HI-05-318 9.0 cm, 3 1/2"
HI-05-319 10.5 cm, 4"
HI-05-320 11.5 cm, 4 1/2"
HI-05-321 12.5 cm 5"
HI-05-322 14.5 cm 5 1/2"
Curved plain with
guide pin



Stieglitz Forceps with Magnifying Mirrors

HI-05-323
12.5 cm, 5"

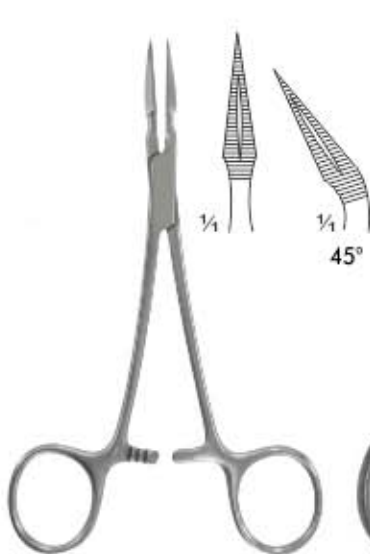

Stieglitz Splinter Forceps

HI-05-324 14 cm, 5 1/2" Str.
HI-05-325 14 cm, 5 1/2" 45° Angled

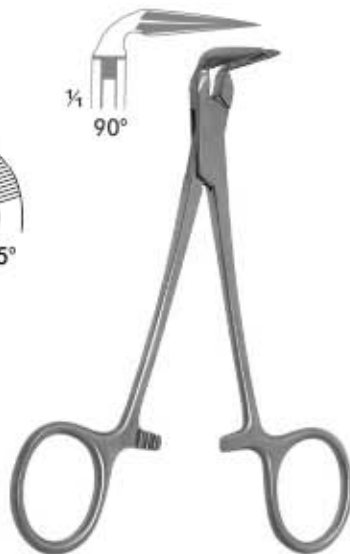

Stieglitz Splinter Forceps

HI-05-326
14 cm, 5 1/4" 90° Angled



Peet Splinter Forceps

HI-05-327
11.5 cm, 4 1/2"

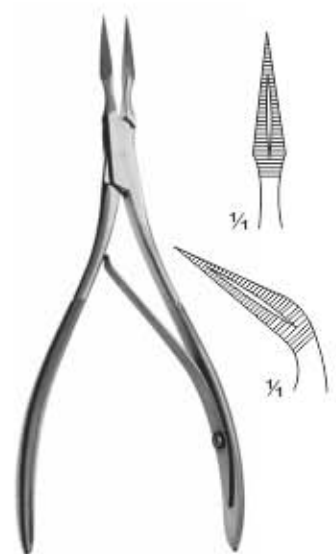

Ralk Splinter Forceps

HI-05-328 15 cm, 6" Str.
HI-05-329 15 cm, 6" Cvd.



Ochsner Forceps
HI-05-330
14 cm, 5 ½"



Lange Tissue Forceps
HI-05-331
10 cm, 4"



Childe Tissue Forceps
HI-05-332
18 cm, 7"



Michel Tissue Forceps
HI-05-333
12 cm, 4 ¾"



Wachenfeldt Tissue Forceps
HI-05-334
12.5 cm, 5"



HEGENBARTH Tissue Forceps
HI-05-335
12.5 cm, 5"



Wachenfeldt Tissue Forceps
HI-05-336
12.5 cm, 5"



Michel Forceps
HI-05-337
12 cm, 4 ¾"



Michel Clips
HI-05-338
sizes: 11mm x 3mm
& 18mm x 3mm.



Mod. Michel Forceps
HI-05-339
12 cm, 4 ¾"



Collin Forceps
HI-05-340
13 cm, 5"

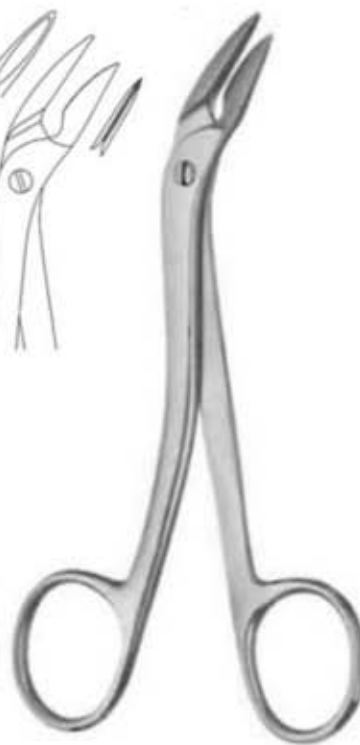

Richter-Heath Forceps
HI-05-341
14 cm, 5 ½"

TISSUE & DRESSING FORCEPS T.C



Pinces a tissu, Anatomische pinzetten
Gewebe, Pinzas de disección

Pinzas para tejidos, Pincas à dissection
Pinze per tessuti, Pinze per dissezione



Micro Adson



Adson



Adson



Micro Adson
Light Weight



Adson
Light Weight



Adson
Light Weight



Micro Adson Tissue Forceps
 1x2 teeth



Adson Tissue Forceps
 1x2 teeth



Adson Tissue Forceps
 3x4 teeth



Micro Adson Light Weight
 1x2 teeth



Adson Light Weight
 1x2 teeth



Adson-Brown Light Weight
 3x4 teeth

TISSUE & DRESSING FORCEPS T.C



Pinces a tissu, Anatomische pinzetten
Gewebe, Pinzas de disección

Pinzas para tejidos, Pinces à dissection
Pinze per tessuti, Pinze per dissezione

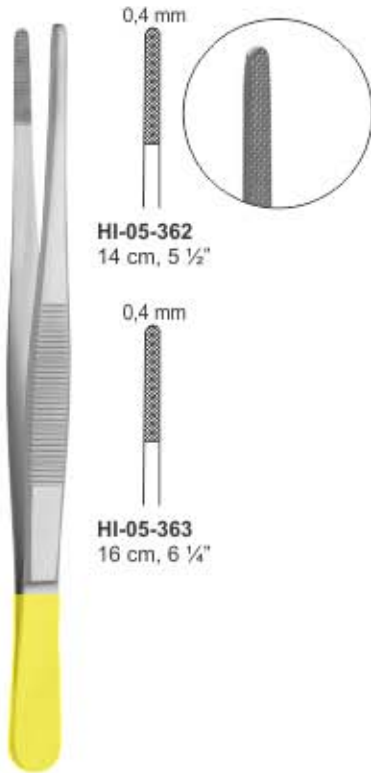

T.C Standard Dressing Forceps



T.C Cushing Tissue Forceps
HI-05-364 17.8 cm, 7"



T.C Cushing Dressing Forceps
HI-05-365 18 cm, 7" Cross Serrated



T.C Cushing Dressing Forceps
HI-05-366 18 cm, 7"



T.C Dissecting Tissue Forceps
HI-05-367 18 cm, 7"



T.C Resano Dressing Forceps
HI-05-368 25 cm, 10"



T.C Cushing Dressing Forceps
HI-05-369 19 cm, 7 1/2"

Pincas a tissu, Anatomische pinzetten
Gewebe, Pinzas de disección

Pinzas para tejidos, Pincas à dissection
Pinze per tessuti, Pinze per dissezione

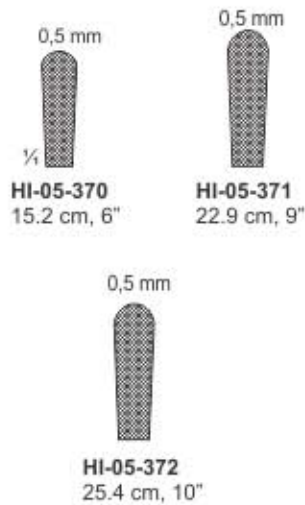

Wangensteen Dressing Forceps T.C.

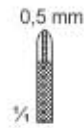

T.C DeBakey Micro Needle Tissue Forceps
HI-05-373
18.4 cm, 7"

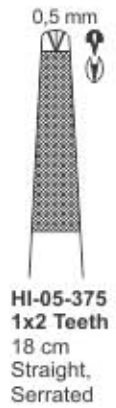
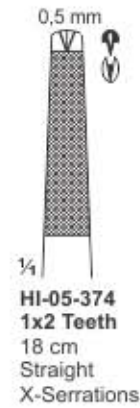

T.C Bonney Dissecting & Tissue Forceps



T.C POTTS-SMITH Dressing Forceps
HI-05-377 15 cm, 6"
HI-05-378 18 cm, 7"
HI-05-379 20 cm, 8"
HI-05-380 23 cm, 9"
HI-05-381 25 cm, 10"



T.C POTTS-SMITH Dressing Forceps
HI-05-382 16 cm, 6 1/2"
HI-05-383 18 cm, 7"
HI-05-384 21 cm, 8 1/2"
HI-05-385 24 cm, 9 1/2"
HI-05-386 26 cm, 10 1/2"



T.C Evans Pelvic Needle Dressing Forceps
HI-05-387
25.4 cm, 10"

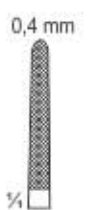

T.C Evans Dressing Forceps
HI-05-388
25 cm, 10"

DRESSING FORCEPS T.C.



Anatomische pinzetten
Pinzas de disección

Pinces à dissection
Pinze per dissezione



T.C Mc Indoe Dressing Forceps
HI-05-389
15.0 cm 6"



T.C De Bakey Dressing Forceps
HI-05-390 15.0 cm 6"
HI-05-391 19.0 cm 7 1/2"
HI-05-392 24.0 cm 9 1/2"



T.C Gillies Tissue Forceps
HI-05-393
15.0 cm 6"



SEMKEN
with dissector end



SEMKEN
1x2 teeth

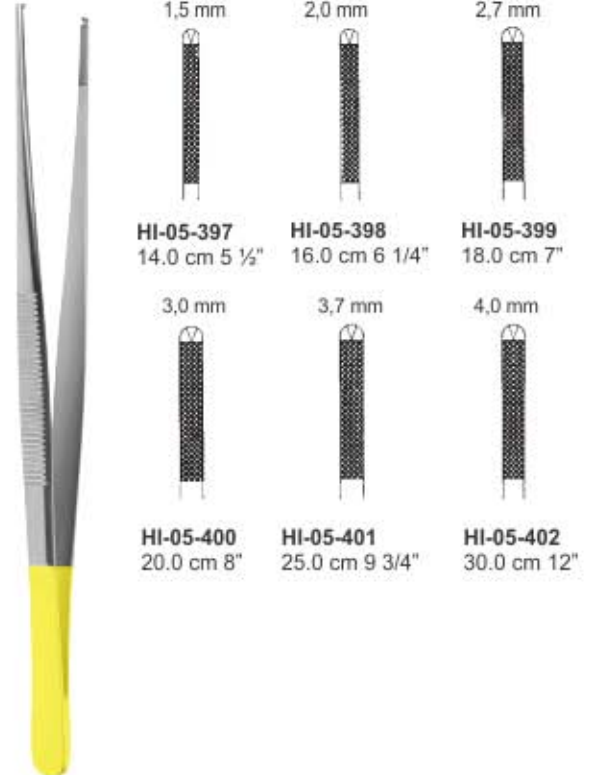

T.C Oehler Tissue Forceps

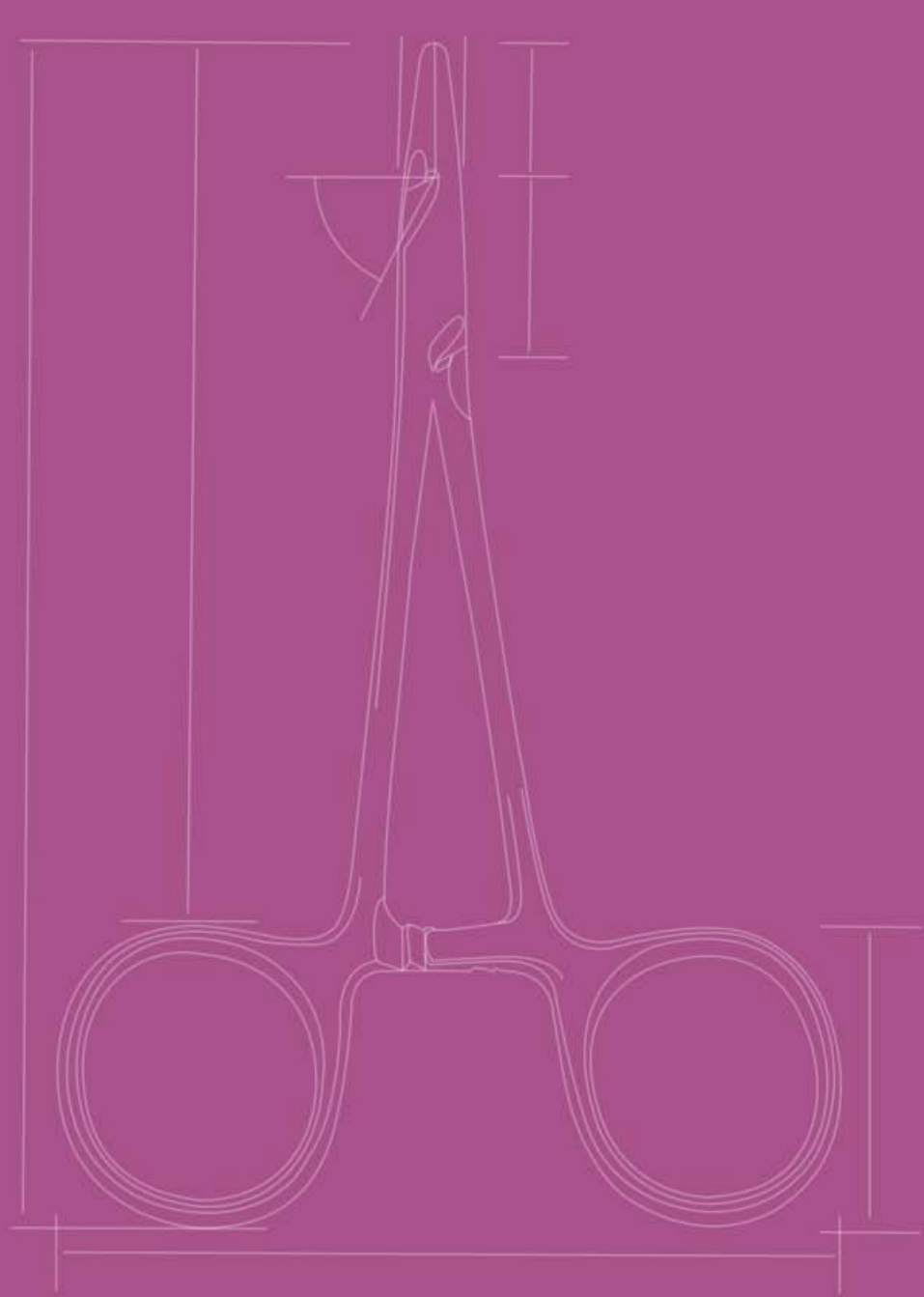

HOMEDICA
INTERNATIONAL