

Surgical Instruments Catalogue

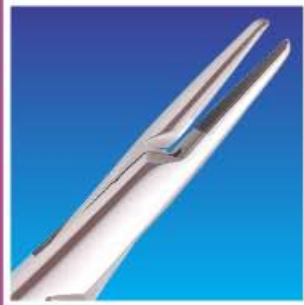

HOMEDICA
INTERNATIONAL



HOMEDICA INTERNATIONAL

Homedica feels great honor introducing itself to be one of the leading manufacturing company of surgical & dental instruments. Professional always prefer Homedica instruments, which is our pride.

Our all instruments are manufactured by the high quality stainless steel made on our requirements, every instrument is hand crafted with the highest workmanship available in the industry. Through heat treatment, the instruments are hardened and tempered for proper functioning and long life. All instruments are polished electrolytically and manually for maximum resistance to corrosion and long life. Homedica pays special attention to the needs of doctors, with innovative designs to meet the needs of professionals. The wide assortment of standard patterns and exclusive Homedica designs gives you the most desirable range of surgical and dental instruments.

Over the several years, we have earned the reputation of for maintaining highest quality standards of quality and service. To manufacture instruments that meet with your changing demands is our achievement. Our highly skilled staff of professionals will continue to serve your needs and will try their outmost to uplift the standards which we have set in the past.

With your co-operation and guidance, Homedica will continue serving surgical and dental instruments in future.

Management of Homedica international

BASIC METHODS FOR HANDLING AND CARE OF SURGICAL AND DENTAL INSTRUMENTS

Dear Customers:

We have received some questions concerning staining, pitting or rusting in stainless steel instruments. So, we took great honour and pleasure in guiding our respected customers to eliminate the problems about staining or rusting etc. The points are as follows:-

- 1) Rinse the instruments as soon as possible after use to remove blood and serum.
- 2) Dry the instruments after cleaning or before wrapping and storing, if not so, moisture left can cause rust and corrosion.
- 3) Do not leave instruments in cold sterilization solution for a long period, as the solution may lead the instrument to be corrosive.
- 4) Never use caustic cleaners, use those specified for cleaning surgical instruments.
- 5) Avoid cleaning instruments with steel wool; if want to clean with hand, use detergent soap and a soft brush and finally treat with distilled water.
- 6) You should check your autoclave; Iron, calcium, sodium or copper in water can cause rusting, staining or corrosion.
- 7) Leaving of instruments for a long time in the following solutions can also cause corrosion.
 - i) Phenol or Iodine.
 - ii) Aluminium, Barium or Calcium.
 - iii) Any Acid, Mercury or Potassium solution.
- 8) Try your utmost not to sterilize stainless steel instrument with chrome plated brass instruments, as any break in chrome surface may cause pitting or rusty surface in instruments.
- 9) Muslin wraps should be rinsed sufficiently by the laundry, so that all chlorine bleach may remove, which can cause corrosion or custing during autoclaving.

We hope that by acting on the above instructions, your problems relating to rusting, staining or pitting would abolish and the age of your instrument would increase.

MANAGEMENT

DIAGNOSTIC INSTRUMENTS



STETHOSCOPES

Stethoskope | Estetoscopios
Stéthoscopes | Stetoscopi



DUPLEX, Stethoscope
HI-01-001
super lightweight



DUPLEX-BABY
Stethoscope
HI-01-002
super lightweight



ANAESTOPHON
Stethoscope
HI-01-003
super lightweight



PINARD WOODEN
Stethoscope
HI-01-004
18 cm, 7"



PINARD ALUMINIUM
Stethoscope
HI-01-005
15 cm, 6"



WEBER
Aesthesiometer
HI-01-006
9.0 cm, 3 1/2"

PERCUSSION HAMMERS

Perkussionshämmer | Martillos de percusión
 Marteaux-percuteurs | Martelli percussori



NEURO-DUOFLEX Hammer
 HI-01-007 22 cm, 8 3/4"



DEJERINE Hammer
 HI-01-008 20 cm, 8"

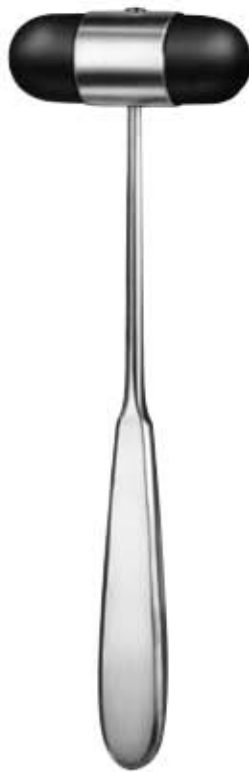

DEJERINE Hammer
 HI-01-009 20 cm, 8"



TROEMNER Hammer
 HI-01-010 145 g
 HI-01-011 175 g
 HI-01-012 235 g
 24.5 cm, 9 1/2"
 spare rubber



TROEMNER-SIMPLEX Hammer
 HI-01-013 21 cm, 8 1/4"



BUCK Hammer
 HI-01-014 18.5 cm, 7 1/4"



BUCK Hammer
 HI-01-015 18 cm, 7"



TAYLOR Hammer
 HI-01-016 18 cm, 7"
 HI-01-017 20 cm, 8"



TAYLOR Hammer
 HI-01-018 18 cm, 7"

PERCUSSION HAMMERS

Perkussionshämmer | Martillos de percusión
 Marteaux-percuteurs | Martelli percussori



¼

BABINSKY Hammer
 HI-01-019 22 cm, 8 ¾"
 Ø 40mm



¼

BABINSKY Hammer
 HI-01-020 22 cm, 8 ¾"
 Ø 40mm



¼

RABINER Hammer
 HI-01-021 23 cm, 9"
 Ø 40mm
 with needle & brush



BERLINER Hammer
 HI-01-022 20.0 cm, 8"

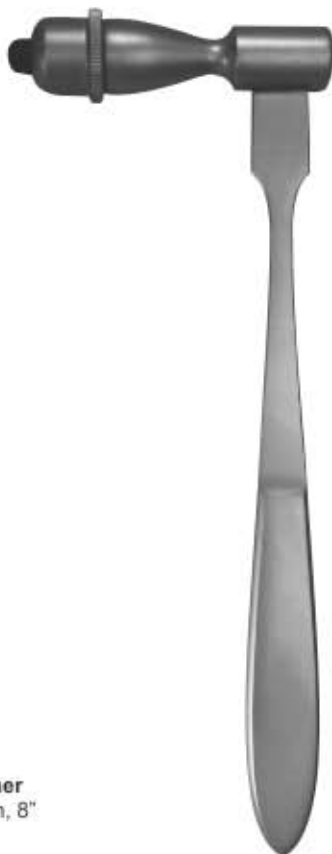

TRAUBE Hammer
 HI-01-023 16 cm, 6 ¼"



**WARTENBERG
 Pinwheel**
 HI-01-024 19 cm, 7 ½"

CATHETER FORCEPS

Katheterzangen

Pinzas para catéteres

Pinzas para sondes

Pinze per cannule



MAGILL
Catheter Intubating
Forcep
HI-01-025 16 cm, 6 1/4"



MAGILL
Catheter Intubating
Forcep
HI-01-026 20 cm, 8"



MAGILL
Catheter Intubating
Forcep
HI-01-027 25 cm, 10"



MAGILL Catheter Intubating Forcep GOLD
HI-01-028 6.5" (2.5" shaft) , Infant , hole (dia 2.00 mm)
HI-01-029 7.5" (3" shaft) , Infant , hole (dia 2.30 mm)
HI-01-030 7.5" (4" shaft) , Infant , hole (dia 2.60 mm)



MAGILL Catheter Intubating Forcep GOLD
HI-01-031 8" (4" shaft) , Child , hole (dia 3.00 mm)
HI-01-032 8" (4" shaft) , Child , oval tip (5.38 mm X 4.15 mm)
HI-01-033 9" (5" shaft) , Adult , oval (6.80 mm x 5.00 mm)
HI-01-034 10" (5" shaft) , Adult , oval (9.60 mm x 7.70 mm)

MC-INTOSH FIBER OPTIC LARYNGOSCOPE BLADE (English Pattern)

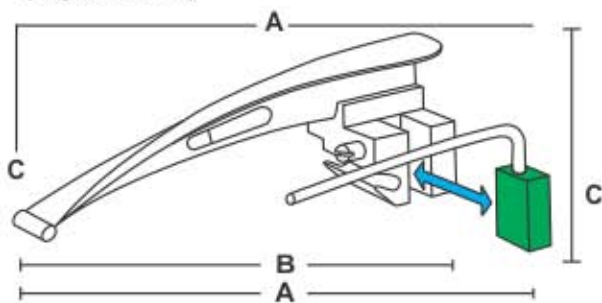

BLADE

Size	A	B	C	Working Length
0	77mm	53mm	14mm	55mm
1	95mm	72mm	43mm	70mm
2	111mm	86mm	44mm	78mm
3	133mm	109mm	44mm	108mm
4	151mm	129mm	44mm	133mm

Mc-Intosh Laryngoscope Fiber Optic

Halogen illumination. Manufactured from AISI 304 Stainless-Steel. Halogen illumination 2.5 V. The Bulb is inside the handle in order to simplify the sterilization of the blades. All blades and handles are interchangeable with other leading manufacturer. All sets can be combined as per your request, and delivered in Green plastic case.

Blades Availability:

- * Matt Finish
- * Mirror Finish
- * Sand Blast Finish
- * Pls, confirm in your order list



Laryngoscope Battery
Handle for Adult
C type 2 batteries

MC-INTOSH FIBER OPTIC LARYNGOSCOPE SET HALOGEN ILLUMINATION

**HI-01-035
PEDIATRIC SET**
Set of 0,1,2
Blades
Supplied in
Green plastic case

**HI-01-036
STANDARD SET**
Set of 1,2,3
Blades
Supplied in
Green plastic case

**HI-01-037
ADULT SET**
Set of 1,2,3,4
Blades
Supplied in
Green plastic case

Fig. 0

Fig. 1

Fig. 2

Fig. 3

Fig. 4



Mc-Intosh Fiber Optic Laryngoscope Set
Halogen Illumination
Manufactured by AISI:
304 Stainless Steel Material

LARYNGOSCOPES

Laryngoskope | Laringoscopios
Laryngoscopes | Laringoscopi



MC-INTOSH LARYNGOSCOPE

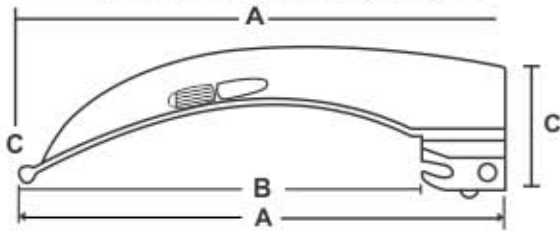

BLADE

Size	A	B	C	Working Length
0	80mm	58mm	30mm	55mm
1	97mm	76mm	36mm	70mm
2	111mm	88mm	36mm	78mm
3	133mm	112mm	36mm	108mm
4	154mm	131mm	38mm	133mm

Mc-Intosh Laryngoscope

Plastic case, Standard illumination. Manufactured from AISI 304 Stainless Steel Matt Type, Standard Illumination 2.5 V. All blades and handles are interchangeable with other leading manufacturer. All sets can be combined as per your request, and delivered in Gray plastic case.

Blades Availability:

- ★ Matt Finish
- ★ Mirror Finish
- ★ Sand Blast Finish
- ★ Pls, confirm in your order list

Conventional Laryngoscope Set

Mc-INTOSH LARYNGOSCOPE SET STANDARD ILLUMINATION

AVAILABLE SETS
WITH
BATTERY HANDLE

**HI-01-038
PEDIATRIC SET**
Set of 0,1,2
Blades
Supplied in
Gray plastic case

**HI-01-039
STANDARD SET**
Set of 1,2,3
Blades
Supplied in
Gray plastic case

**HI-01-040
ADULT SET**
Set of 1,2,3,4
Blades
Supplied in
Gray plastic case

Fig. 0

Fig. 1

Fig. 2

Fig. 3

Fig. 4



Laryngoscope Battery
Handle for Adult
C type 2 Batteries



With two Spare
Bulbs



Mc-Intosh Laryngoscope Set
Standard Illumination
Manufactured From
Stainless Steel Material

LARYNGOSCOPE MILLER

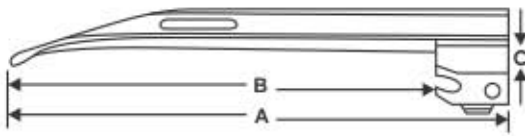

BLADE

Size	A	B	C	Working Length
0	75mm	53mm	26mm	55mm
1	111mm	80mm	26mm	80mm
2	151mm	134mm	28mm	130mm
3	188mm	167mm	28mm	170mm
4	203mm	180mm	28mm	180mm

Mc-Intosh Laryngoscope

Plastic case, Standard illumination.
Manufactured from AISI 304 Stainless Steel.
All blades and handles are interchangeable
with other leading manufacturer. All sets
can be combined as per your request, and
delivered in Blue plastic case.

Blades Availability:

- * Matt Finish
- * Mirror Finish
- * Sand Blast Finish
- * Pls, confirm in your order list

Conventional Laryngoscope Set

LARYNGOSCOPE SET OF CONVENTIONAL MILLER STANDARD ILLUMINATION

AVAILABLE SETS WITH BATTERY HANDLE

HI-01-041 PEDIATRIC SET
Set of 0,1,2
Blades
Supplied in
Blue plastic case

HI-01-042 STANDARD SET
Set of 1,2,3
Blades
Supplied in
Blue plastic case

HI-01-043 ADULT SET
Set of 1,2,3,4
Blades
Supplied in
Blue plastic case



Fig. 1



Fig. 2



Fig. 3



Fig. 4



Laryngoscope Battery Handle for Adult C type
2 batteries



With two Spare Bulbs



Laryngoscope Set of conventional Miller
Standard Illumination
Manufactured From Stainless Steel Material

DIAGNOSTIC SETS

Diagnostik-Bestestecke | Juegos para diagnóstico
 Trousses à diagnostic | Astucci per diagnostica



**Professional Otoscope & Ophthalmology Set
 ENT Medical Diagnostic Set**

HI-01-044

2.5 V Standard illumination for use with 2 batteries C type.
 Including:
 Otoscope Head: Luir Lock fitting.
 Chrome plated.
 Fix lens 4 x in plastic mount can be removed for introduction of instruments.
 Specula sizes: 2.5, 3.5 & 4.5 mm Included,
 Ophthalmoscope head: Luir Lock fitting.
 Lens selection wheel permits choice of corrective lenses from 0 to - 20 and 0 to +20 diopters.
 Single large circle aperture.
 Bent-arm illuminator: pin contact fitting.
 Nasal speculum: Chrome plated.
 Two laryngeal mirrors: n. 4 and 5.
 Battery handle: 28mm. For 2 cell C-batteries.
 Chrome plated. For adjustment of all illumination.
 Replacement bulb: 2.5 V
 Diagnostic set is supplied in our new beautiful look and quality Blue Case, which protect our quality Products from moisturizing and damaging.



Handle



Two laryngeal mirrors: n. 4 and 5



Bent-arm illuminator:
 pin contact fitting.



Specula



With 2 spare Bulbs



Otoscope Head



Nasal speculum: Chrome plated.



Ophthalmoscope head



ENT Specula



DIAGNOSTIC PENTOSCOPE SET

HI-01-045

2.5 V Standard illumination for use with 2 batteries type AA.

Consisting:

Universal Handle thread type fit for all Pentoscope Heads like.

- Otoscope Head.
- Ophthalmoscope Head.
- Throat Branch Head.
- Mouth Mirrors Head.

It have two exploring mirrors No. 4 & 5 mm.

Its spare 06 disposable Plastic ear Canulas are with sizes 2 x 2.50 mm, 2 x 3.50 mm & 2 x 4.5 mm.

On special order it can be as 2 x 1.5 mm for new born babies 2 x 2.5 mm for pediatric and 2 x 4 mm for adults, so it means total 06 canula also available in a plastic tube packing.

Sturdy adjustment mount bracket

2 spare 2.5 V bulb.

Pentoscope set battery handle is operating with two AA size batteries.

This Pentoscope set Packed in our new beautiful Blue Colour plastic case in same blue inner packing material.

Spare parts also available of any item.



With 2 spare Bulbs



Mouth Mirrors Head



Standard illumination



Otoscope Head



Sturdy Adjustment Mount Bracket



Plastic ear Canulas

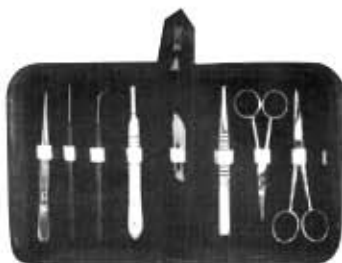

HI-01-046

Dissecting Set of 9 Pcs.

- Dissecting Forceps 11.5cm Sharp Point.
- Teasing needle Sharp STR.
- Teasing Needle Sharp Angular.
- B.P Handle No.4.
- Blade No. 22.
- Thumb Forcep T.O.E 13cm.
- Dissecting Scissor STR 11.5cm.
- Dissecting Scissor STR 13cm.
- Zipper Case Inside Red Velvet.

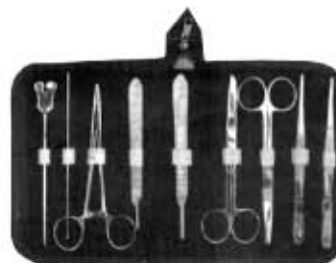

HI-01-047

Dissecting Set of 10 Pcs.

- Grooved Director with Tongue Tie 14cm.
- Probe Double 14cm.
- Mayo Hegar Needle Holder 14cm.
- B.P Handle No.3
- B.P Handle No.4
- Dressing Scissor 14cm S/B STR.
- Dressing Scissor 14cm S/B CVD.
- Dressing Forcep 1x2 teeth 14cm.
- Dressing Forcep Serrated 14cm.
- Zipper Case Inside Red Velvet.



HI-01-048

Dissecting Set of 10 Pcs.

- Probe Double 13cm.
- 2PCS. Scalpel S.S.
- Grooved Director With Tongue Tie 14cm
- Mayo Hegar Needle Holder 14cm.
- Dissecting Forceps 14cm 1x2 Teeth.
- Dressing Forceps 14cm Serrated.
- Dressing Scissor 14cm S/B STR.
- Dressing Scissor 14cm S/B CVD.
- Zipper Case Inside Red Velvet.



HI-01-049

Dissecting Set of 10 Pcs.

- Blow Pipe.
- 3PCS Scalpel.
- Dissecting Forceps 14cm.
- Grooved Director With Tongue Tie 14cm
- Triple Chain Hook.
- Dressing Scissor Probe Pointed 14cm.
- Probe Double 14 cm.
- Zipper Case Inside Red Velvet.



Dissecting Set

HI-01-050 Containing 9 Instruments

- slice Needle
- Probe Butterfly
- Needle Holder
- Scalpel Handle 3
- Scalpel Handle 4
- Dressing Forceps
- Tissue Forceps
- Tonsil Scissors
- Dressing Scissors

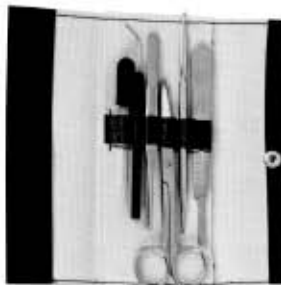

HI-01-051

Dissecting Set of 6 pcs.

- Dropper Oil
- Probe Plastic Handle
- Dressing Forceps
- Dressing Scissors S/s
- Hook
- Scalpel Handle 4

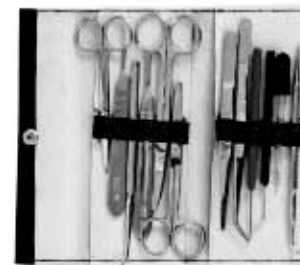

HI-01-052

Dissecting Set of 12 pcs.

- Iris Scissors
- Scalpel Knives 4
- Probe Single Ended
- Scalpel Handle 3
- Dressing Scissors S/s
- Dressing Scissors S/b
- Dressing Forceps
- College Tweezer
- Probe Straight Plastic Handle
- Probe Angular Plastic Handle
- Dropper Owl
- Hook



HI-01-053

- 1- Probe with eye
- 2- Dissecting Forcep CVD Fine 12 cm.
- 3- Iris Scissor
- 4- Operating Scissor S/B STR 14 cm
- 5- Grooved Director and Tongue tie
- 6- Huber Probe
- 7- Triple Chain Hook
- 8- B.P. Handle No. 4
- 9- B.P. Handle No. 3
- 10- Teasing Needle with Chuck CVD.
- 11- Teasing Needle with Chuck STR.
- 12- Dissecting Forceps Fine 14 cm.



HI-01-054

- 1- Teasing Needle STR.
- 2- Grooved Director and Tongue Tie.
- 3- Teasing Needle CVD.
- 4- Dissecting Forcep with Pin 12 cm Fine
- 5- Operating Scissor S/B STR 14 cm
- 6- Triple Chain Hook
- 7- Probe with eye
- 8- Probe Double end
- 9- Probe and Hook
- 10- Dissecting Forcep Fine 14 cm
- 11- Iris Scissor
- 12- Huber Probe
- 13- B.P. Handle No.3
- 14- B.P. Handle No.4

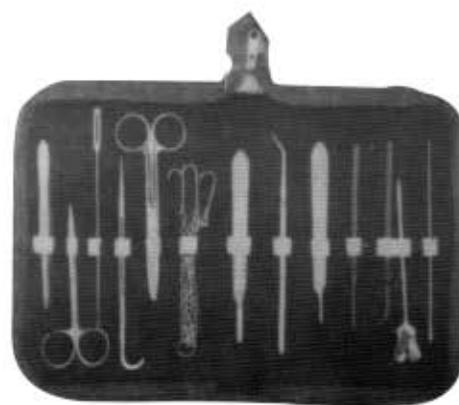

HI-01-055

- 1- Dissecting Forcep Fine STR with pin 12cm.
- 2- Iris Scissor STR.
- 3- Probe with eye.
- 4- Probe and Hook.
- 5- Operating Scissor S/B STR 14cm
- 6- Triple Chain Hook.
- 7- B.P. Handle No.4
- 8- Humber Probe.
- 9- B.P. Handle No.3
- 10- Teasing Needle STR Plastic Handle.
- 11- Teasing Needle CVD Plastic Handle.
- 12- Grooved Director and Tounge Tie.
- 13- Probe Double end.

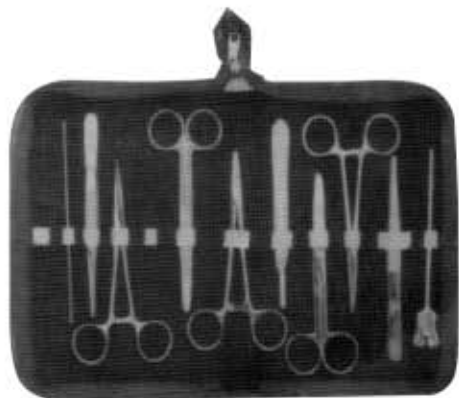

HI-01-056

- 1- Dissecting Forceps Thumb 14 cm.
- 2- Dissecting Forcep 1x2 Teeth 14 cm.
- 3- B.P. Handle No. 3
- 4- Grooved Director and Tongue tie
- 5- Mayo Hegar Needle Holder 14 cm
- 6- Operating Scissor S/B STR 14 cm
- 7- Probe Double end
- 8- Kelly Forcep STR 14 cm.

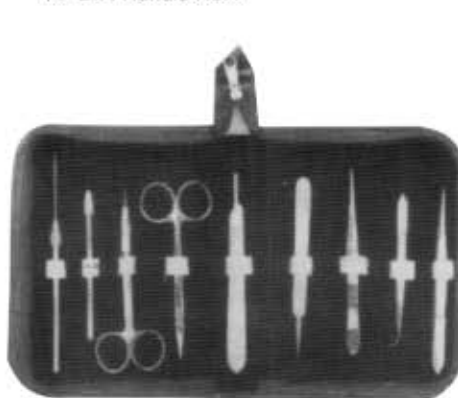

HI-01-057

- 1- Dissecting Forcep Fine 14cm.
- 2- Dissecting Forcep Fine CVD 12cm
- 3- Dissecting Forcep with Pin 14cm.
- 4- Watchmaker Fine point
- 5- Iris Scissor STR
- 6- Iris Scissor CVD.
- 7- Teasing Needle Holder
- 8- Teasing Needle STR.
- 9- B.P. Handle no. 3



HI-01-058

- 1- Probe Double end
- 2- B.P. Handle No. 4
- 3- Dissecting Forcep 1x2 Teeth 14 cm.
- 4- Operating Scissor S/B STR 14 cm
- 5- Mayo Hegar Needle Holder 14 cm
- 6- Kelly Forcep STR 14 cm.
- 7- Operating Scissor S/B CVD 14 cm
- 8- Grooved Director and Tongue tie
- 9- Dissecting Forceps Thumb 14 cm.

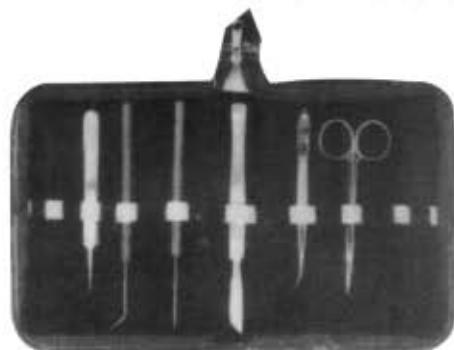

HI-01-059

- 1- Iris Scissor STR
- 2- Dissecting Forceps CVD 12 cm.
- 3- Scapel
- 4- Teasing Needle STR wooden Handle.
- 5- Teasing Needle CVD wooden Handle.
- 6- Watchmaker fine point.

Diagnostik-bestecke

Diagnostic Setts

Estuches de diagnostico

Combinazioni per diagnostica

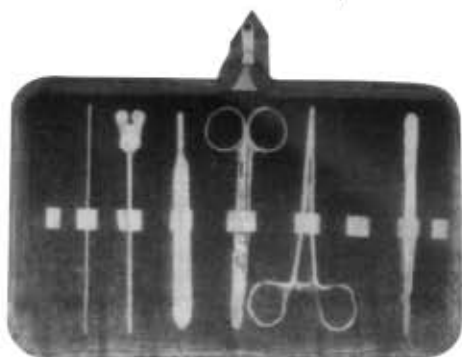

HI-01-060

- 1- Probe Double end.
- 2- Grooved Director and Tounge tie
- 3- B.P. Handle No. 4
- 4- Operating Scissor STR S/B 14 cm.
- 5- Kelly Forceps STR 14 cm.
- 6- Dissecting Forceps Thumb 13 cm.

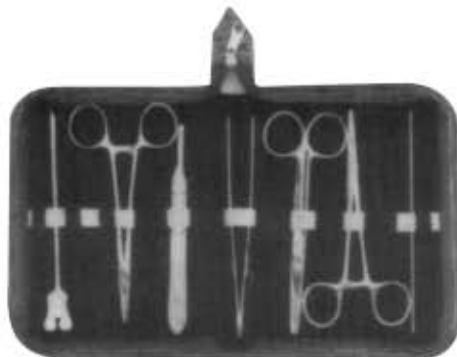

HI-01-061

- 1- Grooved Director and Tongue tie
- 2- Mayo Hegar Needle Holder 14 cm
- 3- B.P. Handle No. 4
- 4- Dissecting Forceps Thump 14 cm.
- 5- Operating Scissor S/B STR 14 cm
- 6- Kelly Forcep STR 14 cm.
- 7- Probe Double end

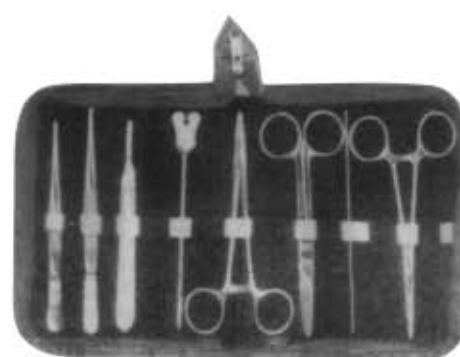

HI-01-062

- 1- Dissecting Forceps Thumb 14 cm
- 2- Dissecting Forcep 1x2 Teeth 14 cm.
- 3- B.P. Handle No. 3
- 4- Grooved Director and Tongue tie
- 5- Mayo Hegar Needle Holder 14 cm
- 6- Operating Scissor S/B STR 14 cm
- 7- Probe Double end
- 8- Kelly Forcep STR 14 cm.

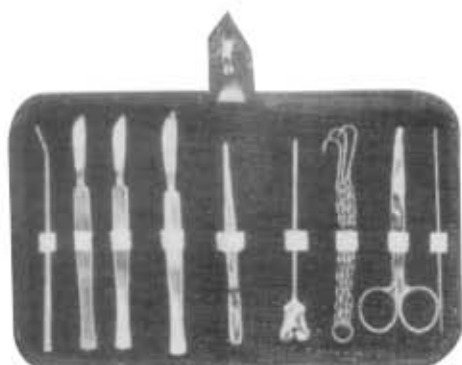

HI-01-063

- 1- Blow pipe.
- 2- 3 PCS Scalpel.
- 3- Dissecting Forcep 13 cm.
- 4- Grooved Director with Tounge tie 13 cm.
- 5- Triple Chain Hook.
- 6- Dressing Scissors probe pointed 13 cm.
- 7- Probe Double 13 cm.
- 8- Zipper Case inside red velvet.

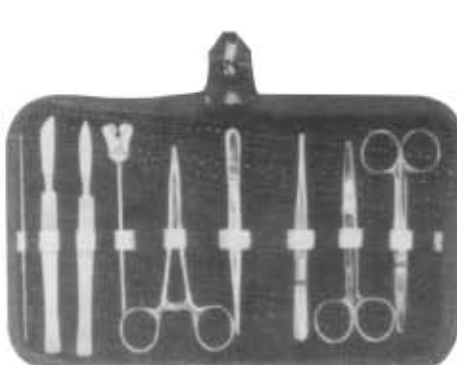

HI-01-064

- 1- Probe Double 13 cm
- 2- 2 PCS. Scalpel S.S
- 3- Grooved Director with Tongue Tie 13 cm
- 4- Mayo Hegar Needle Holder 13 cm
- 5- Dissecting Forcep 13 cm 1x2 Teeth
- 6- Dressing Forcep 13 CMS Serrated.
- 7- Dressing Scissor 13 cm S/B STR.
- 8- Dressing Scissor 13 cm S/B CVD.
- 9- Zipper Case Inside Red Velvet.

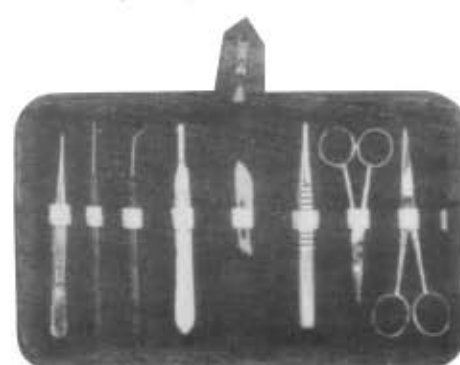

HI-01-065

- 1- Dissecting Forcep 11.5 cm Sharp Point.
- 2- Iris Scissor
- 3- B.P. Handle No. 4
- 4- Teasing Needle Sharp angular.
- 5- Blade No. 22
- 6- Thumb Forceps T.O.E 13 cm
- 7- Dissecting Scissor STR 11.5 cm
- 8- Dissecting Scissor STR 13 cm
- 9- Zipper case Inside Red Velvet

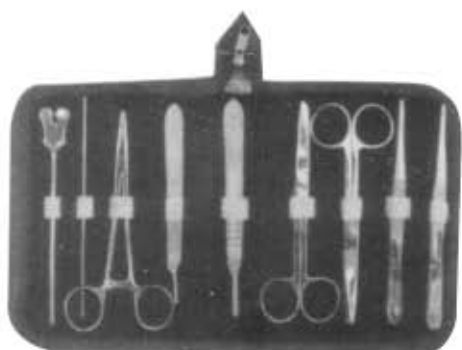

HI-01-066

- 1- Grooved Director with Tongue Tie 14 cm
- 2- Probe Double 14 cm
- 3- Mayo Hegar Needle Holder 14 cm
- 4- B.P. Handle No. 3
- 5- B.P. Handle No. 4
- 6- Dressing Scissor 14 cm S/B STR
- 7- Dressing Scissor 14 cm S/B CVD.
- 8- Dressing Forcep 1x2 Teeth 14 cm
- 9- Dressing Forcep Serrated 14 cm

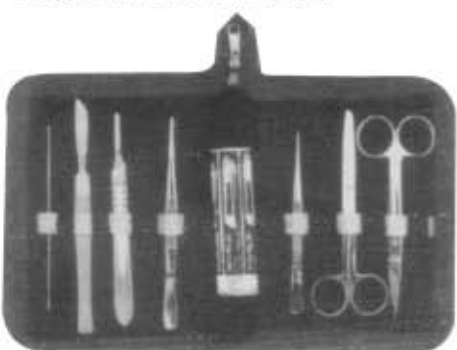

HI-01-067

- 1- Probe Double 12.5 cm
- 2- Scalpel
- 3- B.P. Handle No. 4
- 4- 6 PCS Blade 2 Each No. 21, 22, 23
- 5- Dissecting Forcep 12.5 cm
- 6- Dissecting Forcep 11.5 cm Sharp Point
- 7- Dissecting Scissor S/B STR 13 cm
- 8- Dissecting Scissor S/S STR 13 cm



HI-01-068

- 1- Teasing Needle with Chuck CVD..
- 2- Huber Probe
- 3- Iris Scissor
- 4- Dissecting Forcep Fine 14 cm.
- 5- Dissecting Forcep Fine CVD. 12 cm
- 6- Operating Scissor with Probe 14 cm.
- 7- B.P. Handle No. 4



HI-01-069
15 cm, 6"
cm & mm
markings

**GRADUATED
METAL RULER**



**JAMESON
CALIPER**
HI-01-070
8 cm, 3"



**TOWNLEY
CALIPER**
HI-01-071
10 cm, 4"



**MÖELTGEN
CALIPER**
HI-01-072



**CAROLL
POCKET GONIOMETER**
HI-01-073
14.5 cm, 5 3/4"



**BERTILLON
MEASURING DEVICE**
HI-01-074
32cm 12 1/2"

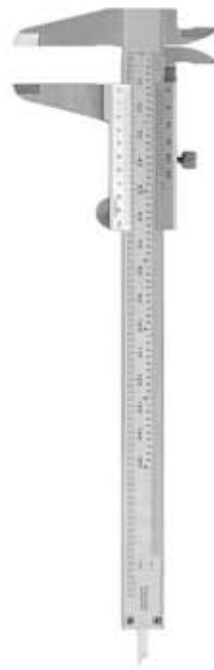

VERNIER CALIPER
HI-01-075
15 cm, 6"



VERNIER CALIPER
HI-01-076
15 cm, 6"
Fine Point



CASTROVIEJO-EPKER
Caliper
HI-01-077 9 cm, 3 1/2", Str.
Measuring range, 40 mm
HI-01-078 9 cm, 3 1/2", Cvd.
Measuring range, 40 mm



CASTROVIEJO-EPKER
Caliper
HI-01-079
18 cm, 7"
Measuring range
40 mm, straight



CASTROVIEJO-EPKER
Caliper
HI-01-080
18 cm, 7" Angled
Measuring range
40 mm



CASTROVIEJO
HI-01-081
Bone Caliper 7"
Straight



CASTROVIEJO
HI-01-082
Bone Caliper 7"
Curved



CASTROVIEJO, Left
HI-01-083 8 cm, 3", Str.
Eye View Caliper
Measuring range, 20 mm
HI-01-084 8 cm, 3", Cvd.
Measuring range, 20 mm



CASTROVIEJO, Right
HI-01-085
8 cm, 3"
Eye View Caliper
Measuring range
20 mm

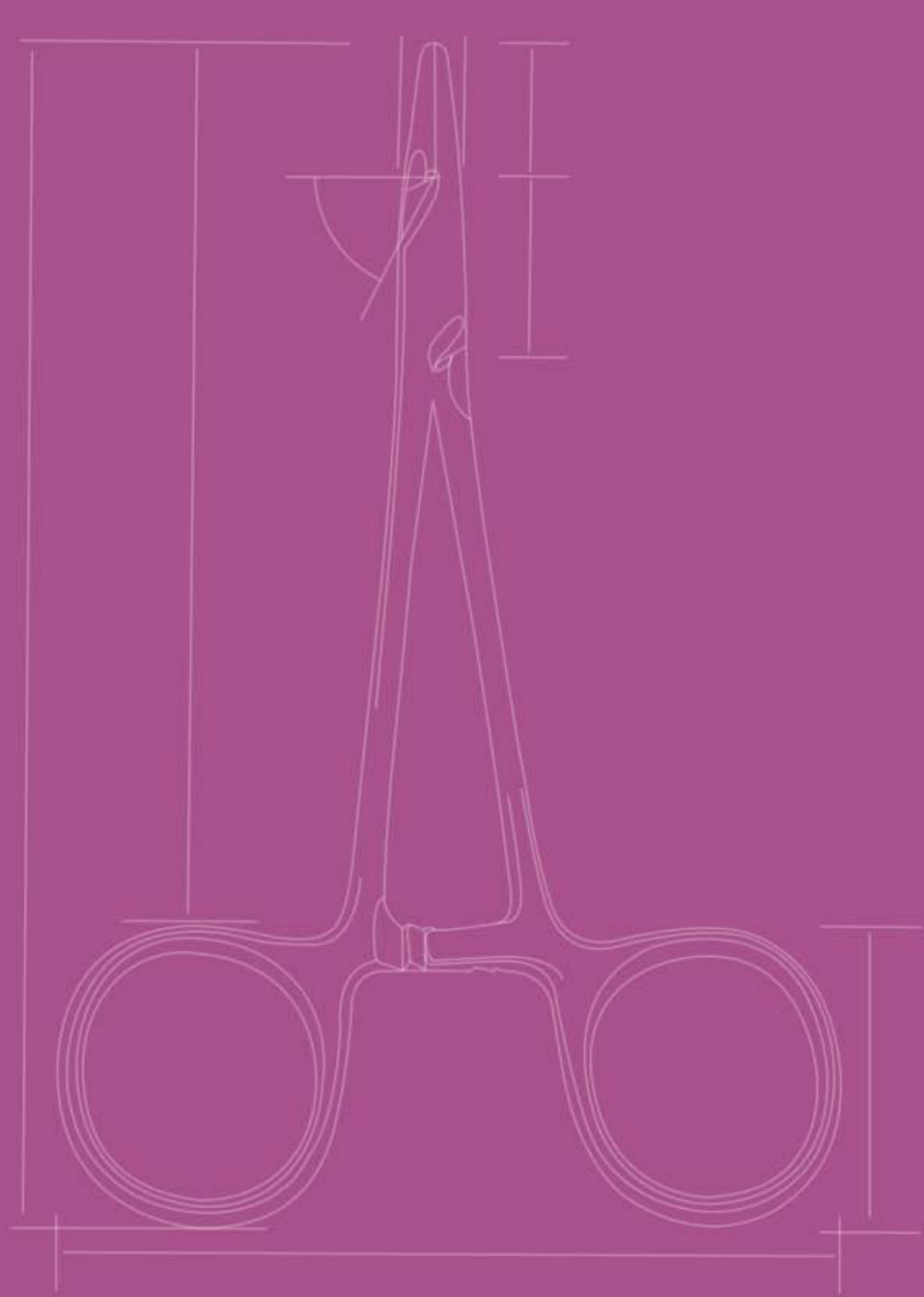

HOMEDICA
INTERNATIONAL