

Surgical Instruments Catalogue

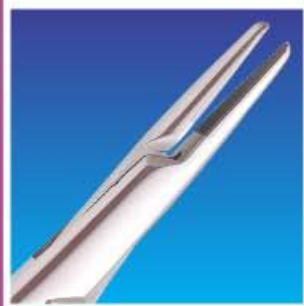

HOMEDICA
INTERNATIONAL

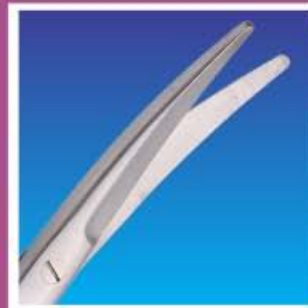

HOMEDICA INTERNATIONAL

Homedica feels great honor introducing itself to be one of the leading manufacturing company of surgical & dental instruments. Professional always prefer Homedica instruments, which is our pride.

Our all instruments are manufactured by the high quality stainless steel made on our requirements, every instrument is hand crafted with the highest workmanship available in the industry. Through heat treatment, the instruments are hardened and tempered for proper functioning and long life. All instruments are polished electrolytically and manually for maximum resistance to corrosion and long life. Homedica pays special attention to the needs of doctors, with innovative designs to meet the needs of professionals. The wide assortment of standard patterns and exclusive Homedica designs gives you the most desirable range of surgical and dental instruments.

Over the several years, we have earned the reputation of for maintaining highest quality standards of quality and service. To manufacture instruments that meet with your changing demands is our achievement. Our highly skilled staff of professionals will continue to serve your needs and will try their outmost to uplift the standards which we have set in the past.

With your co-operation and guidance, Homedica will continue serving surgical and dental instruments in future.

Management of Homedica international

BASIC METHODS FOR HANDLING AND CARE OF SURGICAL AND DENTAL INSTRUMENTS

Dear Customers:

We have received some questions concerning staining, pitting or rusting in stainless steel instruments. So, we took great honour and pleasure in guiding our respected customers to eliminate the problems about staining or rusting etc. The points are as follows:-

- 1) Rinse the instruments as soon as possible after use to remove blood and serum.
- 2) Dry the instruments after cleaning or before wrapping and storing, if not so, moisture left can cause rust and corrosion.
- 3) Do not leave instruments in cold sterilization solution for a long period, as the solution may lead the instrument to be corrosive.
- 4) Never use caustic cleaners, use those specified for cleaning surgical instruments.
- 5) Avoid cleaning instruments with steel wool; if want to clean with hand, use detergent soap and a soft brush and finally treat with distilled water.
- 6) You should check your autoclave; Iron, calcium, sodium or copper in water can cause rusting, staining or corrosion.
- 7) Leaving of instruments for a long time in the following solutions can also cause corrosion.
 - i) Phenol or Iodine.
 - ii) Aluminium, Barium or Calcium.
 - iii) Any Acid, Mercury or Potassium solution.
- 8) Try your utmost not to sterilize stainless steel instrument with chrome plated brass instruments, as any break in chrome surface may cause pitting or rusty surface in instruments.
- 9) Muslin wraps should be rinsed sufficiently by the laundry, so that all chlorine bleach may remove, which can cause corrosion or custing during autoclaving.

We hope that by acting on the above instructions, your problems relating to rusting, staining or pitting would abolish and the age of your instrument would increase.

MANAGEMENT



Charriere Saw
 HI-09-001 35cm 13 3/4"
 Spare saw blades
 HI-09-002 12mm
 HI-09-003 15mm



Charriere Bone Saw Complete
 HI-09-004 35.5cm 14"
 Straight tip, Straight shaft



Helferich-Bier Saw
 HI-09-005 39cm 15 1/2"
 Spare saw blades
 HI-09-006 3mm
 HI-09-007 5mm
 HI-09-008 5mm



Engel Plaster Saw
 HI-09-009 15.5 cm, 6"



Serra Gigli
 HI-09-009 A 30 cm
 HI-09-009 B 40 cm
 HI-09-009 C 50 cm



Percy Amputation Shield
 HI-09-010
 30.5cm 12"
 Handles Detachable,
 Simple Pattern

RASPS, FILES



Raspeln, Feilen
Rapes, Limes

Escofinas, limas
Raspe, lime

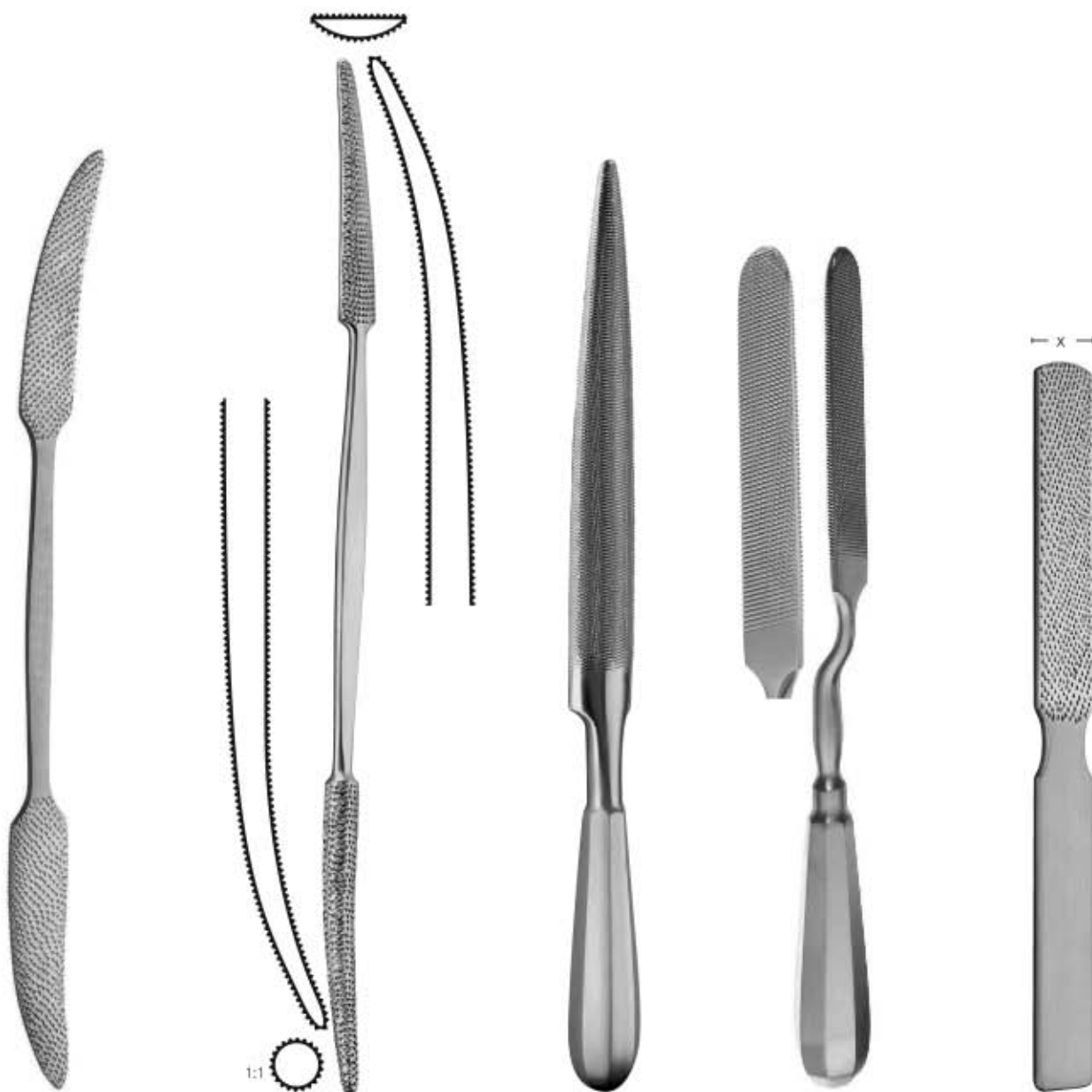

Putti Bone Rasp
HI-09-011
27.0 cm 10 3/4"
Double ended, One end curved up
one end curved sideways

Putti Rasp
HI-09-012
30.0 cm 12"
Double Ended

Putti Bone File
HI-09-013
28.0 cm 11"
semicircular

Putti Bone File
Bayonet Shape
HI-09-014
24.5 cm 9 3/4"
X=13 mm
semicircular

Putti Bone File
HI-09-015
22.0 cm 8 3/4"
X=20 mm
flat

BONE FILES

Knochenfeilen
Limas para huesos

Limes à os
Lime per ossa



Foman Rasp
HI-09-016 21.5cm 8 1/2"
Double ended, Fine & coarse serrations
4-sided convex and flat blades



Foman Rasp
HI-09-017
21 cm, 8 1/2"



Miller-Colburn Bone File
18 cm, 7"



Fig. 1
HI-09-018



Fig. 2
HI-09-019



Fig. 3
HI-09-020



Fig. 4
HI-09-021



cross cut



Kleinert-Kutz Bone Rasp
HI-09-022 22.5cm 8 7/8"
Double ended,
Fine & coarse serrations



Miller Alveotomy File
HI-09-023
19 cm, 7 1/2"



Miller Alveotomy File
HI-09-024
19 cm, 7 1/2"

MALLETS



Hammer
Maillets

Martillos
Martelli



Doyen Mallets
25cm 7 3/4"
HI-09-025 25mmØ - 120g
HI-09-026 30mmØ - 180g
HI-09-027 35mmØ - 260g



Collin Mallets
HI-09-028 20cm 8"
30mmØ - 220g



Hajek Mallets
HI-09-029 21.5cm 8 1/2"
27mmØ - 140g



Kirk Mallets
HI-09-030 19cm 7 1/2"
38mmØ - 750g
HI-09-031 20.4cm 8"
Head diameter 38.0mm,
Weight: 1 lb. 4 oz.
570 grams



Partsch Mallets
HI-09-032 18cm 7"
22mmØ - 200g



Lucae Mallets
HI-09-033 19mmØ - 220g
HI-09-034 25mmØ - 260g
19cm 7 1/2"



Mallet Mallets
HI-09-035 19cm 7 1/2"
250mmØ - 205g
Solid steel, with
plastic faces



Cottle Mallets
HI-09-036 18.5cm 7 1/4"
30mmØ - 240g
1 side flat /
1 side convex



Williger Hammer
HI-09-036 A 250g
HI-09-036 B 350g



Neufield Hammer
HI-09-036C

MALLETS

Hammer
Maillets

Martillos
Martelli



Solid Copper Head Mallet
HI-09-037 16.5cm 6 1/2"
Solid, Head diameter
20mm 3/4"



Nylon Head Mallet
HI-09-038 19.0cm 7 1/2"
Head diameter 25.4mm,
7.76 oz.
HI-09-039 19.5cm 7 5/8"
Head diameter 3cm 1 1/4"
Weight 11 oz.



**Extra 1 1/4" Nylon Face
FOR HI-09-039**
HI-09-040 Head diameter
3cm 1 1/4"



Combination Mallet
HI-09-041 19.5cm 7 5/8"
Solid, Head diameter 32.0mm,
Weight 12 oz 340 grams,
Head weight: 8 oz 227 grams



Bergmann Mallets
HI-09-042
24.5cm 9 3/4"
45mmØ - 300g



Ombredanne Mallets
HI-09-043
24cm 9 1/2"
40mmØ - 550g



Heath Mallets
HI-09-044 18cm 7"
40mmØ - 700g
HI-09-045 20cm 8"
45mmØ - 1000g



Williger Mallets
HI-09-046 28mmØ - 340g
HI-09-047 30mmØ - 400g
24cm 9 1/2"
Lead filled



Hajek Hammer
HI-09-047 A 250gm
HI-09-047 B 500gm



Universal Hammer
HI-09-047 C 500gm
HI-09-047 D 750gm

MALLETS



Hammer
Maillets

Martillos
Martelli



**Nylon Caps Left & Right
FOR HI-09-048 (PAIR)
HI-09-049
1" (2.5cm)**

Mallet, Lightweight
HI-09-048 19.0cm 7 1/2"
Stainless Steel and Aluminum
Head diameter 25.0mm
Weight 7 oz 200 grams
Head Weight: 4 oz 113 grams



Mallet #49
HI-09-050 19.5cm 7 3/4"
Head diameter 22.0mm
Weight 7 oz 200 grams
Head Weight: 5oz/150 grams



Mead Mallet
HI-09-051 19.0cm 7 1/2"
Head diameter 26.0mm
Weight 11 oz 315 grams
Head Weight: 6 oz 170 grams



Heath Mallet, Heavyweight
HI-09-052 19.0cm 7 1/2"
Head diameter 40.0mm
Weight 2 lbs. (907 grams)
Head Weight: 20 oz (567 grams)



Orthopedic Mallet
HI-09-053 27.5cm 10 3/4"
Lightweight
Solid, Head diameter 35.0mm
Weight 2 lbs. (907 grams)
Head Weight: 1 lb. (454 grams)



Orthopedic Mallet
HI-09-054 28.0cm 11"
Heavyweight
Solid, Head diameter 50.0mm
Head Weight: 2 lb. (900 grams)



Ortho Mallets
HI-09-055 26.5 cm 10 1/2"
(450g)



Osteotome
13.5cm 5 1/4"
HI-09-056 8mm
HI-09-057 10mm
HI-09-058 12mm
HI-09-059 14mm
HI-09-060 16mm



Chisel
13.5cm 5 1/4"
HI-09-061 8mm
HI-09-062 10mm
HI-09-063 12mm
HI-09-064 14mm
HI-09-065 16mm



Gouge
13.5cm 5 1/4"
HI-09-066 8mm
HI-09-067 10mm
HI-09-068 12mm
HI-09-069 14mm
HI-09-070 16mm



Lucas Chisel
16cm 6 1/4"
HI-09-071 3mm
HI-09-072 4mm
HI-09-073 5mm
HI-09-074 6mm



Lucas Gouge
16cm 6 1/4"
HI-09-075 3mm
HI-09-076 4mm
HI-09-077 5mm
HI-09-078 6mm



U.S. Army Pattern Chisel
16.5 cm 6 1/2"
HI-09-079 6 mm wide
HI-09-080 12 mm wide
HI-09-081 18 mm wide



Alexander Chisel
18cm 7"
HI-09-082 4mm
HI-09-083 6mm
HI-09-084 8mm
HI-09-085 10mm
HI-09-086 12mm
HI-09-087 14mm



Alexander Gouge
18cm 7"
HI-09-088 4mm
HI-09-089 6mm
HI-09-090 8mm
HI-09-091 10mm
HI-09-092 12mm
HI-09-093 14mm



Partsch Chisel
11.5cm 4 1/2"
HI-09-094 2mm
HI-09-095 3mm
HI-09-096 4mm
HI-09-097 6mm
HI-09-098 7mm
HI-09-099 8mm

Partsch Chisel
13.5cm 5 1/4"
HI-09-100 2mm
HI-09-101 3mm
HI-09-102 4mm
HI-09-103 6mm
HI-09-104 7mm
HI-09-105 8mm

Partsch Chisel
17.5cm 6 3/4"
HI-09-106 2mm
HI-09-107 3mm
HI-09-108 4mm
HI-09-109 6mm
HI-09-110 7mm
HI-09-111 8mm

Partsch Gouge
11.5cm 4 1/2"
HI-09-112 2mm
HI-09-113 3mm
HI-09-114 4mm
HI-09-115 6mm
HI-09-116 7mm
HI-09-117 8mm

Partsch Gouge
13.5cm 5 1/4"
HI-09-118 2mm
HI-09-119 3mm
HI-09-120 4mm
HI-09-121 6mm
HI-09-122 7mm
HI-09-123 8mm

Partsch Gouge
17.5cm 6 3/4"
HI-09-124 2mm
HI-09-125 3mm
HI-09-126 4mm
HI-09-127 6mm
HI-09-128 7mm
HI-09-129 8mm

BONE CHISELS & GOUGES



Knochenmeibel
Ciseaux-burins, gouges

Cineles, gubias
Scalpelli, sgorbi



- | | |
|-----------|-------|
| Straight | |
| HI-09-130 | 09 mm |
| HI-09-131 | 14 mm |
| HI-09-132 | 19 mm |
| HI-09-133 | 25 mm |
| Curved | |
| HI-09-134 | 09 mm |
| HI-09-135 | 14 mm |
| HI-09-136 | 19 mm |
| HI-09-137 | 25 mm |

Smith Peterson Gouge
20 cm, 8"



- | | |
|-----------|-------|
| Straight | |
| HI-09-138 | 06 mm |
| HI-09-139 | 09 mm |
| HI-09-140 | 13 mm |
| HI-09-141 | 16 mm |
| HI-09-142 | 19 mm |
| HI-09-143 | 25 mm |
| HI-09-144 | 32 mm |
| Curved | |
| HI-09-145 | 06 mm |
| HI-09-146 | 09 mm |
| HI-09-147 | 13 mm |
| HI-09-148 | 16 mm |
| HI-09-149 | 19 mm |
| HI-09-150 | 25 mm |
| HI-09-151 | 32 mm |

Smith Peterson Osteotome
20 cm, 8"



- | | |
|-----------|-------|
| Straight | |
| HI-09-152 | 10 mm |
| HI-09-153 | 15 mm |
| HI-09-154 | 20 mm |
| HI-09-155 | 25 mm |
| Curved | |
| HI-09-156 | 10 mm |
| HI-09-157 | 15 mm |
| HI-09-158 | 20 mm |
| HI-09-159 | 25 mm |

Stille Gouge
20 cm, 8"



Stille
20 cm, 8"

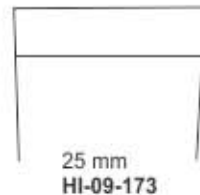
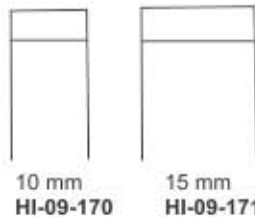

Stille Chisel
20 cm, 8"

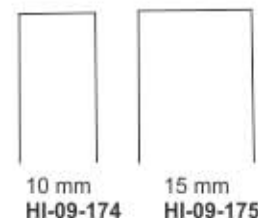

Stille Osteotome
20 cm, 8"

- | | |
|------------------|-------|
| Chisels | |
| HI-09-160 | 10 mm |
| HI-09-161 | 12 mm |
| HI-09-162 | 15 mm |
| HI-09-163 | 20 mm |
| HI-09-164 | 25 mm |
| Osteotome | |
| HI-09-165 | 10 mm |
| HI-09-166 | 12 mm |
| HI-09-167 | 15 mm |
| HI-09-168 | 20 mm |
| HI-09-169 | 25 mm |



Lexer Osteotome

22 cm, 8 3/4"

- HI-09-178 7 mm
- HI-09-179 10 mm
- HI-09-180 12 mm
- HI-09-181 15 mm
- HI-09-182 20 mm
- HI-09-183 25 mm
- HI-09-184 30 mm

Lexer Modif. Osteotome

29 cm, 11 1/2"

- HI-09-185 7 mm
- HI-09-186 10 mm
- HI-09-187 12 mm
- HI-09-188 15 mm
- HI-09-189 20 mm
- HI-09-190 25 mm
- HI-09-191 30 mm



Lexer Modif. Chisel

29 cm, 11 1/2"

- HI-09-192 7 mm
- HI-09-193 10 mm
- HI-09-194 12 mm
- HI-09-195 15 mm
- HI-09-196 20 mm
- HI-09-197 25 mm
- HI-09-198 30 mm

Lexer Chisel

22 cm, 8 3/4"

- HI-09-199 7 mm
- HI-09-200 10 mm
- HI-09-201 12 mm
- HI-09-202 15 mm
- HI-09-203 20 mm
- HI-09-204 25 mm
- HI-09-205 30 mm



Lexer Gouge

25 mm, 10"

- HI-09-206 7 mm
 - HI-09-207 10 mm
 - HI-09-208 15 mm
- Straight



Lexer Gouge

25 mm, 10"

- HI-09-209 7 mm
 - HI-09-210 10 mm
 - HI-09-211 15 mm
- Curved



Lexer Osteotome Flat

22 cm, 8 3/4"

- HI-09-212 10 mm
- HI-09-213 15 mm
- HI-09-214 20 mm
- HI-09-215 25 mm



Lexer Gouge

Tuffnel Handle

22 cm, 8 3/4"

- HI-09-216 10 mm
- HI-09-217 15 mm
- HI-09-218 20 mm
- HI-09-219 25 mm

BONE CHISELS & GOUGES



Knochenmeißel
Ciseaux-burins, gouges

Cineles, gubias
Scalpelli, sgorbi



Mini Lexer Osteotome
HI-09-220
18 cm, 7"



Mini Lexer Chisel
HI-09-221
18 cm, 7"
Hollow



Capener Osteotome
With Tuffnel Handle
25cm 10"
HI-09-222 10mm
HI-09-223 12mm
HI-09-224 15mm
HI-09-225 20mm
HI-09-226 25mm
HI-09-227 30mm
Straight



Capener Osteotome
With Tuffnel Handle
25cm 10"
HI-09-228 10mm
HI-09-229 12mm
HI-09-230 15mm
HI-09-231 20mm
HI-09-232 25mm
HI-09-233 30mm
Curved



Capener Chisels
With Tuffnel Handle
25cm 10"
HI-09-234 6mm
HI-09-235 8mm
HI-09-236 10mm
HI-09-237 12mm
HI-09-238 15mm
HI-09-239 20mm
HI-09-240 25mm
HI-09-241 30mm
Straight



Capener Osteotome
With Tuffnel Handle
25cm 10"
HI-09-242 6mm
HI-09-243 8mm
HI-09-244 10mm
HI-09-245 12mm
HI-09-246 15mm
HI-09-247 20mm
HI-09-248 25mm
HI-09-249 30mm
Curved



Lambotte Osteotome

25cm 9 3/4"

- HI-09-250 6mm
- HI-09-251 8mm
- HI-09-252 10mm
- HI-09-253 13mm
- HI-09-254 15mm
- HI-09-255 20mm
- HI-09-256 25mm
- HI-09-257 30mm
- HI-09-258 38mm
- HI-09-259 44mm
- HI-09-260 50mm

Straight



Lambotte Osteotome

25cm 9 3/4"

- HI-09-261 6mm
- HI-09-262 8mm
- HI-09-263 10mm
- HI-09-264 13mm
- HI-09-265 15mm
- HI-09-266 20mm
- HI-09-267 25mm
- HI-09-268 30mm
- HI-09-269 38mm
- HI-09-270 44mm
- HI-09-271 50mm

Curved



Mini-Lambotte Osteotome

12.5cm 5"

- HI-09-272 3mm
- HI-09-273 4mm
- HI-09-274 6mm
- HI-09-275 8mm
- HI-09-276 10mm
- HI-09-277 12mm
- HI-09-278 15mm

Straight



Mini-Lambotte Osteotome

17cm 6 3/4"

- HI-09-279 3mm
- HI-09-280 4mm
- HI-09-281 6mm
- HI-09-282 8mm
- HI-09-283 10mm
- HI-09-284 12mm
- HI-09-285 15mm

Straight



Lambotte Osteotome

12.5cm, 5" Straight

- HI-09-286 2mm tip width
- HI-09-287 4mm tip width
- HI-09-288 6mm tip width
- HI-09-289 8mm tip width
- HI-09-290 10mm tip width
- HI-09-291 12mm tip width
- HI-09-292 15mm tip width



Hex Handle Osteotome

15cm, 6" Straight

- HI-09-293 2mm tip width
- HI-09-294 3mm tip width
- HI-09-295 4mm tip width
- HI-09-296 5mm tip width
- HI-09-297 6mm tip width
- HI-09-298 7mm tip width
- HI-09-299 9mm tip width
- HI-09-300 10mm tip width



Cottle Osteotome

18.5cm, 7 1/4" Straight

- HI-09-301 4mm tip width
- HI-09-302 6mm tip width
- HI-09-303 9mm tip width
- HI-09-304 12mm tip width



Anderson-Nievert Osteotome

20.4cm 8"

- HI-09-305 Curved right
- HI-09-306 Curved left
- HI-09-307 Straight

BONE CHISELS & GOUGES



Knochenmeißel
Ciseaux-burins, gouges

Cineles, gubias
Scalpelli, sgorbi



Stille
20cm 8"



Stille Chisel
HI-09-308 10mm
HI-09-309 15mm
HI-09-310 20mm
HI-09-311 25mm
Straight



Stille Osteotome
HI-09-312 10mm
HI-09-313 15mm
HI-09-314 20mm
HI-09-315 25mm
Straight



Stille Osteotome
HI-09-316 10mm
HI-09-317 15mm
HI-09-318 20mm
HI-09-319 25mm
Curved



Stille Gouge
HI-09-320 10mm
HI-09-321 15mm
HI-09-322 20mm
HI-09-323 25mm
Straight



Stille Gouge
HI-09-324 10mm
HI-09-325 15mm
HI-09-326 20mm
HI-09-327 25mm
Curved



Smith-Petersen
20cm 8"



Smith-Petersen osteotome
HI-09-328 6mm
HI-09-329 9mm
HI-09-330 13mm
HI-09-331 16mm
HI-09-332 19mm
HI-09-333 25mm
HI-09-334 32mm
Straight



Smith-Petersen Osteotome
HI-09-335 6mm
HI-09-336 9mm
HI-09-337 13mm
HI-09-338 16mm
HI-09-339 19mm
HI-09-340 25mm
HI-09-341 32mm
Curved



Smith-Petersen Gouge
HI-09-342 9mm
HI-09-343 16mm
HI-09-344 19mm
HI-09-345 25mm
Straight



Smith-Petersen Gouge
HI-09-346 9mm
HI-09-347 16mm
HI-09-348 19mm
HI-09-349 25mm
Curved

BONE CHISELS & GOUGES

Knochenmeißel

Ciseaux-burins, gouges

Cineles, gubias

Scalpelli, sgorbi



Freer Gouge
HI-09-350 15cm 6"
06mm



Freer Chisel
HI-09-351
16cm 6 1/4"
04mm



Shoulder Penetrating Gouge
HI-09-352
21.6cm 8 1/2"
Straight, 3mm distal tip



Ballenger Chisel
HI-09-353 04mm
HI-09-354 06mm
HI-09-355 08mm
16cm 6 1/4"



Mannerfelt Modif.

Osteotomes

HI-09-356 04mm
HI-09-357 06mm
HI-09-358 08mm
15.5cm 6"

Gouge

HI-09-359 03mm
15.5cm 6"



Kilian, Septum Gouge
HI-09-360 16cm 6 1/4"
05mm



Kilian-Claus Septum Gouge
HI-09-361 16cm 6 1/4"
05mm



Cottle Osteotome
HI-09-362 07mm
HI-09-363 12mm
15cm 6"



Cottle Osteotome
HI-09-364 19cm 7 1/2"
04mm



Cottle Osteotome with depth markings
HI-09-365 18cm 7"
06mm

BONE CHISELS & GOUGES



Knochenmeißel
Ciseaux-burins, gouges

Cineles, gubias
Scalpelli, sgorbi



Fomon Chisel
17cm 6 3/4"

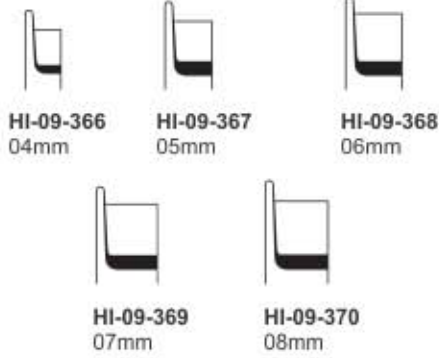

Cinelli Chisel
18cm 7"

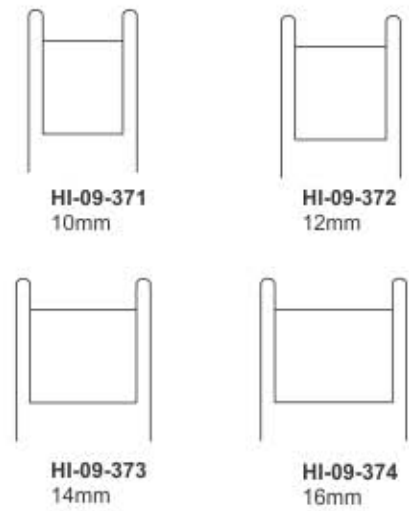

Cottle Osteotome
18cm 7"

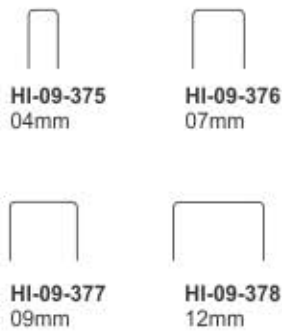

Cottle Chisel
18cm 7"

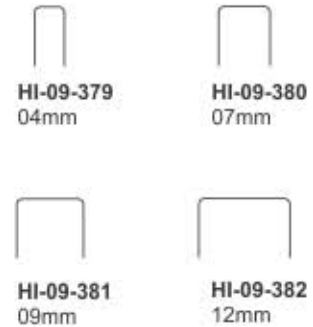

Meißel zur Nasenplastik

Osteotomes, ciseaux-burins pour rhinoplastique

Cinceles para rinoplastica

Scalpelli per plastica nasale



Sheehan osteotome
16cm 6 1/4"



HI-09-383
2mm



HI-09-384
4mm



HI-09-385
6mm



HI-09-386
8mm



HI-09-387
10mm



HI-09-388
12mm



HI-09-389
15mm



HI-09-390
18mm



Silver Rhinoplastic Chisel

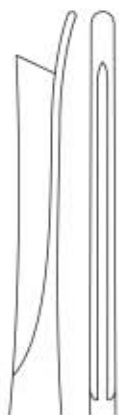

HI-09-391
18cm 7"
Straight



HI-09-392
18cm 7"
right

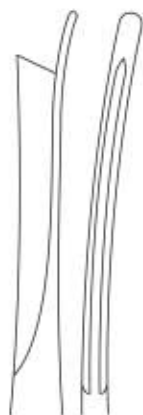

HI-09-393
18cm 7"
Left



Neivert-Anderson osteotome



HI-09-394
20cm 8"
Straight

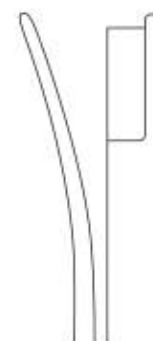

HI-09-395
20cm 8"
right

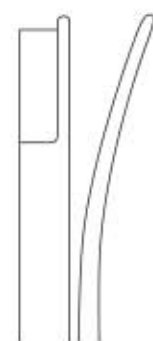

HI-09-396
20cm 8"
Left

TAMPERS



Stobel | Punzones
Pilons | Pestoni



Obwegeser Osteotome
HI-09-397 23.5cm 9 1/4"
11mm



Obwegeser Blade osteotome
HI-09-398 7mm
21.5cm 8 1/2"



Obwegeser Blade osteotome
HI-09-399 10mm
21.5cm 8 1/2"



HI-09-400
15.5cm 6"
Head diameter
2mm



HI-09-401
15.5cm 6"
Head diameter
3mm



HI-09-402
15.5cm 6"
Head diameter
4mm



HI-09-403
15.5cm 6"
Head diameter
5mm



HI-09-404
15.5cm 6"
Head diameter
6mm



HI-09-405
15.5cm 6"
Head diameter
8mm



HI-09-406
15.5cm 6"
Head diameter
10mm

Bone Tamper



HI-09-407
2.5mm x 2.5mm

HI-09-408
3.5mm x 3.5mm

Passow Bone Tamper
12cm 4 3/4"



HI-09-409
3mm

HI-09-410
5mm

HI-09-411
8mm

Caspar Bone Tamper
20cm 8"



HI-09-412
12mm

HI-09-413
14mm

HI-09-414
16mm

Caspar Bone Tamper
20cm 8"



Tip Size Available
2 mm
3 mm
4 mm
5 mm
6 mm
8 mm
10 mm

Bone Tamps
HI-09-415
15.4 cm, 6"











BONE CURETTES

Scharfe Löffel
Curettes tranchantes

cucharillas cortantes
Cucchiai taglienti









**Volkman
Bone Curette**

- | | | |
|--|---|--|
| 
HI-09-416
17 cm, 7"
0000 | 
HI-09-417
17 cm, 7"
000 | 
HI-09-418
17 cm, 7"
00 |
| 
HI-09-419
17 cm, 7"
0 | 
HI-09-420
17 cm, 7"
1 | 
HI-09-421
17 cm, 7"
2 |
| 
HI-09-422
17 cm, 7"
3 | 
HI-09-423
17 cm, 7"
4 | 
HI-09-424
17 cm, 7"
5 |
| | | 
HI-09-425
17 cm, 7"
6 |











**Schede
Bone Curette**
17 cm, 6 3/4"

- | | | |
|---|--|---|
| 
HI-09-426
17 cm, 7"
000 | 
HI-09-427
17 cm, 7"
00 | 
HI-09-428
17 cm, 7"
0 |
| 
HI-09-429
17 cm, 7"
1 | 
HI-09-430
17 cm, 7"
2 | 
HI-09-431
17 cm, 7"
3 |
| | | 
HI-09-432
17 cm, 7"
4 |













**Bruns
Bone Curette**

- | | |
|---|--|
| 
HI-09-433
17 cm, 7"
000 | 
HI-09-434
17 cm, 7"
00 |
| 
HI-09-435
17 cm, 7"
0 | 
HI-09-436
17 cm, 7"
1 |
| 
HI-09-437
17 cm, 7"
2 | 
HI-09-438
17 cm, 7"
3 |
| 
HI-09-439
17 cm, 7"
4 | 
HI-09-440
17 cm, 7"
5 |
| | 
HI-09-441
17 cm, 7"
6 |



**Spratt Bone Curette
/ Hollow Handle**

- | | | |
|--|--|---|
| 
HI-09-442
16.5 cm, 6 1/2"
00000 | 
HI-09-443
16.5 cm, 6 1/2"
0000 | 
HI-09-444
16.5 cm, 6 1/2"
000 |
| 
HI-09-445
16.5 cm, 6 1/2"
00 | 
HI-09-446
16.5 cm, 6 1/2"
0 | 
HI-09-447
16.5 cm, 6 1/2"
1 |
| 
HI-09-448
16.5 cm, 6 1/2"
2 | 
HI-09-449
16.5 cm, 6 1/2"
3 | 
HI-09-450
16.5 cm, 6 1/2"
4 |
| | | 
HI-09-451
16.5 cm, 6 1/2"
5 |

BONE CURETTES



Scharfe Löffel | cucharillas cortantes
Curettes tranchantes | Cucchiali taglienti



**Schroeder
Bone Curette**
Sharp / rigid



HI-09-452
30.0 cm, 12"
1



HI-09-453
30.0 cm, 12"
2



HI-09-454
30.0 cm, 12"
3



HI-09-455
30.0 cm, 12"
4



HI-09-456
30.0 cm, 12"
5



HI-09-457
30.0 cm, 12"
6



**Simon
Bone Curette**
Sharp / rigid



HI-09-458
24.0 cm, 9 1/2"
0000



HI-09-459
24.0 cm, 9 1/2"
000



HI-09-460
24.0 cm, 9 1/2"
00



HI-09-461
24.0 cm, 9 1/2"
0



HI-09-462
25.0 cm, 9 3/4"
1



HI-09-463
25.0 cm, 9 3/4"
2



HI-09-464
25.0 cm, 9 3/4"
3



HI-09-465
25.0 cm, 9 3/4"
4



HI-09-466
25.0 cm, 9 3/4"
5



HI-09-467
25.0 cm, 9 3/4"
6

BONE CURETTES

Scharfe Löffel
Curettes tranchantes

cucharillas cortantes
Cucchiai taglienti



**Volkmann
Curette**
Oval / Oval

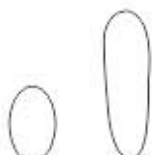

HI-09-468
13 cm, 5 1/4"



HI-09-469
14 cm, 5 1/4"



HI-09-470
17 cm, 6 3/4"



**Volkmann
Curette**
Round / Oval



HI-09-471
13 cm, 5 1/4"



HI-09-472
16 cm, 6 1/4"



HI-09-473
20 cm, 8"



**Curette
HI-09-474**
21cm 8 1/4"
round / oval



**Martini
Curette**
13.5 cm, 5 1/4"

- HI-09-475
00
- HI-09-476
0
- HI-09-477
0
- HI-09-478
1
- HI-09-479
1
- HI-09-480
2



**Martini
Curette**
15.5 cm, 6"

- HI-09-481
00
- HI-09-482
0
- HI-09-483
1



**Williger
Curette**
13.5 cm, 5 1/4"

- HI-09-484
00
- HI-09-485
0
- HI-09-486
0
- HI-09-487
1
- HI-09-488
1
- HI-09-489
2



**Williger
Curette**
15.5 cm, 6"

- HI-09-490
00
- HI-09-491
0
- HI-09-492
1

BONE CURETTES



Scharfe Löffel

cucharillas cortantes

Curettes tranchantes

Cucchiai taglienti



Jansen Curette
HI-09-493
16 cm, 6 1/4"







Jansen Curette
HI-09-494
15 cm, 6"



Williger Curette
HI-09-495
13.25 cm, 5 1/2"
Double Ended
00/0



 
HI-09-496
 13 cm, 5"
 Double Ended
 6.2 mm & 6.7 mm
 
HI-09-497
 16 cm, 6 1/2"
 Double Ended
 7 mm & 9 mm
  1/4
HI-09-498
 20 cm, 8"
 Double Ended
 9.1 mm & 11.1 mm

Curette



Lucas Curette
double-ended
18 cm, 7"



Fig. 1 R/L
HI-09-499



Fig. 2 R/L
HI-09-500



Fig. 3 R/L
HI-09-501

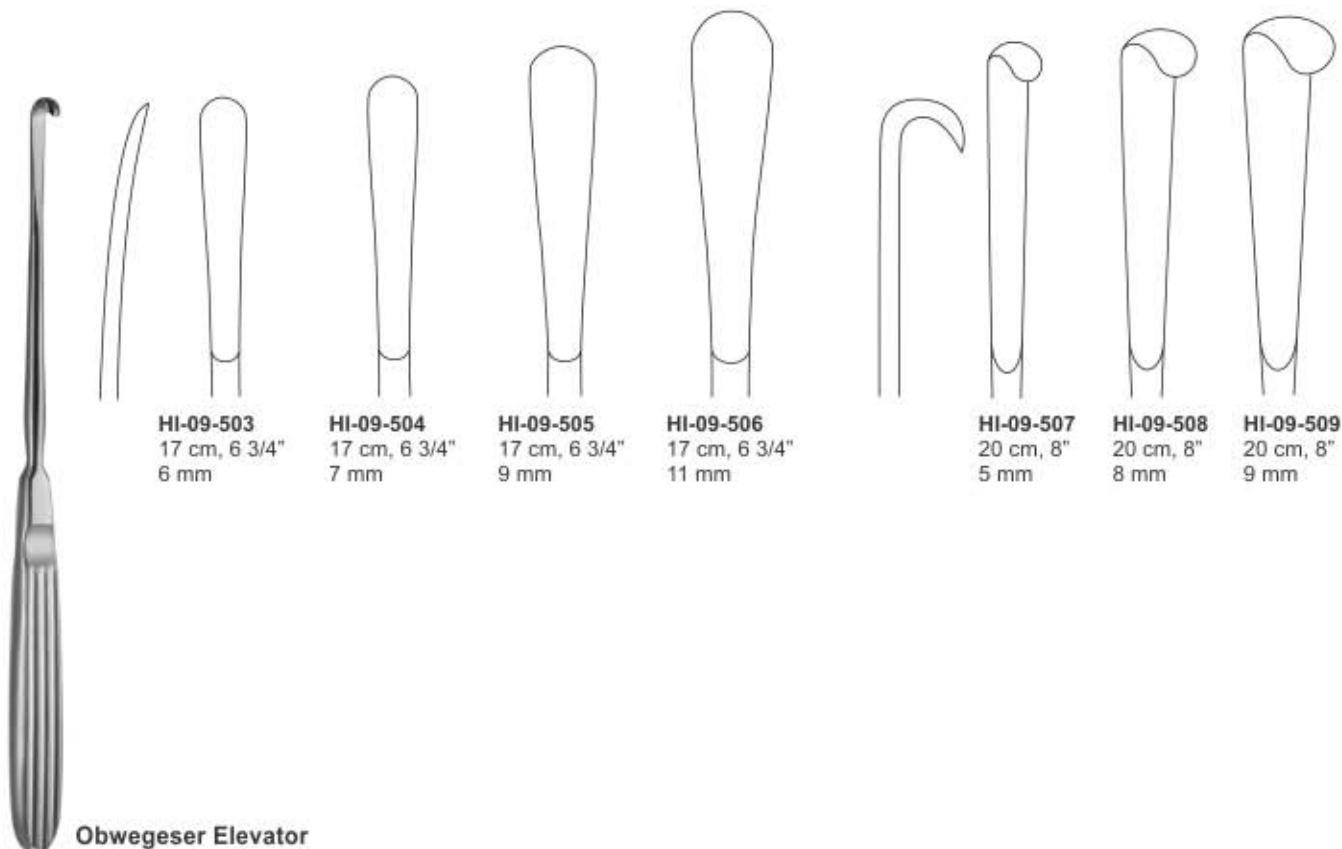

Fig. 4 R/L
HI-09-502

PERIOSTEAL ELEVATORS

Raspatorien
Periostótomos

Rugines-raspatoires
Periostotomi



Obwegeser Elevator

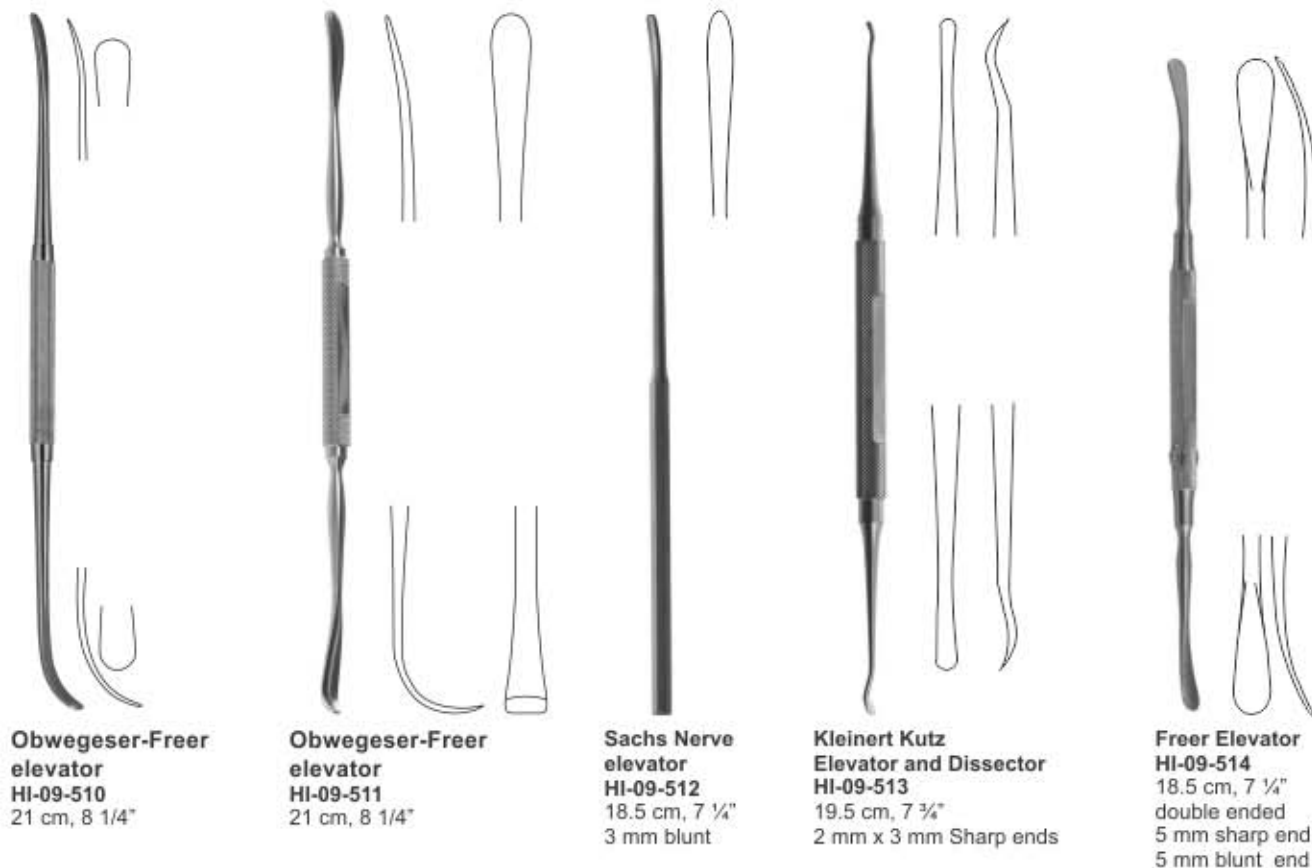

PERIOSTEAL ELEVATORS



Raspatorien
Periostótomos

Rugines-raspatoires
Periostotomi



Obwegeser Needle
HI-09-515
17.5 cm, 7"



Obwegeser Needle
HI-09-516
23 cm, 9"



Obwegeser Needle
HI-09-517
18 cm, 7"



Obwegeser Needle
HI-09-518
14 cm, 5 1/2"



HI-09-519
Right Crved
For Adults



HI-09-520
Right Crved
For Children

Doyen Rib Raspatory
17 cm, 7"



HI-09-521
Left Crved
For Adults



HI-09-522
Left Crved
For Children

Doyen Rib Raspatory
17 cm, 7"



Sedillot Elevator
HI-09-523 18.5cm, 7 1/4"
HI-09-524 21.0cm, 8 1/4"

PERIOSTEAL ELEVATORS

Raspatorien
Periostótomos

Rugines-raspatoires
Periostotomi



Crego Periosteal Elevator
HI-09-525
15.5cm, 6"

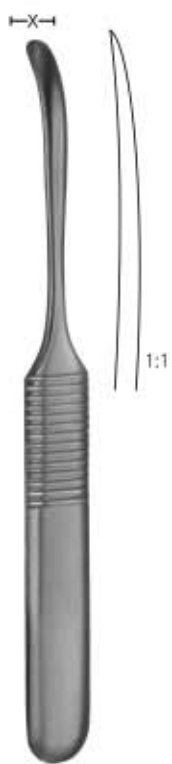

Williger Elevator
HI-09-526 13cm, 5"
5mm



Williger Elevator
HI-09-527 4mm
HI-09-528 6mm
16cm, 6 1/4"



Williger Elevator
HI-09-529
16cm, 6 1/4"
5mm



Williger Elevator
HI-09-530
16cm, 6 1/4"
6.5mm



Farabeuf-Collin Elevator
HI-09-531
16cm, 6 1/4"
11mm
Straight

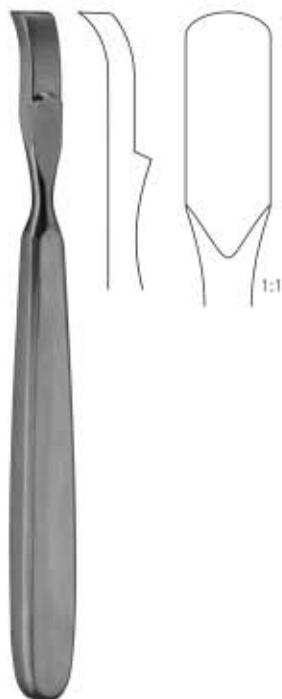

Farabeuf-Collin Elevator
HI-09-532
16cm, 6 1/4"
11mm
Curved



Farabeuf Elevator
HI-09-533
15cm, 6"
Straight



Farabeuf Elevator
HI-09-534
15cm, 6"
Curved



Lambotte Elevator
HI-09-535 5mm
HI-09-536 10mm
HI-09-537 15mm
HI-09-538 20mm
HI-09-539 25mm
21cm, 8 1/4" Straight

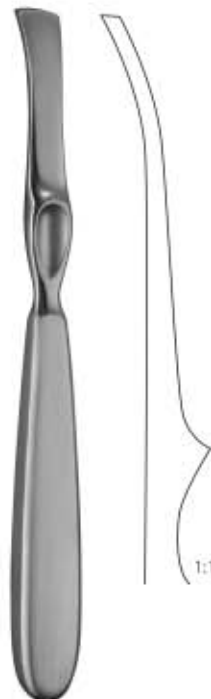

Lambotte Elevator
HI-09-540 5mm
HI-09-541 10mm
HI-09-542 15mm
HI-09-543 20mm
HI-09-544 25mm
21cm, 8 1/4" Curved

BONE LEVERS

Knochenhebel
Leviers a os

Elevadores para huesos
Elevatori per ossa



**Hohmann
Bone Elevator**
HI-09-545 43mm
24.5 cm, 9 1/2"

**Hohmann
Bone Elevator**
HI-09-546 22mm
26cm, 10 1/4"

**Hohmann
Bone Elevator**
HI-09-547 33mm
28cm, 11"

**Hohmann
Bone Elevator**
HI-09-548 24mm
26.5cm, 10 1/2"

**Hohmann
Bone Elevator**
HI-09-549 22mm
26cm, 10 1/4"

BONE LEVERS

Knochenhebel
Leviers a os

Elevadores para huesos
Elevatori per ossa



Capsule Retractor
HI-09-550 25.5cm 10"
3 sharp-pronged,
22mm width blade



**Bristow-Bankart
Humeral Retractor**
HI-09-551 19.0cm 7 1/2"
Double-pronged,
25mm width x 102mm
depth blade



**Bristow-Bankart Soft
Tissue Retractor**
HI-09-552 20.0cm 7 7/8"
3-pronged
21mm width blade,



Humeral Head Retractor
HI-09-553 22.0cm 8 3/4"
18mm width blade



Hohmann Bone Elevator
HI-09-554 22cm, 8 3/4"
08mm width blade
HI-09-555 23.0cm 9"
10mm width blade



Hohmann Bone Elevator
HI-09-556 24cm, 9 1/2"
18mm



Hohmann Bone Elevator
HI-09-557 24cm, 9 1/2" 70mm
HI-09-558 28.5cm 11 1/4" 35mm width blade
HI-09-559 33.0cm 13" 40mm width blade



**Hohmann Long Shank
Retractor**
HI-09-560 23.0cm 9"
43mm width blade

BONE LEVERS



Knochenhebel
Leviers a os

Elevadores para huesos
Elevatori per ossa



Mini-Hohmann Bone Elevator



HI-09-561
16cm, 6 1/4"
6mm width blade

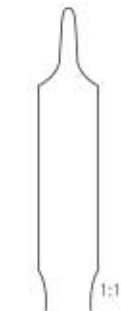

HI-09-562
16cm, 6 1/4"
8mm width blade



Hohmann Bone Lever HI-09-563
15 cm, 6"



Hohmann Bone Lever HI-09-564
15.4 cm, 6"
Short tip



Hohmann Retractor HI-09-565
15.0cm 6"
15mm width blade



Hayes Hand Retractor HI-09-566 16.0cm 6 1/4"
3mm width blade



Hayes Hand Retractor HI-09-567 15.0cm 6"
6mm width blade



Bone Lever

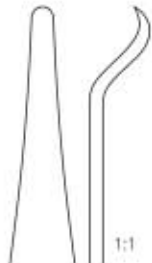

HI-09-568 14cm, 5 1/2"
2.8mm

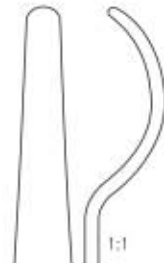

HI-09-569 14cm, 5 1/2"
4.5mm

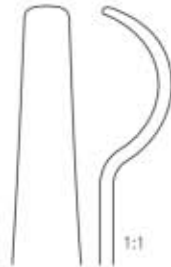

HI-09-570 14cm, 5 1/2"
6mm



Bristow Bone Lever HI-09-571 23cm, 9"



Lane Bone Lever HI-09-572
21cm, 8 1/4"

BONE LEVERS

Knochenhebel
Leviers a os

Elevadores para huesos
Elevatori per ossa

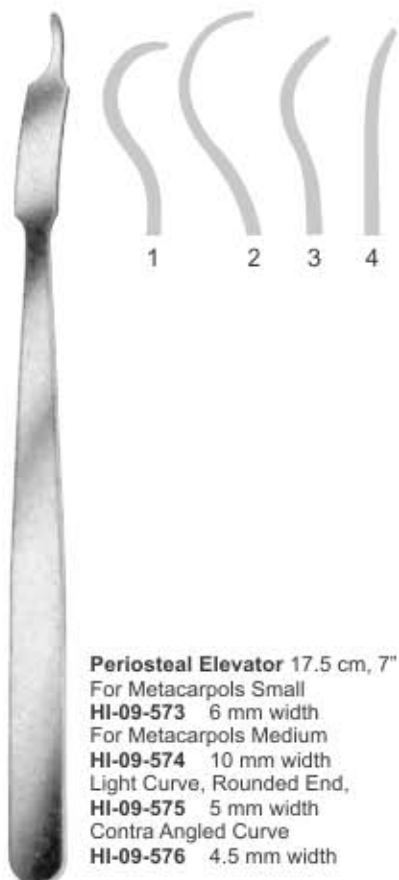

Periosteal Elevator 17.5 cm, 7"

For Metacarpals Small
HI-09-573 6 mm width
For Metacarpals Medium
HI-09-574 10 mm width
Light Curve, Rounded End,
HI-09-575 5 mm width
Contra Angled Curve
HI-09-576 4.5 mm width

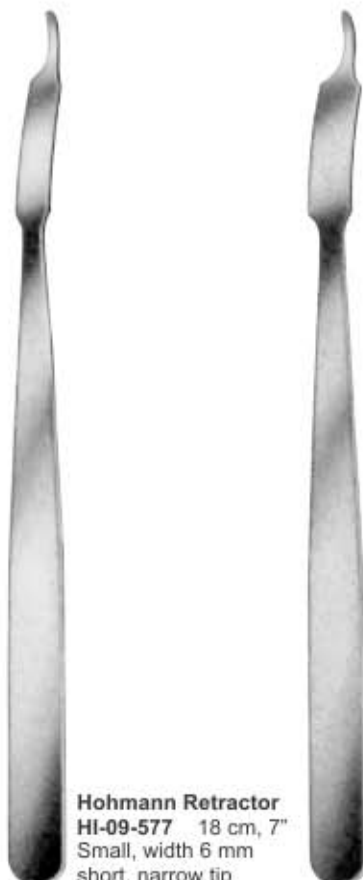

Hohmann Retractor
HI-09-577 18 cm, 7"
Small, width 6 mm
short, narrow tip

Hohmann Retractor
HI-09-578 18 cm, 7"
Small, width 8 mm
short, narrow tip

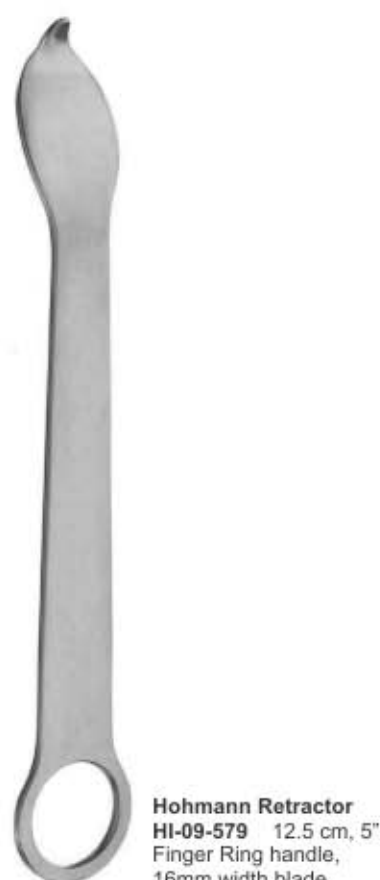

Hohmann Retractor
HI-09-579 12.5 cm, 5"
Finger Ring handle,
16mm width blade



Hohmann-Williger
Retractor
HI-09-580 16 cm, 6 1/4"



Blount Retractor
HI-09-581
17.5cm, 7"



Taylor Retractor
16.5cm, 6 1/2"
HI-09-582 a=75mm - b=30mm
HI-09-583 a=100mm - b=30mm

BONE LEVERS



Knochenhebel
Leviers a os

Elevadores para huesos
Elevatori per ossa



Cushing Vein Retractor
HI-09-584 22.5 cm, 9"
with fenestrated handle
Blade 12 mm width x 10 mm



Cushing Decompression Retractor
HI-09-585 21.5 cm, 8 1/2"
with fenestrated blade and handle
Blade 13 mm width x 22 mm



Scoville Nerve Retractor
HI-09-586
24 cm, 9 1/2", 7 mm
straight



Scoville Nerve Retractor
HI-09-587
24 cm, 9 1/2", 7 mm
angled



Taylor Retractor
17 cm, 6 3/4"
HI-09-588 30 x 75 mm
HI-09-589 30 x 100 mm



Hibbs Retractor
HI-09-590 25 x 75 mm, 23 cm, 9"
HI-09-591 25 x 80 mm, 24 cm, 9 1/2"



Meyerding Retractor
HI-09-592 16 X 50 mm, 20 cm, 8"
HI-09-593 25 X 75 mm, 23 cm, 9"
HI-09-594 50 X 90 mm, 24 cm, 9 1/2"

MENISCOTOMY KNIVES

Meniskotome

Bisturios para meniscos

Bistouries a menisques

Bisturi per menisco



Bircher Meniscotomy Knife
HI-09-595
 19cm 7 1/2"



Matson Meniscotomy Knife
HI-09-596
 22 cm, 9"



Downing Cartilage Knife
HI-09-597 25.5cm 10"
 Curved tip, Straight shaft

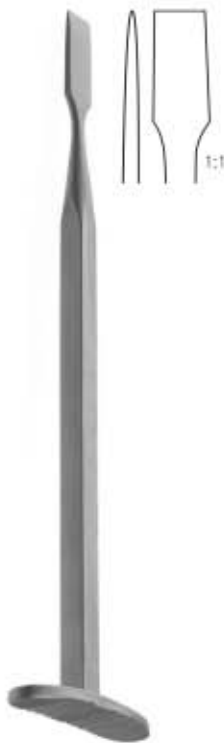

Smillie Meniscotomy Knife
HI-09-598
 16cm 6 1/4" Straight shaft,
 Blade tip width is 7.8mm
 Straight tip



Smillie Meniscotomy Knife
HI-09-599
 16cm 6 1/4" curved shaft,
 Blade tip width is 7.8mm
 Curved left tip



Smillie Meniscotomy Knife
HI-09-600
 16cm 6 1/4" Curved shaft,
 Blade tip width is 7.8mm
 Curved left tip

Orthopädie
Ortopedia

Orthopédie
Ortopedia

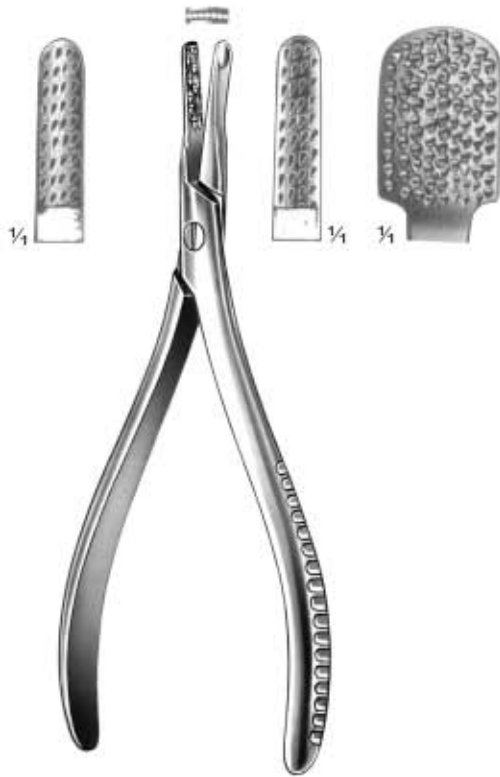

Nail Extracting Forceps
HI-09-601
14 cm, 5 1/2"



Nail Extracting Forceps
HI-09-602
14.5 cm, 5 3/4"

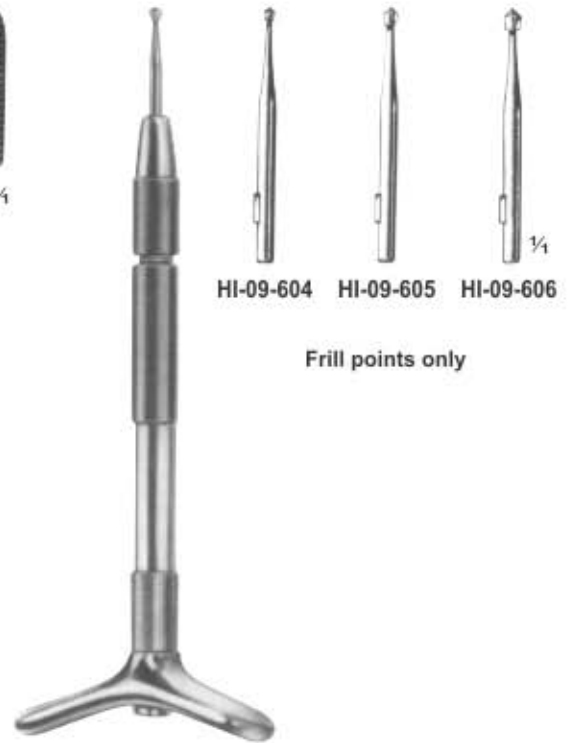

Finger Nail Drill
with 3 drill points
HI-09-603

Frill points only



Nail Splitting Forceps
HI-09-607
13.5 cm, 5 1/4"



Ring Cutter
HI-09-608
17 cm, 6 3/4"



Ring Cutter
HI-09-610
17 cm, 6 3/4"



Tendon Tunelling Forceps
HI-09-612
 13cm 5"



Tendon Tunelling Forceps

HI-09-613
 15cm 6"



Tendon Tunelling Forceps

HI-09-614
 15.25 cm, 6"
 6 mm



Brand Tendon Forceps
HI-09-615 15 cm, 6"
HI-09-616 19 cm, 7 1/2"
HI-09-617 24 cm, 9 1/2"



Carroll Tendon Forceps
HI-09-618 13 cm, 5"
 Curved Shaft
 2 mm x 6 mm



Lead Hand
HI-09-619
 Adult Size

TENDON STRIPPERS



Sehnenstripper

Instruments a ecorcher les tendons

enucleadores de tendones

Scollatendini



Needle Nose Pliers

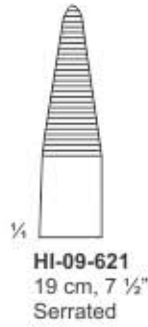

Needle Nose Pliers



Flat Nose Plier
HI-09-622
18 cm, 7"



Flat Nose Pliers
HI-09-623
13.5cm 5 3/8"
Broad, 4mm tip,



Flat Nose Pliers
HI-09-624
16.5cm 6 1/2"
Combination plier and
cutter



Needle Nose Pliers
HI-09-625
13.5cm 5 3/8"



Flat Nose Pliers
HI-09-626
15cm 6" Delicate, 1.5mm tip



K-Wire Extraction Pliers
W/Screw Lock
HI-09-627
13cm 5" 3mm tip



Flat Nose K-Wire Pliers
HI-09-628 14.0cm 5 1/2"
HI-09-629 17.0cm 6 3/4"



Nose Pliers
HI-09-630
17cm 6 3/4"



Pin Puller W/ Groove TC
HI-09-631
14.0cm 5 1/2"



Utility Technical Forceps Pliers
HI-09-632 19cm 7 1/2"
adjustable



Vital Heavy Duty Pliers TC
HI-09-633 22cm 8 3/4"
Grip Forceps, Combined with cutter



Vital Wire Extraction Pliers T.C
HI-09-634 5mm
HI-09-635 7mm
18cm 7"

TECHNICAL FORCEPS

Technische Zangen | Pinzas técnicas
Pincers techniques | Pinze tecniche



Wire Bending Forceps
HI-09-636 18.5.0cm 7 1/4"



Flat Nose Plier
HI-09-637 18.5.0cm 7 1/4"
parallel grip, incorporated
cutter, for hard wires up to
1.6mm



Locking Plier
HI-09-643 22cm 8 3/4"
HI-09-644 25cm 9 3/4"
HI-09-645 30cm 12"
Locking plier, only
HI-09-646 30cm 12"
with holding pins
HI-09-647 46cm 18"
with extraction device



Locking Plier
HI-09-638 18cm 7"
HI-09-639 20cm 8"
HI-09-640 24cm 9 1/2"



Plate Bending Plier
HI-09-641 20cm 8"
for plates up to 2.7mm
HI-09-642 24cm 9 1/2"
for plates up to 4mm



Needle-Nose Locking Pliers
HI-09-648



Needle-Nose Locking Pliers
HI-09-649



Needle-Nose Locking Pliers
HI-09-650



Flat Nosed Plier
HI-09-651 18 cm, 7"
parallell, with lateral
wire cutter



Cast Spreader
Model Usa
HI-09-652 23 cm, 9"
3 Prong



Nail Extractor
HI-09-653 16 cm, 6 1/2"
with Longitudinal Grove
(for Intramudullary Gliding Nails)

BONE RONGEURS



Hohlmeißelzangen
Pinzas gubias

Pinces-gouges
Pinze-sgorbie

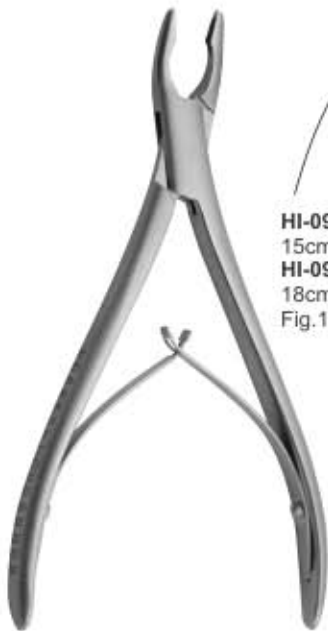

HI-09-654
15cm 6"
HI-09-655
18cm 7 1/8"
Fig.1



HI-09-656
15cm 6"
HI-09-657
18cm 7 1/8"
Fig.2



HI-09-658
17cm 6 3/4"
Fig. 1



HI-09-659
17cm 6 3/4"
Fig. 2



Friedmann Bone Rongeur
HI-09-660 14.5cm 5 3/4"
Single action, Curved,
4 x 11mm,



HI-09-661
15.5cm 6"
Fig. 1



HI-09-662
15.5cm 6"
Fig. 2



HI-09-663
15.5cm 6"
Fig. 3



HI-09-664
18cm 7"
Fig. 1



HI-09-665
18cm 7"
Fig. 2

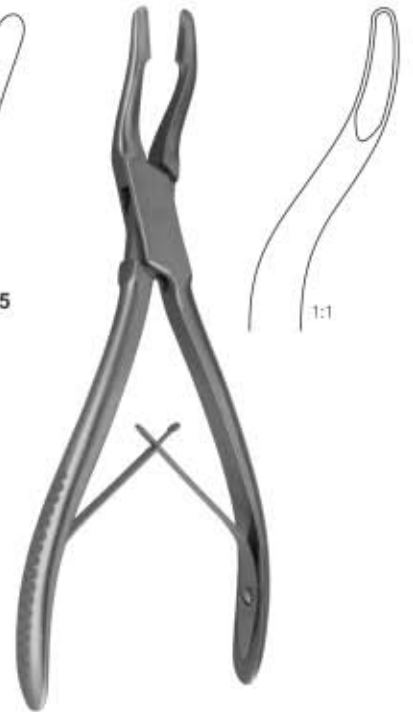

Jansen Bone Rongeur
HI-09-666 19cm 7 1/2"

Blumenthal Bone Rongeur

Jasen Bone Rongeur

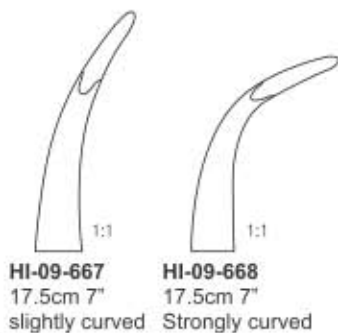

HI-09-667
17.5cm 7"
slightly curved

HI-09-668
17.5cm 7"
Strongly curved

Stellbrink Bone Rongeur

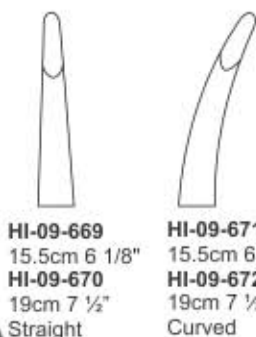

HI-09-669
15.5cm 6 1/8"
HI-09-670
19cm 7 1/2"
Straight

HI-09-671
15.5cm 6 1/8"
HI-09-672
19cm 7 1/2"
Curved

Lempert Bone Rongeur

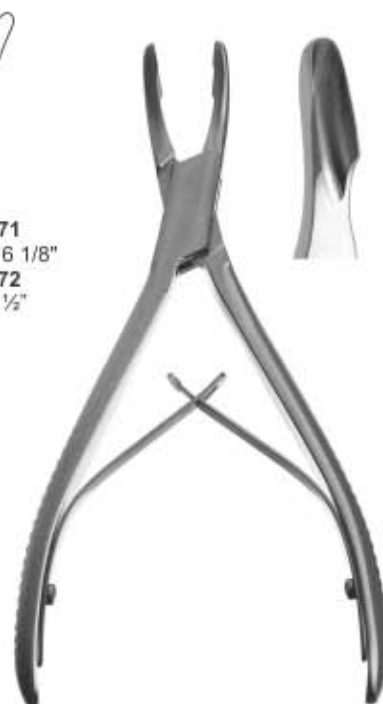

Rongeur #4
HI-09-673 14cm 5 1/2"
Rongeur #4A
HI-09-674 16.5cm 6 1/2"
Single action,
Curved, 4 x 9mm



Chichirelli (Blumenthal) Rongeur
HI-09-675
15cm 6"
Single action, Curved 45°,
4 x 13mm



Dean (Blumenthal) Rongeur
HI-09-676
15cm 6"
Single action,
Curved 90°, 4 x 11mm



Dean Rongeur
HI-09-677 14.5cm 5 3/4"
Single action
Curved, 3mm

BONE RONGEURS



Hohlmeißelzangen
Pinzas gubias

Pinces-gouges
Pinze-sgorbie



Hartmann Bone Rongeur
HI-09-678 18.5cm 7 1/4"
Single action
Curved, 4 x 14mm



Mead Bone Rongeur
HI-09-679 16.5cm 6 1/2"
Single action,
Curved, 5 x 13mm



Cleveland Bone Rongeur
HI-09-680
14cm 5 1/2"



Cleveland Bone Rongeur
HI-09-681
17cm 6 3/4"



HI-09-682
13.25 cm, 5 1/8"
Angled
17 mm x 3.5 mm

Universal Bone Rongeur



HI-09-683
18 cm, 7"
Single action
Curved,
3 x 16mm

Bane Bone Rongeur

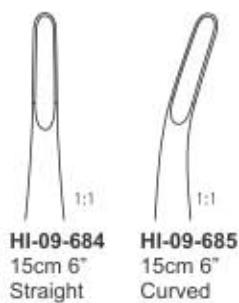

Bohler Bone Rongeur



Zaufal-Jansen Bone Rongeur
HI-09-686 18cm 7"
Double action
Curved, 5x15mm



Marquardt Bone Rongeur
HI-09-687
18cm 7"



Beyer Bone Rongeur
7" 18cm
HI-09-688 3 x 14mm
HI-09-689 4 x 15mm
Double action, Curved



Smith-Peterson Laminectomy Rongeur
HI-09-690 24cm 9 1/2"
Double action,
Straight 3 x 16mm



Smith-Peterson Laminectomy Rongeur
HI-09-691 24cm 9 1/2"
Double action
Curved 3 x 16mm

BONE RONGEURS



Hohlmeißelzangen
Pinzas gubias

Pinces-gouges
Pinze-sgorbie



Ruskin Rongeur
HI-09-692 18cm 7 1/8" 4 x 16mm
HI-09-693 18.5cm 7 1/4" 5 x 10mm
Double action, Curved on side



Ruskin Rongeur
HI-09-694 18.5cm 7 1/4"
Double action, 6 x 16mm,
Straight, Curved



Ruskin Rongeur
HI-09-695 15.5cm 6" Straight, 3.2mm
HI-09-696 15cm 6" Curved, 2 x 15mm
HI-09-697 15cm 6" Curved, 3 x 15mm
Double action,



Riskin Bone Rongeur



HI-09-698 15.5cm 6"
HI-09-699 18cm 7"
Double action
Straight, 2 x 14mm



HI-09-700 15.5cm 6"
HI-09-701 18cm 7"
Double action
Curved 2 x 14mm



Mayfield Bone Rongeur
HI-09-702 18cm 7"



Stille-Ruskin Bone Rongeur



HI-09-703
23cm 9"
Curved

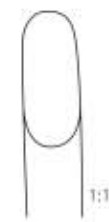

HI-09-704
23cm 9"
Straight

BONE RONGEURS

Hohlmeißelzangen | Pincés-gouges
Pinzas gubias | Pinze-sgorbie



Stille Bone Rongeur



HI-09-705
23cm 9"
4mm



HI-09-706
23cm 9"
6mm



HI-09-707
23cm 9"
8mm



Leksell Bone Rongeur

HI-09-708 24.5cm 9 5/8" 5 x 13mm
HI-09-709 24cm 9 1/2" 8 x 14.5mm
Double action, Curved 50°



Leksell Rongeur
HI-09-710 24cm 9 1/2"
6 x 15mm
HI-09-711 24cm 9 1/2"
7 x 13mm
Double action, Curved



Leksell Rongeur
HI-09-712 24cm 9 1/2"
3 x 18mm
Double action, Curved



Leksell Rongeur
HI-09-713 23cm 9"
4 x 13mm
Double action
Fully curved



Stille-Luer Rongeur Forceps



HI-09-714
23 cm, 9"
HI-09-715
27 cm, 10 1/2"
straight



HI-09-716
23 cm, 9"
HI-09-717
27 cm, 10 1/2"
curved



Echlin Duckbill Bone Rongeur
23cm 9"



HI-09-718
2 x 12mm
Double action
Curved on side



HI-09-719
3 x 12mm
Double action
Curved on side



HI-09-720
4.5 x 11mm
Double action
Curved on side

BONE RONGEURS



Hohlmeißelzangen
Pinzas gubias

Pinces-gouges
Pinze-sgorbie



Stille-Leur Rongeur
HI-09-721 21.5cm 8 1/2"
Curved, Straight
Double action, 10 x 18mm



Stille-Leur Rongeur
HI-09-722 26.5cm 10 1/2"
Straight, Curved
Double action, 10 x 18mm



Stille-Luer Echlin Duckbill Rongeur
23cm 9"
HI-09-723 6 x 13mm
HI-09-724 6 x 15mm
Double action Curved on side



Stille-Leur Rongeur
HI-09-725 21.5cm 8 1/2"
Double action
Curved 10 x 16mm



Rottgen-Ruskin Bone Rongeur
HI-09-726 23cm 9"

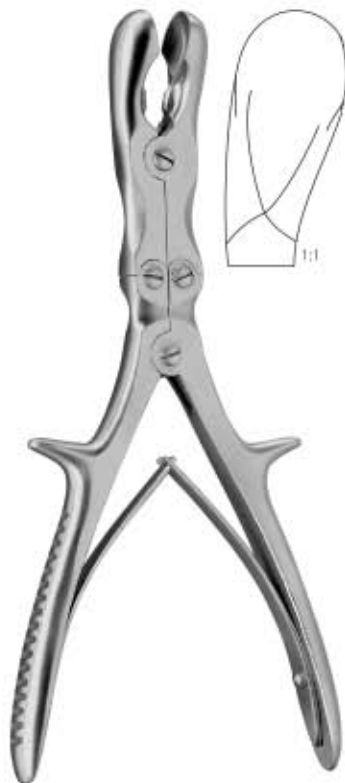

Semb Bone Rongeur
HI-09-727 24cm 9 1/2"



Frykholm Bone Rongeur
HI-09-728 24cm 9 1/2"



Sauerbruch Bone Rongeur
30 cm, 12"



Luer-Stille Bone Rongeur
27 cm, 10 3/4"

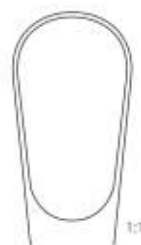

BONE RONGEURS



Hohlmeißelzangen
Pinzas gubias

Pinces-gouges
Pinze-sgorbie



HI-09-733
24 cm, 9 1/2"



HI-09-734
24 cm, 9 1/2"



HI-09-735
23 cm, 9"
Duckbill
17 mm x 6 mm



HI-09-736 25cm 9 3/4" 3 x 16mm
HI-09-737 23cm 9" 5 x 16mm
HI-09-738 25cm 9 3/4" 4.5 x 16mm
HI-09-739 25cm 9 3/4" 6 x 16mm
HI-09-740 25cm 9 3/4" 7 x 16mm
HI-09-741 25cm 9 3/4" 8 x 16mm
Double action, Curved 15°

Leksell-Stille Bone Rongeur

Stille Bone Rongeur

Leksell Bonerongeur



Hakansson Bone Rongeur
HI-09-742 20cm, 8"



HI-09-743
15.25 cm, 6"
2 x 13 mm

Kleinert-Kutz Bone Rongeur

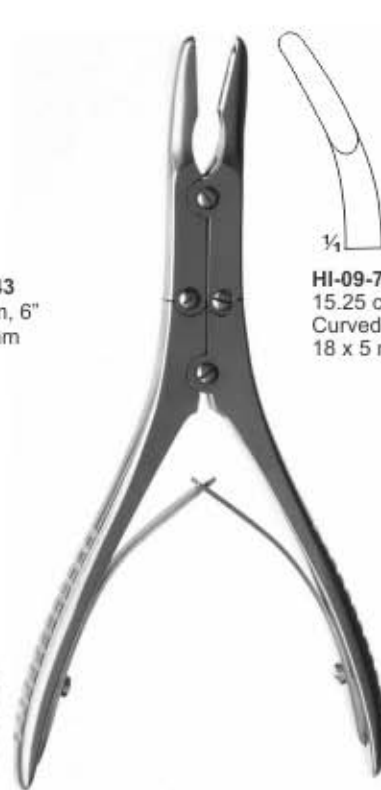

HI-09-744
15.25 cm, 6"
Curved
18 x 5 mm

Ruskin-Mini Bone Rongeur



Sybert Rongeur
HI-09-745 35.5cm 14" 4 x 16mm
HI-09-746 35.5cm 14" 8 x 16mm
HI-09-747 35.5cm 14" 12 x 16mm
HI-09-748 37cm 14 1/2" 5 x 16mm
Double action, Angled

BONE CUTTING FORCEPS

Knochensplitterzangen

Pinzas cortantes para huesos

Pinces coupantes a os

Cesoie per ossa



Cottle-Kazanjan Bone Cutting Rongeur Forceps
HI-09-749 19 cm, 7 1/2"



Littauer / Liston Bone Cutting Rongeur Forceps



HI-09-750
15 cm, 6"
Straight,



Cleveland Bone Cutting Rongeur Forceps



HI-09-751
15 cm, 6"
curved



HI-09-752
17 cm, 6 3/4"
curved



Liston Bone Cutting Rongeur Forceps



HI-09-753 14 cm, 5 1/2"
HI-09-754 17 cm, 6 3/4"
HI-09-755 19 cm, 7 1/2"
HI-09-756 20 cm 7 7/8"
HI-09-757 22 cm, 8 5/8"
Straight



Liston Bone Cutting Rongeur Forceps



HI-09-758
14 cm, 5 1/2"
Angled



HI-09-759
17 cm, 6 3/4"
Angled



HI-09-760
19 cm, 7 1/2"
Angled



HI-09-761
22 cm, 8 3/4"
Angled

BONE CUTTING FORCEPS

Knochensplitterzangen
Pincas cortantes a os

Pinzas cortantes para huesos
Cesoie per ossa



Stille-Liston Bone Cutting Rongeur Forceps



HI-09-762
27 cm, 10 3/4"
Straight



HI-09-763
27 cm, 10 3/4"
Angled 45°

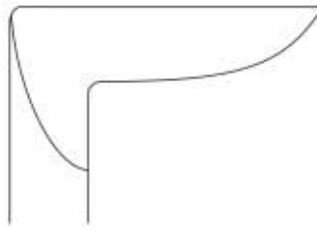

HI-09-764
27 cm, 10 3/4"
Angled 90°



Semb Bone Cutting Rongeur Forceps
HI-09-765 24 cm, 9 1/2"



Liston Key Horsley Bone Cutting Rongeur Forceps
HI-09-766 27 cm, 10 3/4"



Horsley Bone Cutting Rongeur Forceps
HI-09-767 25 cm, 10"



Ruskin Bone Cutting Rongeur Forceps
HI-09-768 20 cm, 8"
Double-Action

BONE CUTTING FORCEPS

Knochensplitterzangen
Pinces coupantes a os

Pinzas cortantes para huesos
Cesoie per ossa



HI-09-769
16 cm, 6 1/2"

Cleveland-Gardner Bone
Cutting Rongeur Forceps



HI-09-770
20 cm, 8"

Markwalder Bone Cutting
Rongeur Forceps

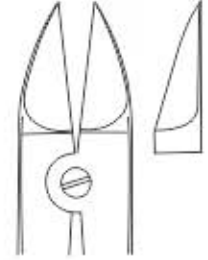

Bone Cutting Rongeur Forceps
HI-09-771 15 cm, 5 3/4"



HI-09-772
15 cm, 6"
Straight

Bohler Bone Cutting
Rongeur Forceps



HI-09-773
15 cm, 6"
Angled

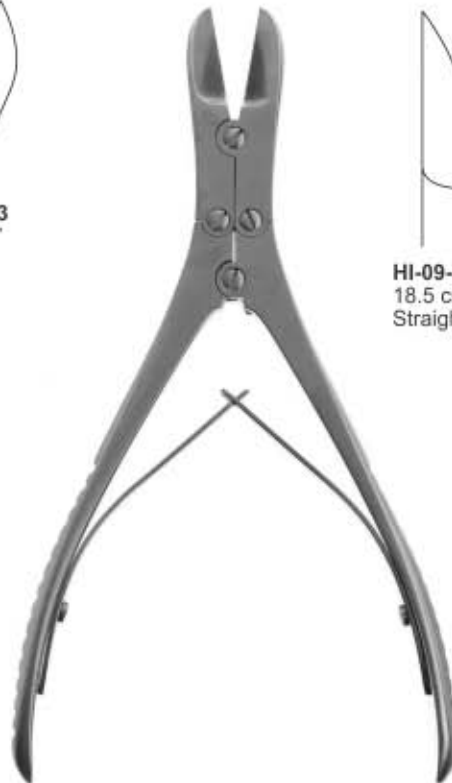

HI-09-774
18.5 cm, 7 1/4"
Straight

Ruskin-Liston Bone Cutting
Rongeur Forceps



HI-09-775
18.5 cm, 7 1/4"
Angled

BONE CUTTING FORCEPS



Knochensplitterzangen
Pinces coupantes a os

Pinzas cortantes para huesos
Cesoie per ossa

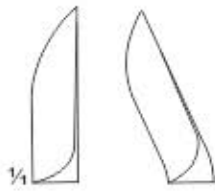

HI-09-776
15 cm, 6"
Straight

HI-09-777
15 cm, 6"
Angled

Walton-Liston Bone Cutting Rongeur Forceps



HI-09-778 19 cm, 7 1/2" Straight
HI-09-779 19 cm, 7 1/2" Curved
HI-09-780 19 cm, 7 1/2" Angled
delicate

Ruskin-Liston Bone Cutting Rongeur Forceps

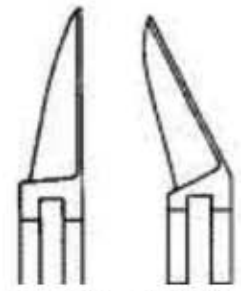
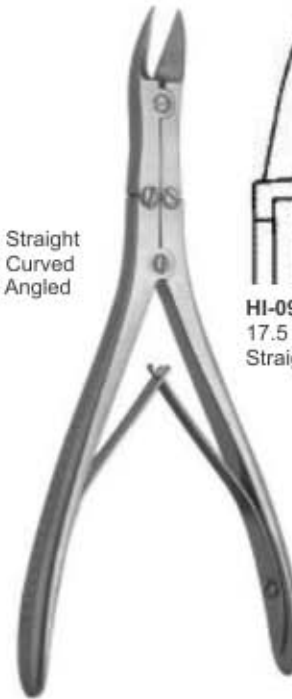

HI-09-781
17.5 cm, 7"
Straight

HI-09-782
17.5 cm, 7"
Curved

Mc Indoe Bone Cutting Rongeur Forceps



Mc Indoe Bone Cutting Forceps
HI-09-783 18 cm 7"
Angled, delicate,



Kleinert-Kutz Bone Cutting Forceps
HI-09-784 15 cm 5 5/8"
Straight, delicate,



Kleinert-Kutz Synovectomy Rongeur
HI-09-785 15cm 6" 2 x 10mm
Double action,
Curved on side, delicate,

BONE CUTTING FORCEPS

Knochensplitterzangen

Pinzas cortantes para huesos

Pinces coupantes a os

Cesoie per ossa



HI-09-786
27 cm, 10 1/2"
Straight

Stille-Liston Bone Cutting Rongeur Forceps



Stille-Horsley Bone Cutting Forceps
HI-09-787 24 cm 9 3/8"



HI-09-788
23 cm, 9"
Angled

Liston Bone Cutting Rongeur Forceps



HI-09-789
27 cm, 10 1/2"
Angled

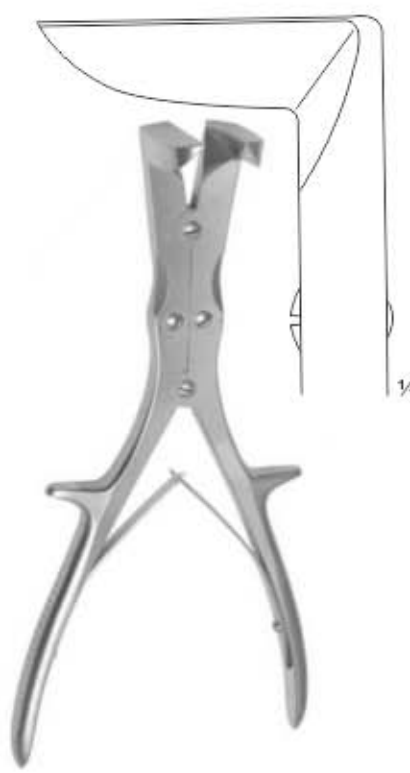

Liston-Stille Bone Cutting Rongeur Forceps
HI-09-790 26 cm, 10 1/4"

WIRE CUTTING INSTRUMENTS



Drahtschneidezangen
Pinces coupantes

Alicates para cortar alambre
Pinze taglia Filo

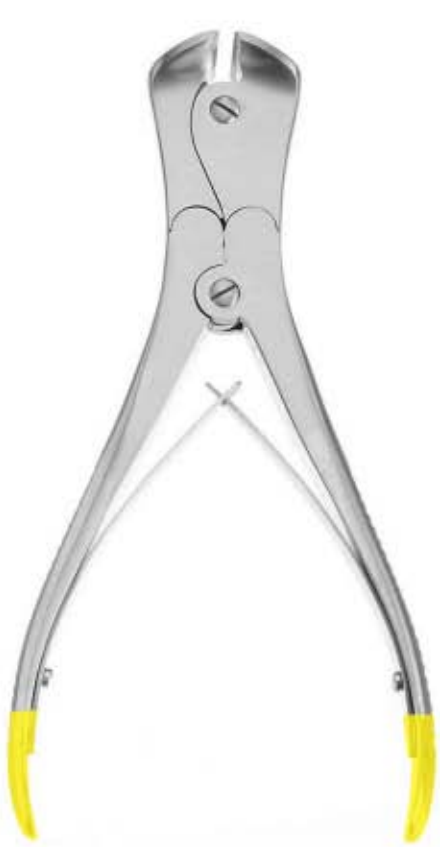

Vital Wire Cutter
HI-09-791 22cm 8 3/4"
for hard wires up to 2.2mm,
for soft wires up to 3mm



Vital Wire Cutter
HI-09-792 22cm 8 3/4"
for hard wires up to 2.2mm,
for soft wires up to 2.8mm



Vital Wire Cutter
HI-09-793 23cm 9"
for hard wires up to 2.2mm,
for soft wires up to 3mm



Vital Wire Cutter
HI-09-794 18cm 7"
for hard wires up to 1.5mm,
for soft wires up to 2mm



Vital Wire Cutter
HI-09-795 18cm 7"
for hard wires up to 1.7mm,
for soft wires up to 2mm



Vital Wire Cutter
HI-09-796 15cm 6"
for hard wires up to 1mm,
for soft wires up to 1.5mm



Vital Wire Cutter
HI-09-797 14.5cm 5 3/4"
for hard wires up to 1mm,
for soft wires up to 1mm



Side Cutter

HI-09-798 18.5cm 7 1/4"
Welded carbide jaws
max capacity. 1.6mm 062"



Delicate Wire Cutter

HI-09-799 12.5cm 4 7/8"
Side cutting w/ carbide inserts
max capacity. 0.7mm 028"



Front & Side Wire Cutter

HI-09-800 17cm 6 3/4"
Front and side cutting w/ carbide inserts,
double action. Max capacity. 1.6mm 062"



Double Action Wire Cutter

Angled. Side cutting w/ carbide inserts
HI-09-801 17cm 6 5/8"
max cap 1.6mm 062"
HI-09-802 21.5cm 8 1/2"
max cap. 2.4mm 3/32"



Flush Wire Cutter

HI-09-803 17cm 6 3/4"
Front and side cutting w/ carbide inserts,
double action. Max capacity. 1.5mm 059"



Wire Forceps

HI-09-804 17 cm 6 1/2"
Straight, serrated 5.4 mm tip

WIRE CUTTING INSTRUMENTS



Drahtschneidezangen
Pinces coupantes

Alicates para cortar alambre
Pinze taglia Filo



Stille Plaster Shear
HI-09-805
37cm 14 1/2" 9" to 15"



Schumacher Sternum Shears
HI-09-806 21cm 8 1/4"



Kirschner Wires & Steinmann Pins Cutter
HI-09-807 57cm 22 1/2"
up to 6mm



Cannulated Wire / Pin Cutter
HI-09-808 19 cm 7 1/2"
Cuts wire upto 1.6 mm



Hard Wire Cutter Cuts
HI-09-809 26.0cm 10 1/4"
for hard wires up to 3mm



Side Pin Cutter
HI-09-810 57.5cm 22 5/8"
Side cutting w/ carbide inserts
max. cap: 5/32"



Pin Cutter Small
HI-09-811 26cm 10 1/4"
Max cap: 3.2mm



Pin Cutter Medium
HI-09-812 36.5cm 14 3/8"
Max cap: 4.7mm,



Large Pin Cutter
HI-09-813 57.5cm 22 5/8"
Large, Straight, Max.
capacity 6.3mm 1/4"

BONE HOLDING CLAMPS - BONE HOLDING FORCEPS

Knochenhalteklammern - Knochenhaltezangen | Pinzas porta huesos - Pinzas para huesos
 Daviers a os - Daviers porte-so | Tenaglie per ossa



Gerster-Lowmann Bone Clamp

HI-09-814 12.1cm, 4.75"
 HI-09-815 14.5cm 5 5/8"
 HI-09-816 18cm, 7", 28mm
 HI-09-817 20cm, 8", 35mm
 HI-09-818 22cm, 8 3/4", 40mm
 1x2 Jaws



Lowmann Bone Clamp

HI-09-818 A 12cm
 HI-09-818 B 15cm
 HI-09-818 C 17cm
 HI-09-818 D 18.5cm
 HI-09-818 E 20cm



Lambert-Lowman Bone Clamp

HI-09-819 17.5 cm, 7"
 HI-09-820 20.3 cm, 8"
 2x2 Jaws

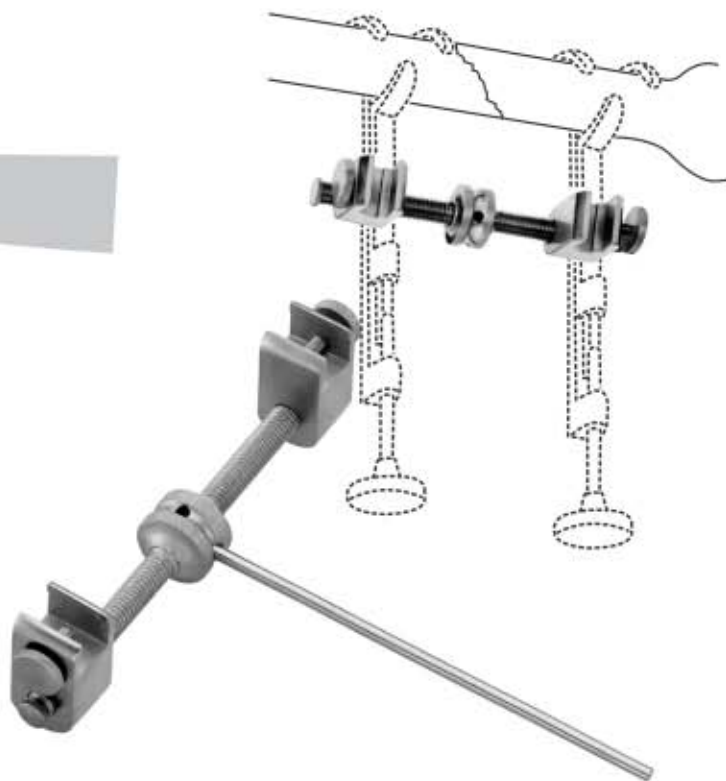

Gerster Bone Holding Clamp

HI-09-821 15cm, 6"



Gerster Bone Holding Clamp
 HI-09-822



Gerster Bone Holding Clamp
 HI-09-823



Parham-Martin Bone Clamp
 HI-09-824
 21cm 8 1/4"
 Straight



Parham Martin Bands
 HI-09-825
 19.0cm 7 1/2"



Bone Reduction Forceps
 HI-09-826 13.5cm, 5 1/4"

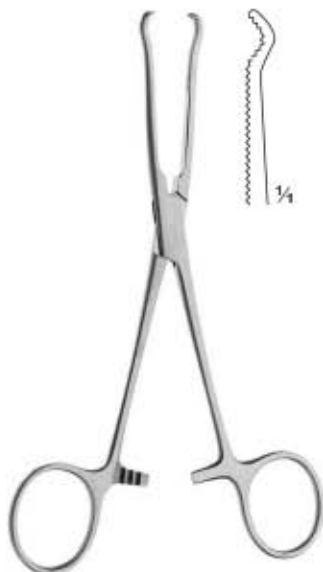

Locke Phalangeal Forceps
 HI-09-827 14cm, 5 1/2"



Lewin Perforating Bone Holding Forceps
 HI-09-828 17.5cm, 7"
 serrated



Stagbeetle Bone Reduction Forceps
 HI-09-829
 Pointed tips, 13 cm 4 7/8"



HI-09-830
 13.5 cm, 5 1/2"
 Angled Serrated

Bone Reduction Orthopedic Forceps



Shoulder Percussion Awl
 Pointed, 21.6cm 8 1/2"
 HI-09-831 Small
 HI-09-832 Medium
 HI-09-833 Large
 HI-09-834 Pointed, 23.5cm 9 1/4"

BONE HOLDING FORCEPS



Knochenhaltezaugen
Daviers porte-so

Pinzas para huesos
Tenaglie per ossa



Meniscus Clamp
HI-09-835 13.5cm 5 3/8"
Serrated

Meniscus Clamp
HI-09-836 13.5cm 5 3/8"
Angled 20°, serrated

**Preston Logamentum
Flavum Forceps**
HI-09-837 19 cm 7-1/4"
Curved, 1 x 2 teeth



Meniscus Clamp
HI-09-838 18cm 7 1/8"
Straight, Curved shaft



Dingman Bone Clamp
HI-09-839 19cm 7 1/2"
Straight, Serrated,
1 1/2" tip length,
Curved shaft



Fergusson Bone Holding Forceps
HI-09-840 21.0 cm, 8 1/4"
2 x 2 teeth



Van Buren Sequestrum Forceps
HI-09-841 23.0 cm, 9"
Curved on side, serrated



Langenbeck Bone Holding Forceps
HI-09-842 21 cm, 8 1/4"

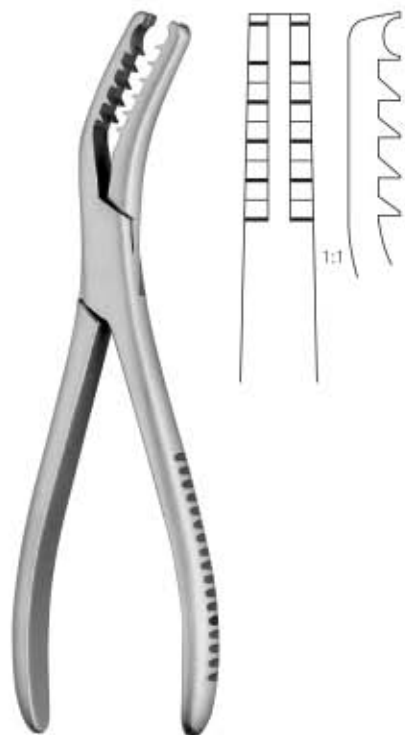

Semb Bone Holding Forceps
HI-09-843 19 cm, 7 1/2" without ratchet
curved sideways deep teeth



Semb Bone Holding Forceps
HI-09-844 20.3cm, 8", with ratchet
curved sideways deep teeth

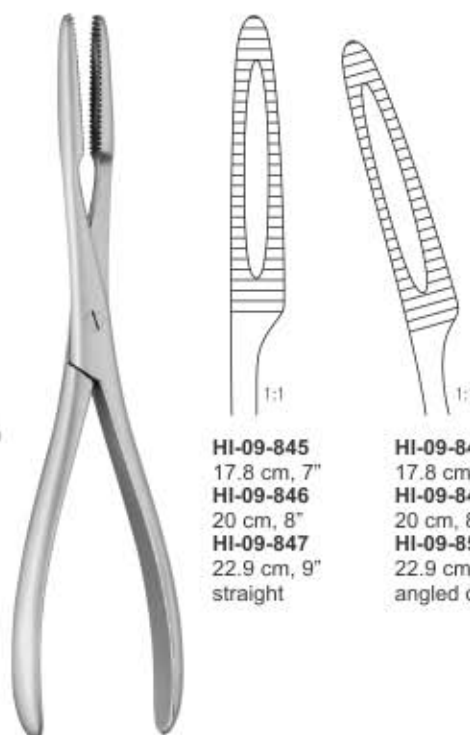

Sequestrum (Nircosis) Bone Holding Forceps

HI-09-845 17.8 cm, 7"
HI-09-846 20 cm, 8"
HI-09-847 22.9 cm, 9"
straight

HI-09-848 17.8 cm, 7"
HI-09-849 20 cm, 8"
HI-09-850 22.9 cm, 9"
angled on flat

BONE HOLDING FORCEPS



Knochenhaltezaugen
Daviers porte-so

Pinzas para huesos
Tenaglie per ossa

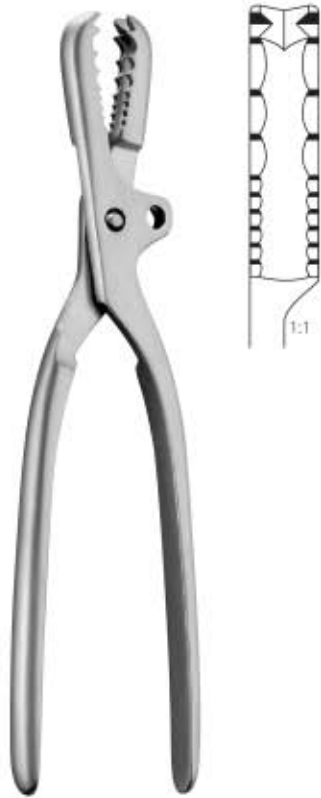

Farabeuf Bone Holding Forceps
HI-09-851 23 cm, 9"
HI-09-852 26 cm, 10 1/4"
with adjustable jaw



Farabeuf-Lambotte Bone Holding Forceps
HI-09-853 26 cm, 10 1/4"
with adjustable jaw

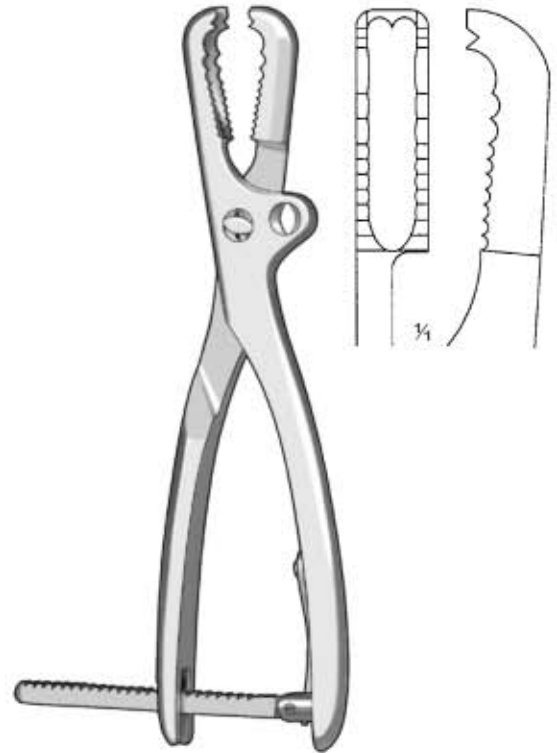

Farabeuf-Lambotte Bone Holding Forceps
HI-09-854 26 cm, 10 1/4"
with adjustable jaw



Bishop Bone Clamp
HI-09-855 22.5cm 8 7/8"
Straight



Kern Bone Holding Forceps
HI-09-856 17 cm, 6 3/4"
HI-09-857 24 cm, 9 1/2"
without ratchet



Kern Bone Holding Forceps
HI-09-858 17 cm, 6 3/4"
HI-09-859 24 cm, 9 1/2"
with ratchet

BONE HOLDING FORCEPS

Knochenhaltezangen
Daviers porte-so

Pinzas para huesos
Tenaglie per ossa



Hey Groves Bone Holding Forceps

HI-09-860 21 cm, 8 1/4"
HI-09-861 27 cm, 10 3/4"
HI-09-862 30. cm, 12"



Lane Bone Holding Forceps

Light Model

HI-09-863 33 cm 13" 11 mm tip W/ Ratchet
HI-09-864 33 cm 13" 13 mm tip W/ Ratchet
HI-09-865 43 cm 17" 13.5 mm tip W/ Ratchet
HI-09-866 13 cm 13" 10 mm tip W/o Ratchet



3/4



Lane Bone Holding Forceps

HI-09-867 33 cm 13" 13 mm tip
HI-09-868 43 cm 14" 12 mm tip
without ratchet



1:1



Ulrich Bone Holding Self Retaining Forceps

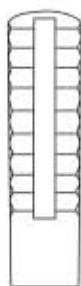

HI-09-869 18 cm, 7" mini
HI-09-870 22 cm, 8 1/2"
HI-09-871 26 cm, 10"
HI-09-872 28 cm, 11"
Straight with speed lock



Ulrich Bone Holding Forceps



HI-09-873 18 cm, 7"
HI-09-874 22 cm, 8 1/2"
HI-09-875 26 cm, 10"
HI-09-876 28 cm, 11"
Angular, with speed lock



Ulrich Bone Holding Forceps

HI-09-877 28 cm 11"
Angular With Speed Lock
& swivel jaw

BONE HOLDING FORCEPS

Knochenhaltezaugen
Daviers porte-so

Pinzas para huesos
Tenaglie per ossa



Lambotte Bone Holding Forceps

HI-09-878 22 cm, 8 3/4"
HI-09-879 27 cm, 10 3/4"
HI-09-880 30 cm, 12"
One Jaw Mobile
adjustable jaw

Lambotte Bone Holding Forceps

HI-09-881 15 cm, 6", 2.5mm
HI-09-882 19 cm, 7 1/2", 6.5mm
HI-09-883 24 cm, 9 1/2", 9.5mm
HI-09-884 26 cm, 10 1/4", 10mm
HI-09-885 28 cm, 11", 11
Self-Centering, with speed lock

BONE HOLDING FORCEPS

Knochenhaltezaugen

Pinzas para huesos

Daviers porte-so

Tenaglie per ossa



Subacromion Spreader

HI-09-886 26.75cm 10.5" Right

HI-09-887 26.75cm 10.5" Left



Bone Reduction Forceps

HI-09-888 14 cm 5 1/2" Curved

HI-09-889 15 cm 6" Serrated



**Bone Reduction Forceps,
Pointed Tips**

HI-09-890 14 cm 5 1/2" Serrated

HI-09-891 14 cm 5 1/4" Curved

HI-09-892 17 cm 6 3/4" Curved



**Lane Bone Holding
Forceps**

HI-09-893 31.5 cm

HI-09-894 39 cm



Bone Reduction Forceps

HI-09-895 14 cm 5 1/4"

Serrated with pointed tips



Semb Bone Holding Forceps

Curved on side

HI-09-896 19 cm 7 1/2" 4 x 5 teeth

HI-09-897 21 cm 8" 5 x 5 teeth

BONE HOLDING FORCEPS



Knochenhaltezangen | Pinzas para huesos
 Daviers porte-so | Tenaglie per ossa



Martin Cartilage Bone Holding Clamp Forceps
 HI-09-898 19 cm, 7 1/2" Str.

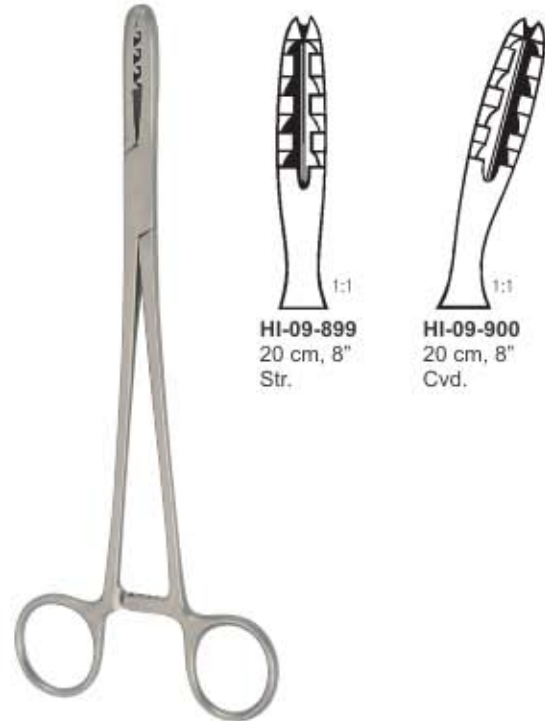

HI-09-899
 20 cm, 8" Str.

HI-09-900
 20 cm, 8" Cvd.



Verbrugge Bone Holding Forceps

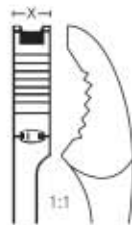

HI-09-901
 17.5 cm, 7"
 5.0mm

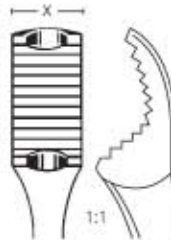

HI-09-902
 25 cm, 10"
 9.5mm

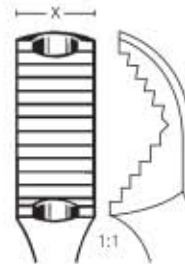

HI-09-903
 26 cm, 10 1/4"
 10.5mm

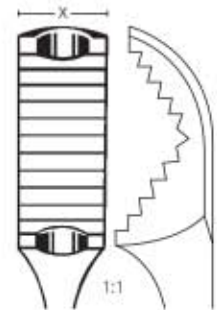

HI-09-904
 27 cm, 10 3/4"
 12.0mm

BONE HOLDING FORCEPS

Knochenhaltezaugen | *Pinzas para huesos*
Daviers porte-so | *Tenaglie per ossa*



Verbrugge Bone Holding Forceps

- HI-09-905 18 cm 7"
 - HI-09-906 26 cm 10"
 - HI-09-907 27 cm 10 1/2"
 - HI-09-908 28 cm 11"
- W/ Long Ratchet



Vebrugge Self-Centering Bone Holding Forceps

- HI-09-909 15 cm 5 3/4"
 - HI-09-910 19 cm 7 1/4"
 - HI-09-911 24 cm 9 1/4"
 - HI-09-912 26 cm 10"
 - HI-09-913 29 cm 11 1/4"
- with long ratchet

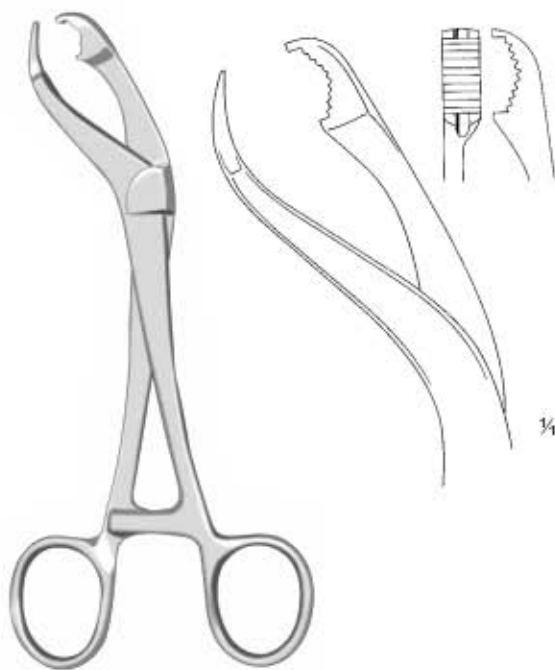

Verbrugge Bone Holding Forceps

- HI-09-914 17.2cm, 6.75"
- with short ratchet



Lane Bone Plate Holding Forceps

- HI-09-915 22cm 8 3/4"

BONE HOLDING FORCEPS



Knochenhaltezaugen
Daviers porte-so

Pinzas para huesos
Tenaglie per ossa



Verbrugge Bone Holding Forceps
HI-09-916 18 cm, 7"



Verbrugge Bone Holding Forceps
HI-09-917 18 cm, 7"



Verbrugge Bone Holding Forceps
HI-09-918 25 cm, 10"
HI-09-919 26 cm, 10 1/4"
HI-09-920 27 cm, 10 1/2"

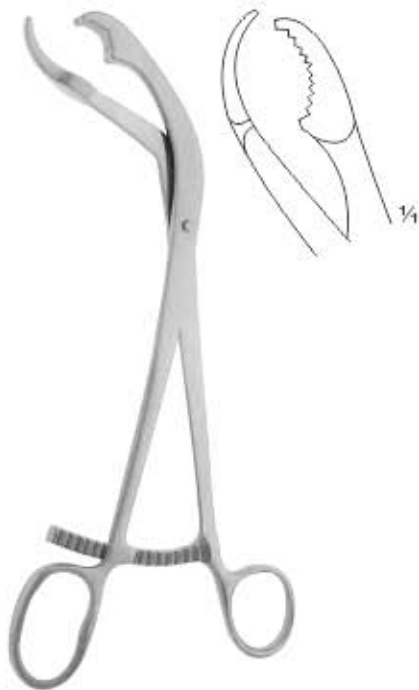

Verbrugge Bone Holding Forceps
HI-09-921 25 cm, 10"
HI-09-922 26 cm, 10 1/4"
HI-09-923 27 cm, 10 1/2"



Verbrugge Bone Holding Forceps
HI-09-924 18 cm, 7"



Verbrugge Bone Holding Forceps
HI-09-925 25 cm, 10"
HI-09-926 26 cm, 10 1/4"
HI-09-927 27 cm, 10 1/2"



Bone Reduction Forceps
HI-09-928 13.5 cm, 5 1/4"



Reill Bone Reduction Forceps
HI-09-929 17 cm 6 3/4"
Curved, pointed tips



Bone Reduction Forceps
HI-09-930 20.4 cm, 8"
Pointed tips



Bone Reduction Forceps
HI-09-931 13.5 cm, 5"
for maxillary reposition



Haase
HI-09-932
16.5 cm, 6 1/2"
for mandibular
fractures



HI-09-933
9.5 cm, 3 3/4"

HI-09-934
9.5 cm, 3 3/4"

Bone Holding forceps

BONE HOLDING FORCEPS

Knochenhaltezaugen
Daviers porte-so

Pinzas para huesos
Tenaglie per ossa



Fibula Bone Holding Forceps
HI-09-935
22 cm 8 1/2"



Glenoid Perforating Forceps
HI-09-936 17 cm 6 1/2"
Lightly curved, pointed tips
Strongly curved, pointed tips



Reil Bone Holding Forceps
HI-09-937 17 cm, 7"



Bone Reduction Forceps
HI-09-938 20 cm, 8"
with Points



Malleolar Bone Holding Forceps
HI-09-939 21 cm 8 1/4"
Straight, 1 x 1 teeth

BONE HOLDING FORCEPS

Knochenhaltezaugen
Daviers porte-so

Pinzas para huesos
Tenaglie per ossa



Patella Malleolar Forceps
HI-09-940 21.0 cm, 8 1/4"



Reduction Forceps
HI-09-941 16 cm, 6 1/2"
HI-09-942 24 cm, 9 1/2"
with Thread Lock



Reposition Forceps
HI-09-943 23 cm, 9"



Pelvic Reposition Forceps
HI-09-944 19 cm, 7 1/2"



Pelvic Reposition Forceps
HI-09-945 23 cm, 9"



Pelvic Reposition Forceps
HI-09-946 25 cm, 10"

BONE HOLDING FORCEPS

Knochenhaltezaugen
Daviers porte-so

Pinzas para huesos
Tenaglie per ossa



Pelvic Reposition Forceps
HI-09-947 25 cm, 10"
3 Balls Spikes



Pelvic Reposition Forceps
HI-09-948 40 cm, 15 3/4"



Pelvic Reposition Forceps
HI-09-949 40 cm, 15 3/4"



Pelvic Reduction Forceps Asymmetric
HI-09-950 25 cm, 10"
with 3 ball Spikes



Pelvic Reduction Forceps Asymmetric
HI-09-951 25 cm, 10"



Pelvic Reduction Forceps Asymmetric
HI-09-952 40 cm, 15 3/4"

HAND DRILLS

Handbohrapparate
Perforateurs a main

Perforadores de mano
Perforatori a mano



Moore Drill And Bit Set Complete
HI-09-953



Stille Pattern Drill Set
HI-09-954
Complete set of stainless
drill bits and burrs



Fig. 1
HI-09-955
2.5mm

Fig. 2
HI-09-956
3.0mm

Fig. 3
HI-09-957
3.5mm

Fig. 4
HI-09-958
4.0mm



Fig. 5
HI-09-959
5.0mm

Fig. 6
HI-09-960
8.0mm

Fig. 7
HI-09-961
12.0mm

Fig. 8
HI-09-962
16.0mm



Fig. 09
HI-09-963

Fig. 10
HI-09-964
1:2
1.0mm

Fig. 11
HI-09-965
1:2
1.5mm

Fig. 12
HI-09-966
1:2
2.0mm

HAND DRILLS

Handbohrapparate
Perforateurs a main

Perforadores de mano
Perforatori a mano

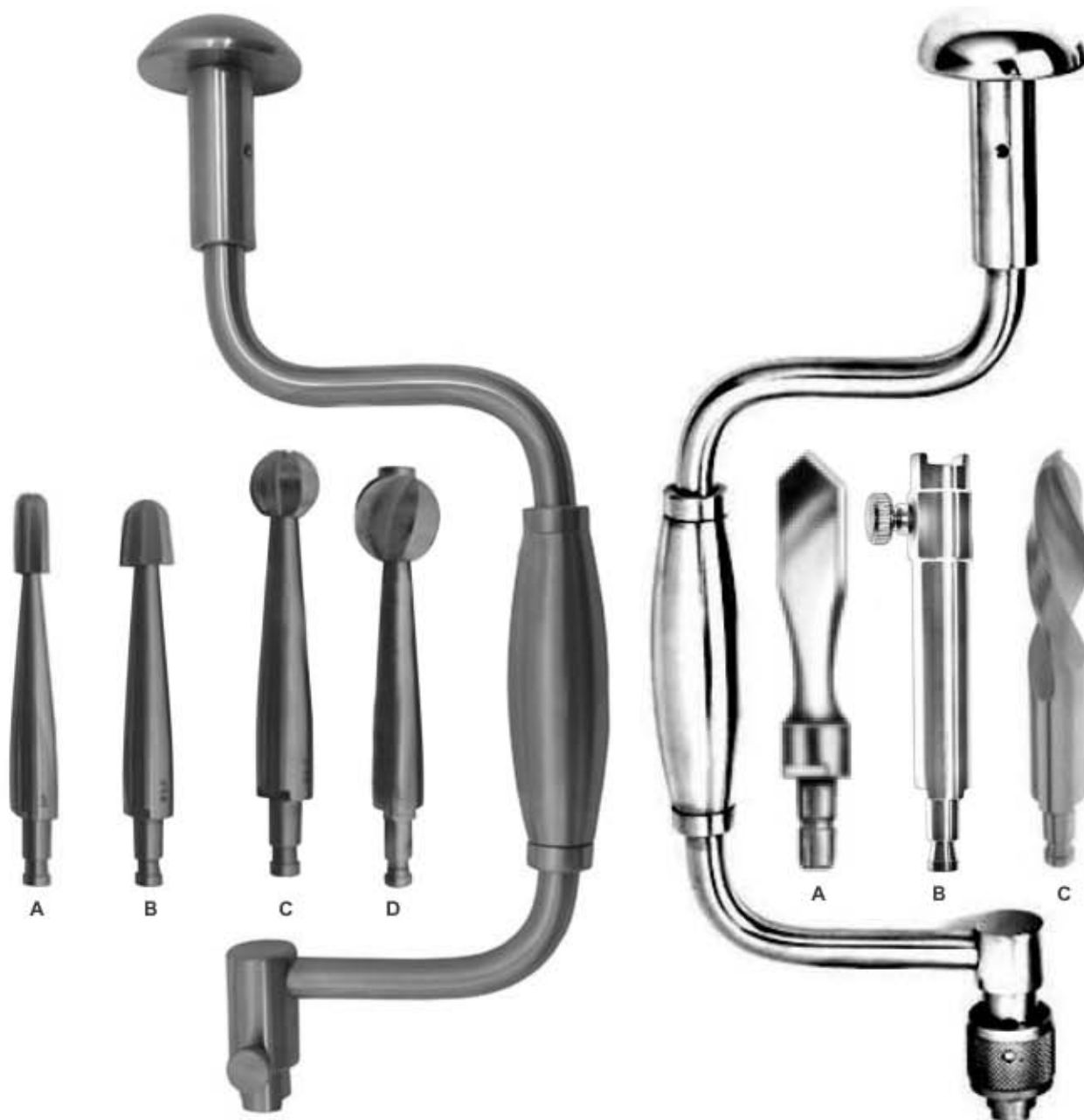

HI-09-967
Hudson Brace 10 1/2" (26.7cm),
with standard thumb screw chuck

- A HI-09-968 Hudson Bur, 9mm Diameter
- B HI-09-969 Hudson Bur, 14mm Diameter
- C HI-09-970 Hudson Bur, 16mm Diameter
- D HI-09-971 Hudson Bur, 22mm Diameter

HI-09-972
Hudson Brace 11" (27.9cm),
with Improved Snap-Lock chuck

- A HI-09-973 Cushing Perforator, for Hudson Brace
- B HI-09-974 Hudson Cerabellar Extension, 4" for Hudson Brace
- C HI-09-975 McKenzie Perforator for Hudson Brace



Jacobs
HI-09-976 28cm 11"
opening up to 6.35mm



Hand Drill
HI-09-977
opening up to 6.35mm



T-Handle
HI-09-978
AO Coupling



Jacob's Chuck
HI-09-979 T-Handle and key
HI-09-980 only
HI-09-981 Key



Key Handle
HI-09-982



T-Handle
HI-09-983
for AO Coupling



Memoral Head Extractor
HI-09-984



HEXAGONAL HEAD

	Size of screws	Head Size	Fiber-Handle	AO Coupling	Dental Coupling
A	1.5mm	1.5mm	HI-09-985	HI-09-988	HI-09-991
B	2.0mm				
C	2.7mm				
D	3.5mm	2.5mm	HI-09-986	HI-09-989	
E	4.0mm				
F	4.5mm	3.5mm	HI-09-987	HI-09-990	
G	6.5mm				

Spiralbohrer - Pfieme - zangen
Meches - Alenes - Daviers

Taladros espirales - Escariadores - Pinzas
Punte a spirale - Perforatori a mano - Tenaglie



Parallel Target Device
HI-09-992
for guide wires 2mm



Mortising Chisel
HI-09-993



Wire Guide
HI-09-994
45mm



Wire Guide
HI-09-995
70mm



Countersink
HI-09-996



Countersink
HI-09-997



Countersink
HI-09-998



Perthes
HI-09-999 18cm 7"
HI-09-1000 21cm 8 1/4"



HI-09-1001
14cm 5 1/2"



HI-09-1002
14cm 5 1/2"



Mini Drill Sleeve
HI-09-1003
 1.1 mm and 1.5 mm drill bits
HI-09-1004
 1.5 mm and 2.0 mm drill bits

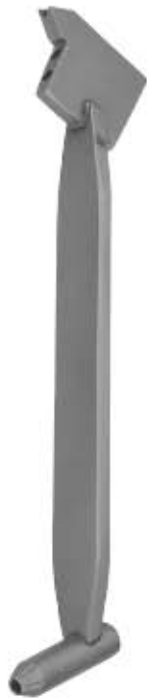

Drill Guide
HI-09-1005
 drill sleeve for 2.0 mm
 drill bit



HI-09-1006 Tap Sleeve, 2.0 mm \varnothing
HI-09-1007 Drill Sleeve, 2.7 mm \varnothing
HI-09-1008 Tap Sleeve, 2.5 mm \varnothing
HI-09-1009 Drill Sleeve, 3.5 mm \varnothing



Neutral & Load Drill Guide
HI-09-1010 1.5 mm for 2.0 mm Screws
HI-09-1011 2.0 mm for 2.7 mm Screws
HI-09-1012 2.5 mm for 3.5 mm Screws
HI-09-1013 3.2 mm for 4.5 mm Screws

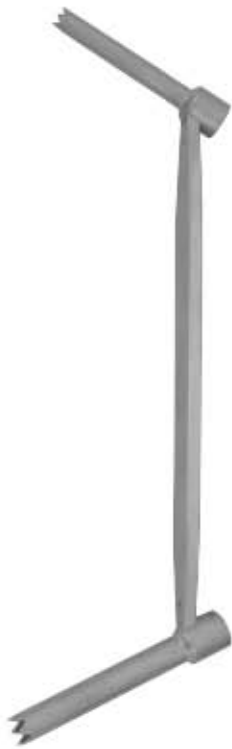

Tap Sleeve
HI-09-1014
 3.5 mm



Tap Sleeve
HI-09-1015
 3.5 mm also for used
 as 3.2 mm drill Guide



Tap Sleeve
HI-09-1016
 4.5 mm



Drill Sleeve
HI-09-1017
 3.2 mm for Round
 Hole Plates



Insert Drill Sleeve

- HI-09-1018 2.7 / 2.0 mm Drill Bit 2.0 mm
- HI-09-1019 3.5 / 2.5 mm Drill Bit 2.5 mm
- HI-09-1020 4.5 / 3.2 mm Drill Bit 3.2 mm



Drill Small Pointed

- HI-09-1021
- Drill Bit 3.5 mm



Drill Pointed Guide

- HI-09-1022
- 6.5 mm



Drill Pointed Guide

- HI-09-1023
- 6.5 mm



Drill Guide

- HI-09-1024
- 4.5 mm Screws
- Drill Bit 4.5 mm & 3.2 mm



Drill Guide

- HI-09-1025
- 6.5 mm Screws
- Drill Bit 3.2 mm



Drill Guide

- HI-09-1026
- 3.5 mm for neutral and compression Positioning
- Drill Bit 2.5 mm



C - Clamp

- HI-09-1027
- Drill Guide with thread for Drill Bit 4.5 mm

WIRE INSTRUMENTS



Draht-Instrumentarium
Instruments pour cerclage

Instrumental para cerclaje
Strumenti per filo di cerchiaggio



Bending Device
HI-09-1028
21.5cm 8 1/4"
to bend straight
and angled plates



Rod Bender
HI-09-1029
to bend straight
and angled



Universal Rod Bender
HI-09-1030
28.5cm 11 1/4"
to bend straight
and angled



Rod Bender
HI-09-1031
to bend straight
and angled



Slotted Hammer
HI-09-1032 14mm



Plate Bender
HI-09-1033



Plate Bender
HI-09-1034



Plate Bender
HI-09-1035



Plate Bender
HI-09-1036

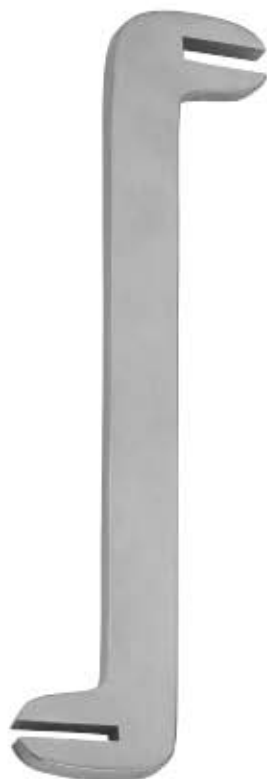

Plate Bender
HI-09-1037



Plate Bender
HI-09-1038



Plate Bender
HI-09-1039

EXTENSION BOWS



Extensionsbugel
Etriers pour extension

Estribos para extension
Archi per estensione



HI-09-1040 18cm, 7"
Wire strainer for
kirschner wires



Kirschner Extension Bows
HI-09-1041 x=95mm y=70mm
HI-09-1042 x=100mm y=100mm
HI-09-1043 x=120mm y=120mm
HI-09-1044 x=155mm y=155mm
HI-09-1045 x=200mm y=155mm
 with 3 traction hooks



Kirschner Extension Bows
HI-09-1046 x=130mm
HI-09-1047 x=185mm
HI-09-1048 x=220mm
 with 3 traction hooks



Wrench
Kirschner
Extension Bows
HI-09-1049
 14mm/17mm

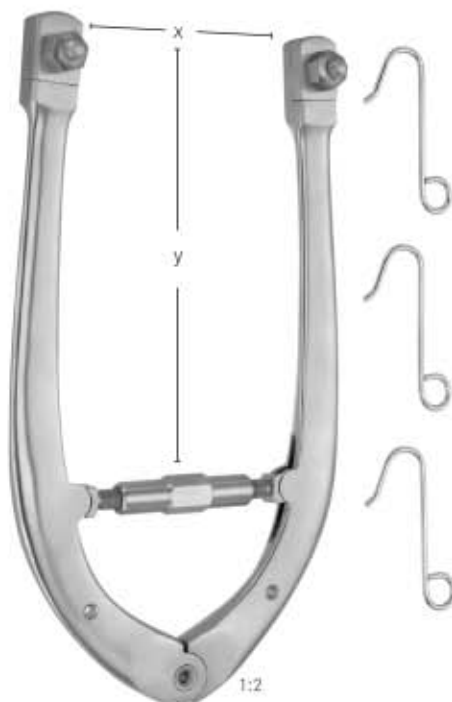

Kirschner Extension Bows
HI-09-1050 x=180mm y=100mm
HI-09-1051 x=270mm y=160mm
 with 3 traction hooks

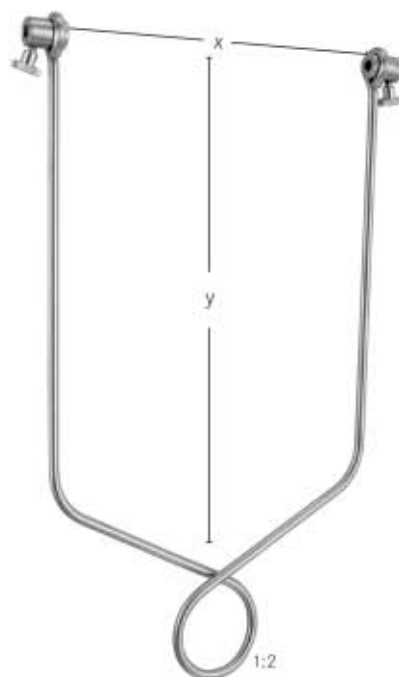

Bohler Kirschner Extension Bows
HI-09-1052 x=75mm y=90mm
HI-09-1053 x=90mm y=160mm
HI-09-1054 x=110mm y=210mm
HI-09-1055 x=150mm y=210mm
 with 3 traction hooks



Charnley-mueller
HI-09-1056
 Compression Clamp



Screw Depth Gauges

- HI-09-1057 Mini Gauge, 4 3/4" Long measures up to 30mm
- HI-09-1058 Small Gauge, 6 1/4" Long measures up to 50mm
- HI-09-1059 Large Gauge, 8 3/4" Long measures up to 100mm
- HI-09-1060 X-Large Gauge, 11" Long measures up to 120mm



Screw Depth Gauges

- HI-09-1061 Mini Gauge, 4 3/4" Long measures up to 30mm
- HI-09-1062 Small Gauge, 6 1/4" Long measures up to 50mm
- HI-09-1063 Large Gauge, 8 3/4" Long measures up to 100mm
- HI-09-1064 X-Large Gauge, 11" Long measures up to 120mm

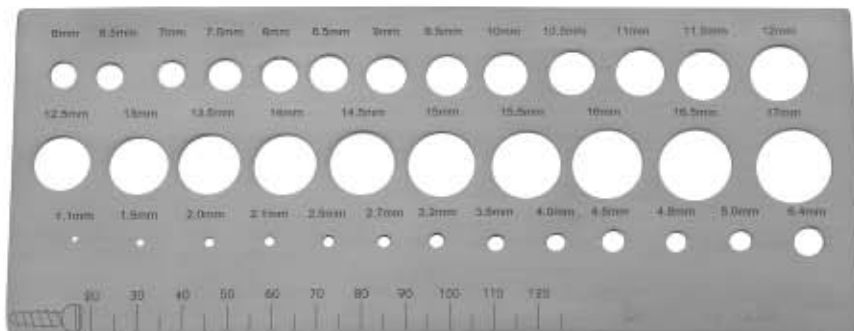

**Measuring Gauge
HI-09-1065
for nail**

HI-09-1066 Tri Angular Positioning Plate A, B, C, D

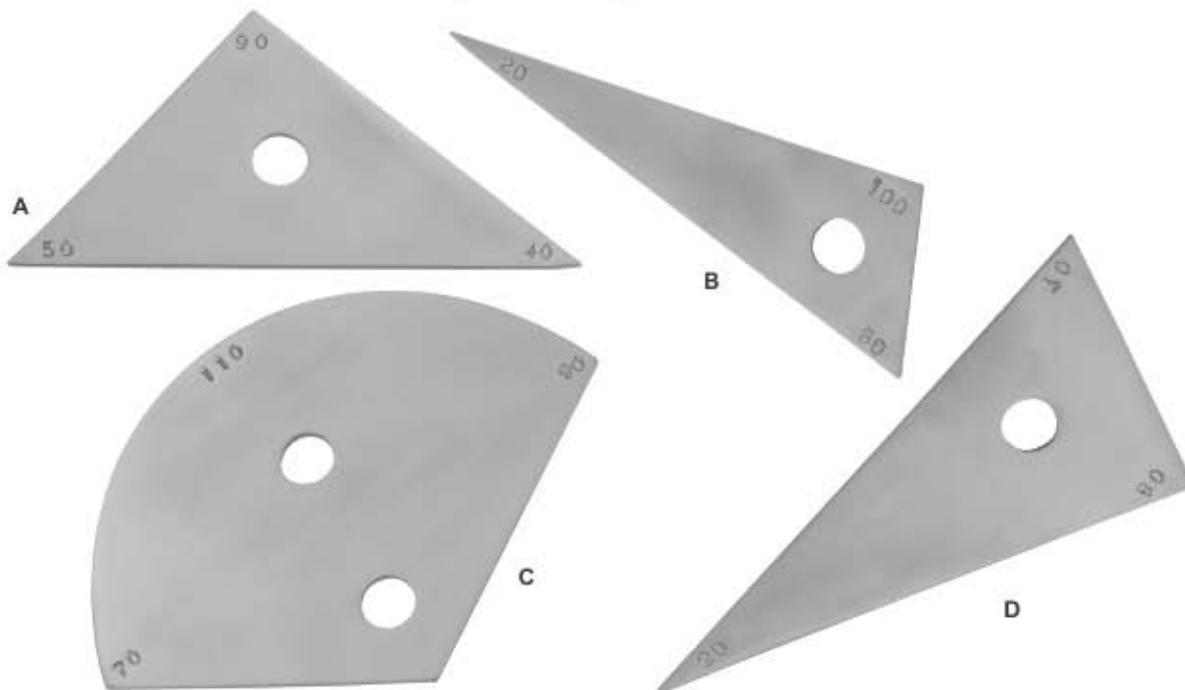

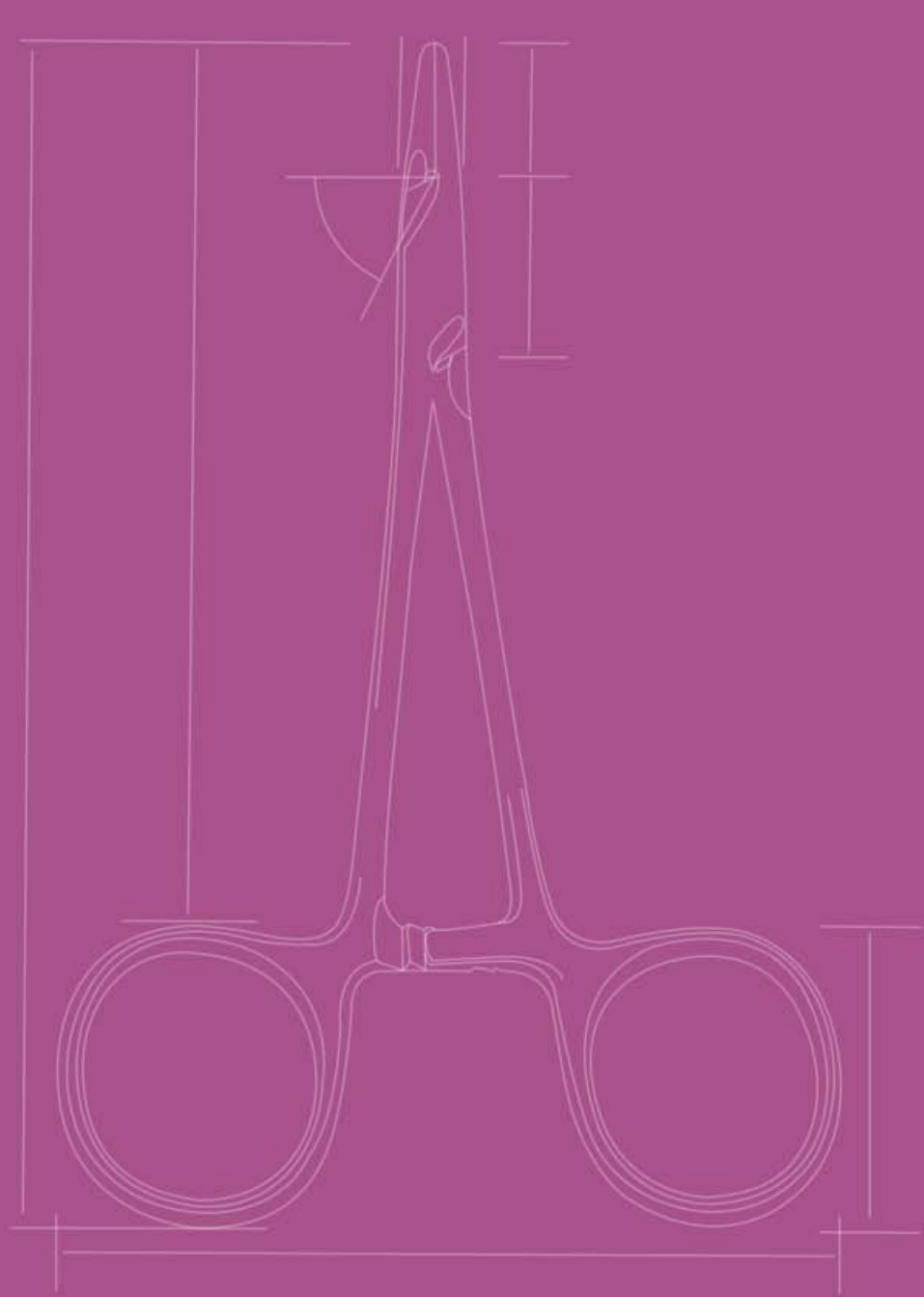

HOMEDICA
INTERNATIONAL